



# JAY<sup>®</sup> Zip Pediatric Backrest

E2613

February 2023

**Mark For:**

**Submitting for:**

Quote  Order

Date: \_\_\_\_\_  
 Dealer Acct #: \_\_\_\_\_  
 Dealer: \_\_\_\_\_  
 Dealer Contact: \_\_\_\_\_  
 Dealer Address: \_\_\_\_\_  
 Dealer City: \_\_\_\_\_ ST: \_\_\_\_\_ ZIP: \_\_\_\_\_  
 Dealer Phone: ( ) \_\_\_\_\_ Fax: ( ) \_\_\_\_\_  
 Confirmation Email: \_\_\_\_\_  
 Confirm Via:  Fax  Email

PO#: \_\_\_\_\_

**ADDITIONAL SHIPPING INFORMATION**

Ship To: \_\_\_\_\_  
 Attention: \_\_\_\_\_  
 Address: \_\_\_\_\_  
 Address: \_\_\_\_\_  
 Ship To City: \_\_\_\_\_ ST: \_\_\_\_\_ ZIP: \_\_\_\_\_  
 Ship To Phone: ( ) \_\_\_\_\_ Fax: ( ) \_\_\_\_\_

The **HCPCS CODES** herein are based on PDAC verification or interpretation of Medicare definitions and guidelines. Non-Medicare payers may accept alternative **HCPCS CODES**, including misc. codes to ensure access for their enrollees. The use of **HCPCS CODES** does not ensure coverage or payment.

**JAY ZIP BACK - E2613**

<input type="checkbox"/>	JZIPBXXY	E2613	JAY Zip Backrest All Sizes	\$564.00
--------------------------	----------	-------	----------------------------	----------

NOTE: Select appropriate assembly number below.  
 165 lbs Weight Capacity

<b>EACH BACK SHIPS WITH THE FOLLOWING:</b>
Ultra lightweight mounting hardware
2" of anterior depth adjustment, 2.75" with reversing mounting pins
10mm Combo Wrench
4mm Hex Key
Neoprene Backrest Hardware Covers (Allows for quick release)
Water resistant inner cover & Ionic+™ outer cover
Adjustable lumbar support



BACKREST WIDTH	8"	10"	12"	14"
FITS BACK CANE WIDTHS	8"-9"	10"-11"	12"-13"	14"-15"
MAX. USER TRUNK WIDTH	7"	9"	11"	13"
ACTUAL SHELL WIDTH	5.6"	7.6"	9.6"	11.6"
DEPTH OF CONTOUR	1"	1.5"	2"	2.5"

		Backrest Width			
		8"	10"	12"	14"
Backrest Height	6" (S)	<input type="checkbox"/> JZIPB08S	<input type="checkbox"/> JZIPB10S	<input type="checkbox"/> JZIPB12S	<input type="checkbox"/> JZIPB14S
	8" (M)	<input type="checkbox"/> JZIPB08M	<input type="checkbox"/> JZIPB10M	<input type="checkbox"/> JZIPB12M	<input type="checkbox"/> JZIPB14M
	10" (T)	<input type="checkbox"/> JZIPB08T	<input type="checkbox"/> JZIPB10T	<input type="checkbox"/> JZIPB12T	<input type="checkbox"/> JZIPB14T
	12" (X)	<input type="checkbox"/> JZIPB08X	<input type="checkbox"/> JZIPB10X	<input type="checkbox"/> JZIPB12X	<input type="checkbox"/> JZIPB14X

The JAY ZIP Backrest has been dynamically tested and meets all criteria for use in motor vehicles according to Section 5.1 of ISO 16840-4 and Section 20, ANSI/RESNA WC/Volume 4.  
 Please visit [www.sunparts.us](http://www.sunparts.us) for spare parts information.

## JAY ZIP BACK ACCESSORIES

*JAY ZIP Back accessories are optional. All accessories will be factory mounted as much as possible to ensure proper shipping.*

### LATERAL SUPPORTS

*Use this section for lateral supports.*

#### FIXED LATERAL THORACIC SUPPORT

*Includes fixed mounting hardware.*

<input type="checkbox"/>	JZFX34F	E0956	LAT ZIP FIXED 3X4 FLAT	\$279.00	<input type="checkbox"/>	JZFX34C	E0956	LAT ZIP FIXED 3X4 CURVE	\$290.00
<input type="checkbox"/>	JZFX45F	E0956	LAT ZIP FIXED 4X5 FLAT	\$279.00	<input type="checkbox"/>	JZFX45C	E0956	LAT ZIP FIXED 4X5 CURVE	\$290.00

#### SWING-AWAY LATERAL THORACIC SUPPORT

*Includes swing-away mounting hardware and all laterals are sold in pairs.*

<input type="checkbox"/>	<b>JZSA34F</b>		<b>LAT 3X4 FLAT W/ S/A MOUNT</b>	<b>\$865.00</b>	<input type="checkbox"/>	<b>JZSA34CO</b>		<b>LAT 3X4 CRV 1" OFF W/ S/A MNT</b>	<b>\$876.00</b>
	JZ34F	E0956	LAT ZIP 3X4 FLAT	\$279.00		JZ34CO	E0956	LAT 3X4 CURVE W/ 1" OFFSET	\$290.00
	JZSAMNT	E1028	LATERAL SWING AWAY MOUNT	\$586.00		JZSAMNT	E1028	LATERAL SWING AWAY MOUNT	\$586.00
<input type="checkbox"/>	<b>JZSA45F</b>		<b>LAT 4X5 FLAT W/ S/A MOUNT</b>	<b>\$865.00</b>	<input type="checkbox"/>	<b>JZSA45CO</b>		<b>LAT 4X5 CRV 1" OFF W/ S/A MNT</b>	<b>\$876.00</b>
	JZ45F	E0956	LAT ZIP 4X5 FLAT	\$279.00		JZ45CO	E0956	LAT 4X5 CURVE W/ 1IN OFFSET	\$290.00
	JZSAMNT	E1028	LATERAL SWING AWAY MOUNT	\$586.00		JZSAMNT	E1028	LATERAL SWING AWAY MOUNT	\$586.00
<input type="checkbox"/>	<b>JZSA34C</b>		<b>LAT 3X4 CURVE W/ S/A MOUNT</b>	<b>\$876.00</b>	<input type="checkbox"/>	<b>JZSA34FOA</b>		<b>LAT 3X4 FLAT ADJ 1" OFF W/ S/A</b>	<b>\$871.00</b>
	JZ34C	E0956	LAT ZIP 3X4 CURVE	\$290.00		JZ34FOA	E0956	LAT 3X4 FLAT W/ ADJ 1" OFFSET	\$285.00
	JZSAMNT	E1028	LATERAL SWING AWAY MOUNT	\$586.00		JZSAMNT	E1028	LATERAL SWING AWAY MOUNT	\$586.00
<input type="checkbox"/>	<b>JZSA45C</b>		<b>LAT 4X5 CURVE W/ S/A MOUNT</b>	<b>\$876.00</b>	<input type="checkbox"/>	<b>JZSA45FOA</b>		<b>LAT 4X5 FLAT ADJ 1" OFF W/ S/A</b>	<b>\$871.00</b>
	JZ45C	E0956	LAT ZIP 4X5 CURVE	\$290.00		JZ45FOA	E0956	LAT 4X5 FLAT W/ ADJ 1" OFFSET	\$285.00
	JZSAMNT	E1028	LATERAL SWING AWAY MOUNT	\$586.00		JZSAMNT	E1028	LATERAL SWING AWAY MOUNT	\$586.00
<input type="checkbox"/>	<b>JZSA34FO</b>		<b>LAT 3X4 FLT 1" OFF W/ S/A MNT</b>	<b>\$865.00</b>	<input type="checkbox"/>	<b>JZSA34COA</b>		<b>LAT 3X4 CRV ADJ 1" OFF W/ S/A</b>	<b>\$882.00</b>
	JZ34FO	E0956	LAT ZIP 3X4 FLAT W/ 1" OFFSET	\$279.00		JZ34COA	E0956	LAT 3X4 CRV W/ ADJ 1" OFFSET	\$296.00
	JZSAMNT	E1028	LATERAL SWING AWAY MOUNT	\$586.00		JZSAMNT	E1028	LATERAL SWING AWAY MOUNT	\$586.00
<input type="checkbox"/>	<b>JZSA45FO</b>		<b>LAT 4X5 FLT 1" OFF W/ S/A MNT</b>	<b>\$865.00</b>	<input type="checkbox"/>	<b>JZSA45COA</b>		<b>LAT 4X5 CRV ADJ 1" OFF W/ S/A</b>	<b>\$882.00</b>
	JZ45FO	E0956	LAT ZIP 4X5 FLAT W/ 1" OFFSET	\$279.00		JZ45COA	E0956	LAT 4X5 CRV W/ ADJ 1" OFFSET	\$296.00
	JZSAMNT	E1028	LATERAL SWING AWAY MOUNT	\$586.00		JZSAMNT	E1028	LATERAL SWING AWAY MOUNT	\$586.00

#### LATERAL MEASURING GUIDE (Fixed and Swing Away)

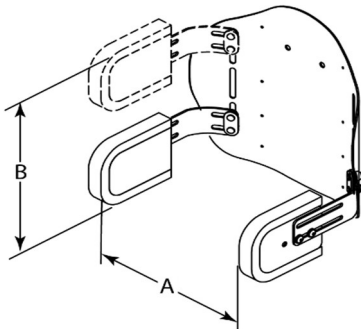

DIM		Description	Back Width			
			8" Wide	10" Wide	12" Wide	14" Wide
A	Lateral Adjustment Range (Min Spacing - Max Spacing)		3.8" - 4.8"	5.1" - 6.1"	6.8" - 7.8"	8.4" - 9.4"
B	Lateral Height Range (Measured from bottom edge of shell to top of lateral)	6" Tall Back	Not Available			
		8" Tall Back	7"			
		10" Tall Back	9"			
		12" Tall Back	10"			

### HEADRESTS

<input type="checkbox"/>	<b>JZHED6</b>		<b>Headrest w/ Pad - 6" Plush</b>	<b>\$364.00</b>
	JPLSH06	E0955	Pad - 6" Plush	\$182.00
	JZIPBHH	E1028	Onyx post w/ Axys Hardware	\$182.00
<input type="checkbox"/>	<b>JZHED8</b>		<b>Headrest w/ Pad - 8" Plush</b>	<b>\$364.00</b>
	JPLSH08	E0955	Pad - 8" Plush	\$182.00
	JZIPBHH	E1028	Onyx post w/ Axys Hardware	\$182.00
<input type="checkbox"/>	<b>JZHEDCINF</b>		<b>Headrest w/ Pad - 6" Contoured</b>	<b>\$344.00</b>
	JCNTR06	E0955	Pad - 6" Contoured Cradle	\$162.00
	JZIPBHH	E1028	Onyx post w/ Axys Hardware	\$182.00
<input type="checkbox"/>	<b>JZHEDCS</b>		<b>Headrest w/ Pad - 8" Contoured</b>	<b>\$344.00</b>
	JCNTR08	E0955	Pad - 8" Contoured Cradle	\$162.00
	JZIPBHH	E1028	Onyx post w/ Axys Hardware	\$182.00

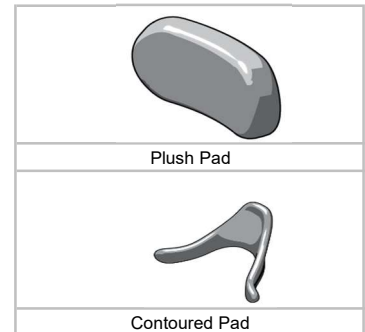
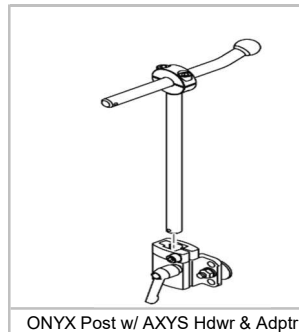







### VANITY FLAP

*Vanity flaps are NOT INCLUDED as a standard option with the JAY ZIP Back.*

<input type="checkbox"/>	VF08	K0108	8" to 9" Wide	\$50.00	<input type="checkbox"/>	VF12	K0108	12" to 13" Wide	\$50.00
<input type="checkbox"/>	VF10	K0108	10" to 11" Wide	\$50.00	<input type="checkbox"/>	VF14	K0108	14" to 15" Wide	\$50.00

**SPINE ALIGN POSITIONING COMPONENTS**

<input type="checkbox"/>	J3SPNCR	K0108	Curved Shim	\$27.00	<input type="checkbox"/>	J3SPNBL	K0108	Large Bean Bag	\$33.00
<input type="checkbox"/>	J3SPNBS	K0108	Small Bean Bag	\$30.00	<input type="checkbox"/>	J3SPNLS	K0108	Lateral Shim	\$53.00
<input type="checkbox"/>	J3SPNFL	K0108	Flat Shim	\$27.00	<input type="checkbox"/>	J3SPNLP	K0108	Posterior/Lateral Pelvic	\$53.00

						
	<b>Curved Shim</b>	<b>Flat</b>	<b>Lateral Shim</b>	<b>Sm Bean Bag</b>	<b>Lg Bean Bag</b>	<b>Post/Lat Pelvic</b>
<b>W</b>	10"	10"	2.4"	6"	10"	5.3"
<b>H</b>	4"	4"	4.3"	4.5"	3.2"	3.6"
<b>D</b>	0.5"	0.3"	0.5"	0.75"	0.75"	0.75"

**CHEST STRAPS & HARNESSSES**

*Chest Straps & Harnesses include guide brackets and hardware.*

<input type="checkbox"/>	JZ9407	E0960	Center Opening w/ Buckle (EI)	\$179.00	<input type="checkbox"/>	JZ9107	E0960	Contoured - Dynamic Pull Down (EI)	\$179.00
<input type="checkbox"/>	JZ9400	E0960	Center Opening w/ Buckle (XS)	\$179.00	<input type="checkbox"/>	JZ9100	E0960	Contoured - Dynamic Pull Down (XS)	\$179.00
<input type="checkbox"/>	JZ9401	E0960	Center Opening w/ Buckle (S)	\$179.00	<input type="checkbox"/>	JZ9101	E0960	Contoured - Dynamic Pull Down (S)	\$179.00
<input type="checkbox"/>	JZ9402	E0960	Center Opening w/ Buckle (M)	\$179.00	<input type="checkbox"/>	JZ9102	E0960	Contoured - Dynamic Pull Down (M)	\$179.00
<input type="checkbox"/>	JZ8107	E0960	Classic - Dynamic Pull Down (EI)	\$179.00	<input type="checkbox"/>	JZ9300	E0960	Contoured - Strctrd Pull Down (XS)	\$179.00
<input type="checkbox"/>	JZ8100	E0960	Classic - Dynamic Pull Down (XS)	\$179.00	<input type="checkbox"/>	JZ9301	E0960	Contoured - Strctrd Pull Down (S)	\$179.00
<input type="checkbox"/>	JZ8101	E0960	Classic - Dynamic Pull Down (S)	\$179.00	<input type="checkbox"/>	JZ9302	E0960	Contoured - Strctrd Pull Down (M)	\$179.00
<input type="checkbox"/>	JZ8102	E0960	Classic - Dynamic Pull Down (M)	\$179.00	<input type="checkbox"/>	JZ4050	E0960	Padded Anterior Trunk Straps (XS)	\$168.00
<input type="checkbox"/>	JZ8300	E0960	Classic - Structured Pull Down (XS)	\$179.00	<input type="checkbox"/>	JZ4000	E0960	Padded Anterior Trunk Straps (S)	\$168.00
<input type="checkbox"/>	JZ8301	E0960	Classic - Structured Pull Down (S)	\$179.00	<input type="checkbox"/>	JZ4100	E0960	Padded Anterior Trunk Straps (M)	\$168.00
<input type="checkbox"/>	JZ8302	E0960	Classic - Structured Pull Down (M)	\$179.00					

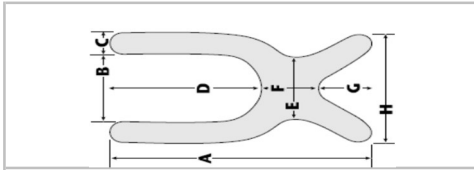
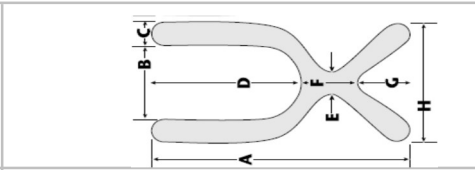
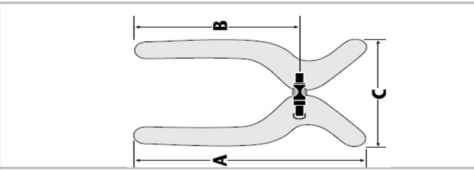
																																																																																																																
Classic Style	Contour Style	Center-Opening with Buckle																																																																																																														
<table border="1"> <tr><th></th><th>A</th><th>B</th><th>C</th><th>D</th><th>E</th><th>F</th><th>G</th><th>H</th></tr> <tr><td>EI</td><td>9.8"</td><td>3"</td><td>2"</td><td>5.3"</td><td>3"</td><td>3"</td><td>1"</td><td>6.5"</td></tr> <tr><td>XS</td><td>12.5"</td><td>3.5"</td><td>2"</td><td>7.5"</td><td>3.5"</td><td>3"</td><td>2"</td><td>7.5"</td></tr> <tr><td>S</td><td>15"</td><td>4.5"</td><td>2"</td><td>9"</td><td>4"</td><td>4"</td><td>2"</td><td>8.5"</td></tr> <tr><td>M</td><td>19"</td><td>5.5"</td><td>2"</td><td>11"</td><td>5"</td><td>5"</td><td>3"</td><td>9.5"</td></tr> </table>		A	B	C	D	E	F	G	H	EI	9.8"	3"	2"	5.3"	3"	3"	1"	6.5"	XS	12.5"	3.5"	2"	7.5"	3.5"	3"	2"	7.5"	S	15"	4.5"	2"	9"	4"	4"	2"	8.5"	M	19"	5.5"	2"	11"	5"	5"	3"	9.5"	<table border="1"> <tr><th></th><th>A</th><th>B</th><th>C</th><th>D</th><th>E</th><th>F</th><th>G</th><th>H</th></tr> <tr><td>EI</td><td>9.8"</td><td>3"</td><td>1.8"</td><td>5.3"</td><td>1"</td><td>3.5"</td><td>1.5"</td><td>6.5"</td></tr> <tr><td>XS</td><td>12.5"</td><td>3.5"</td><td>2"</td><td>7.5"</td><td>1"</td><td>3.5"</td><td>1.5"</td><td>7.5"</td></tr> <tr><td>S</td><td>15"</td><td>4.5"</td><td>2"</td><td>9"</td><td>1"</td><td>4"</td><td>2"</td><td>8.5"</td></tr> <tr><td>M</td><td>18.5"</td><td>5.5"</td><td>2"</td><td>11"</td><td>1"</td><td>5"</td><td>2.5"</td><td>9.5"</td></tr> </table>		A	B	C	D	E	F	G	H	EI	9.8"	3"	1.8"	5.3"	1"	3.5"	1.5"	6.5"	XS	12.5"	3.5"	2"	7.5"	1"	3.5"	1.5"	7.5"	S	15"	4.5"	2"	9"	1"	4"	2"	8.5"	M	18.5"	5.5"	2"	11"	1"	5"	2.5"	9.5"	<table border="1"> <tr><th></th><th>A</th><th>B</th><th>C</th></tr> <tr><td>EI</td><td>9.8"</td><td>7"</td><td>5"</td></tr> <tr><td>XS</td><td>11"</td><td>8"</td><td>5.8"</td></tr> <tr><td>S</td><td>12.3"</td><td>9"</td><td>6.5"</td></tr> <tr><td>M</td><td>14.3"</td><td>11"</td><td>9.8"</td></tr> </table>		A	B	C	EI	9.8"	7"	5"	XS	11"	8"	5.8"	S	12.3"	9"	6.5"	M	14.3"	11"	9.8"
	A	B	C	D	E	F	G	H																																																																																																								
EI	9.8"	3"	2"	5.3"	3"	3"	1"	6.5"																																																																																																								
XS	12.5"	3.5"	2"	7.5"	3.5"	3"	2"	7.5"																																																																																																								
S	15"	4.5"	2"	9"	4"	4"	2"	8.5"																																																																																																								
M	19"	5.5"	2"	11"	5"	5"	3"	9.5"																																																																																																								
	A	B	C	D	E	F	G	H																																																																																																								
EI	9.8"	3"	1.8"	5.3"	1"	3.5"	1.5"	6.5"																																																																																																								
XS	12.5"	3.5"	2"	7.5"	1"	3.5"	1.5"	7.5"																																																																																																								
S	15"	4.5"	2"	9"	1"	4"	2"	8.5"																																																																																																								
M	18.5"	5.5"	2"	11"	1"	5"	2.5"	9.5"																																																																																																								
	A	B	C																																																																																																													
EI	9.8"	7"	5"																																																																																																													
XS	11"	8"	5.8"																																																																																																													
S	12.3"	9"	6.5"																																																																																																													
M	14.3"	11"	9.8"																																																																																																													

**JAY YOUR WAY MODIFICATIONS**

*Note: To order options offered via JAY Your Way add an "M" to the front of the part number and follow the prompts.*

*For additional modifications visit [www.sunrisemedical.com](http://www.sunrisemedical.com) to view even more!*

COVER COLOR OPTIONS - Rear Center Flap			
<input type="checkbox"/>	COCPI	Pink Semi Stretch Cover	NC
<input type="checkbox"/>	COCB	Blue Semi Stretch Cover	NC
<input type="checkbox"/>	COCPU	Purple Cover	NC
<input type="checkbox"/>	COCR	Red Cover	NC
<input type="checkbox"/>	COCB	Toxic Green Cover	NC

COLOR BACK SHELLS			
<i>Paint your Zip back shell to match any of the Zippie or Quickie Frame Colors!</i>			
<input type="checkbox"/>	XXCBS	Zippie/Quickie Back Shell Paint	NC
Write Desired Back Shell Color Here:			

EMBROIDERY			
<input type="checkbox"/>	EMBROIDERY	K0108	Embroidery (32 Character Max) \$24.00
Location: <input type="checkbox"/> Front			
Font: <input type="checkbox"/> Block <input type="checkbox"/> Script			

SPINAL FLUID PAD			
<input type="checkbox"/>	SFPS	Small Spinal Fluid Pad	\$56.00
<input type="checkbox"/>	SFPM	Medium Spinal Fluid Pad	\$56.00

**Don't see the option you want? NO PROBLEM!**

**Write your request below and we can evaluate it and provide a quote.**

Notes:

Embroidery Text:



**Sunrise Medical (US) LLC**  
2842 Business Park Ave. · Fresno, CA 93727 · USA