

Mark For:

Submitting for:

Quote Order

Date: _____
 Dealer Acct #: _____
 Dealer: _____
 Dealer Contact: _____
 Dealer Address: _____
 Dealer City: _____ ST: _____ ZIP: _____
 Dealer Phone: () Fax: ()
 Confirmation Email: _____
 Confirm Via: Fax Email

PO#: _____
 ADDITIONAL SHIPPING INFORMATION
 Ship To: _____
 Attention: _____
 Address: _____
 Address: _____
 Ship To City: _____ ST: _____ ZIP: _____
 Ship To Phone: () Fax: ()

The **HCPCS CODES** herein are based on PDAC verification or interpretation of Medicare definitions and guidelines. Non-Medicare payers may accept alternative **HCPCS CODES**, including misc. codes to ensure access for their enrollees. The use of **HCPCS CODES** does not ensure coverage or payment.

Head Positioning - Use HCPCS Code E0955

Whitmyer headrests come unassembled. Please add item WHITASSY001 if the dealer would like parts assembled. This is a no charge option.
 Note: For cover selection, **L** = Lycra and **V** = Dartex Reversed



SINGLE SUB- OCCIPITAL	10" Pad Lrg OCC
	6" Pad Lrg OCC
	6" Pad Sml OCC
	5" Pad Sml OCC

<input type="checkbox"/>	AXYS-SS10L	\$418	<input type="checkbox"/>	ONYX-SS10L	\$418	<input type="checkbox"/>	LINX-SS10L	\$446	<input type="checkbox"/>	LINX2-SS10L	\$486
<input type="checkbox"/>	AXYS-SS10V	\$418	<input type="checkbox"/>	ONYX-SS10V	\$418	<input type="checkbox"/>	LINX-SS10V	\$446	<input type="checkbox"/>	LINX2-SS10V	\$486
<input type="checkbox"/>	AXYS-SS8L	\$389	<input type="checkbox"/>	ONYX-SS8L	\$389	<input type="checkbox"/>	LINX-SS8L	\$424	<input type="checkbox"/>	LINX2-SS8L	\$463
<input type="checkbox"/>	AXYS-SS8V	\$389	<input type="checkbox"/>	ONYX-SS8V	\$389	<input type="checkbox"/>	LINX-SS8V	\$424	<input type="checkbox"/>	LINX2-SS8V	\$463
<input type="checkbox"/>	AXYS-SS4L	\$355	<input type="checkbox"/>	ONYX-SS4L	\$355	<input type="checkbox"/>	LINX-SS4L	\$389	<input type="checkbox"/>	LINX2-SS4L	\$429
<input type="checkbox"/>	AXYS-SS4V	\$355	<input type="checkbox"/>	ONYX-SS4V	\$355	<input type="checkbox"/>	LINX-SS4V	\$389	<input type="checkbox"/>	LINX2-SS4V	\$429
<input type="checkbox"/>	AXYS-SS3L	\$355	<input type="checkbox"/>	ONYX-SS3L	\$355	<input type="checkbox"/>	LINX-SS3L	\$389	<input type="checkbox"/>	LINX2-SS3L	\$429
<input type="checkbox"/>	AXYS-SS3V	\$355	<input type="checkbox"/>	ONYX-SS3V	\$355	<input type="checkbox"/>	LINX-SS3V	\$389	<input type="checkbox"/>	LINX2-SS3V	\$429

ADULT DUAL SUB- OCCIPITAL	8" Pad Size 1 OCC
	10" Pad Size 1 OCC
	6" Pad Size 2 OCC
	6" Pad Size 1 OCC

<input type="checkbox"/>	AXYS-8L	\$491	<input type="checkbox"/>	ONYX-8L	\$537	<input type="checkbox"/>	LINX-8L	\$508	<input type="checkbox"/>	LINX2-8L	\$548
<input type="checkbox"/>	AXYS-8V	\$491	<input type="checkbox"/>	ONYX-8V	\$537	<input type="checkbox"/>	LINX-8V	\$508	<input type="checkbox"/>	LINX2-8V	\$548
<input type="checkbox"/>	AXYS-5L	\$560	<input type="checkbox"/>	ONYX-5L	\$560	<input type="checkbox"/>	LINX-5L	\$530	<input type="checkbox"/>	LINX2-5L	\$570
<input type="checkbox"/>	AXYS-5V	\$560	<input type="checkbox"/>	ONYX-5V	\$560	<input type="checkbox"/>	LINX-5V	\$530	<input type="checkbox"/>	LINX2-5V	\$570
<input type="checkbox"/>	AXYS-2L	\$486	<input type="checkbox"/>	ONYX-2L	\$486	<input type="checkbox"/>	LINX-2L	\$468	<input type="checkbox"/>	LINX2-2L	\$508
<input type="checkbox"/>	AXYS-2V	\$486	<input type="checkbox"/>	ONYX-2V	\$486	<input type="checkbox"/>	LINX-2V	\$468	<input type="checkbox"/>	LINX2-2V	\$508
<input type="checkbox"/>	AXYS-1L	\$486	<input type="checkbox"/>	ONYX-1L	\$486	<input type="checkbox"/>	LINX-1L	\$468	<input type="checkbox"/>	LINX2-1L	\$508
<input type="checkbox"/>	AXYS-1V	\$486	<input type="checkbox"/>	ONYX-1V	\$486	<input type="checkbox"/>	LINX-1V	\$468	<input type="checkbox"/>	LINX2-1V	\$508

PEDIATRIC DUAL SUB- OCCIPITAL	8" Pad Size 3 OCC
	5" Pad Size 4 OCC
	6" Pad Size 3 OCC
	5" Pad Size 3 OCC



<input type="checkbox"/>	AXYS-7L	\$491	<input type="checkbox"/>	ONYX-7L	\$486	<input type="checkbox"/>	LINX-7L	\$508	<input type="checkbox"/>	LINX2-7L	\$548
<input type="checkbox"/>	AXYS-7V	\$491	<input type="checkbox"/>	ONYX-7V	\$486	<input type="checkbox"/>	LINX-7V	\$508	<input type="checkbox"/>	LINX2-7V	\$548
<input type="checkbox"/>	AXYS-6L	\$486	<input type="checkbox"/>	ONYX-6L	\$486	<input type="checkbox"/>	LINX-6L	\$468	<input type="checkbox"/>	LINX2-6L	\$508
<input type="checkbox"/>	AXYS-6V	\$486	<input type="checkbox"/>	ONYX-6V	\$486	<input type="checkbox"/>	LINX-6V	\$468	<input type="checkbox"/>	LINX2-6V	\$508
<input type="checkbox"/>	AXYS-4L	\$486	<input type="checkbox"/>	ONYX-4L	\$486	<input type="checkbox"/>	LINX-4L	\$468	<input type="checkbox"/>	LINX2-4L	\$508
<input type="checkbox"/>	AXYS-4V	\$486	<input type="checkbox"/>	ONYX-4V	\$486	<input type="checkbox"/>	LINX-4V	\$468	<input type="checkbox"/>	LINX2-4V	\$508
<input type="checkbox"/>	AXYS-3L	\$486	<input type="checkbox"/>	ONYX-3L	\$486	<input type="checkbox"/>	LINX-3L	\$468	<input type="checkbox"/>	LINX2-3L	\$508
<input type="checkbox"/>	AXYS-3V	\$486	<input type="checkbox"/>	ONYX-3V	\$486	<input type="checkbox"/>	LINX-3V	\$468	<input type="checkbox"/>	LINX2-3V	\$508

CUDDLES INFANT

<input type="checkbox"/>	AXYS-INFT	\$373	<input type="checkbox"/>	ONYX-INFTL	\$373	N/A				
--------------------------	-----------	-------	--------------------------	------------	-------	------------	--	--	--	--

Head Positioning - Use HCPCS Code E0955





Whitmyer headrests come unassembled. Please add item WHITASSY001 if the dealer would like parts assembled. This is a no charge option.





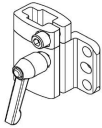

		<input type="checkbox"/> Receiver must be selected at bottom of page		<input type="checkbox"/> Adult - 15" <input type="checkbox"/> Peds - 11" <input type="checkbox"/> EI - 10"		<input type="checkbox"/> Adult - 15" <input type="checkbox"/> Peds - 11" <input type="checkbox"/> EI - 10"
PAD	PRO		COBRA		COBRA-FB	

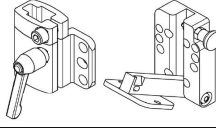
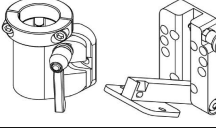
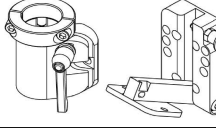
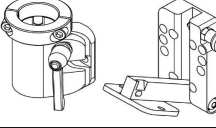
SINGLE SUB-OCCIPITAL	10" Pad Lrg OCC	<input type="checkbox"/> PRO-SS10L \$486	<input type="checkbox"/> COBRA-SS10L \$712	<input type="checkbox"/> FB-COBRA-SS10L \$825
		<input type="checkbox"/> PRO-SS10V \$486	<input type="checkbox"/> COBRA-SS10V \$712	<input type="checkbox"/> FB-COBRA-SS10V \$825
	6" Pad Lrg OCC	<input type="checkbox"/> PRO-SS8L \$473	<input type="checkbox"/> COBRA-SS8L \$700	<input type="checkbox"/> FB-COBRA-SS8L \$813
		<input type="checkbox"/> PRO-SS8V \$473	<input type="checkbox"/> COBRA-SS8V \$700	<input type="checkbox"/> FB-COBRA-SS8V \$813
	6" Pad Sml OCC	<input type="checkbox"/> PRO-SS4L \$406	<input type="checkbox"/> COBRA-SS4L \$631	<input type="checkbox"/> FB-COBRA-SS4L \$745
	<input type="checkbox"/> PRO-SS4V \$406	<input type="checkbox"/> COBRA-SS4V \$631	<input type="checkbox"/> FB-COBRA-SS4V \$745	
	<input type="checkbox"/> PRO-SS3L \$406	<input type="checkbox"/> COBRA-SS3L \$631	<input type="checkbox"/> FB-COBRA-SS3L \$745	
	<input type="checkbox"/> PRO-SS3V \$406	<input type="checkbox"/> COBRA-SS3V \$631	<input type="checkbox"/> FB-COBRA-SS3V \$745	
ADULT DUAL SUB-OCCIPITAL	8" Pad Size 1 OCC	<input type="checkbox"/> PRO-8L \$582	<input type="checkbox"/> COBRA-8L \$807	<input type="checkbox"/> FB-COBRA-8L \$919
		<input type="checkbox"/> PRO-8V \$582	<input type="checkbox"/> COBRA-8V \$807	<input type="checkbox"/> FB-COBRA-8V \$919
	10" Pad Size 1 OCC	<input type="checkbox"/> PRO-5L \$582	<input type="checkbox"/> COBRA-5L \$807	<input type="checkbox"/> FB-COBRA-5L \$919
		<input type="checkbox"/> PRO-5V \$582	<input type="checkbox"/> COBRA-5V \$807	<input type="checkbox"/> FB-COBRA-5V \$919
	6" Pad Size 2 OCC	<input type="checkbox"/> PRO-2L \$530	<input type="checkbox"/> COBRA-2L \$756	<input type="checkbox"/> FB-COBRA-2L \$869
		<input type="checkbox"/> PRO-2V \$530	<input type="checkbox"/> COBRA-2V \$756	<input type="checkbox"/> FB-COBRA-2V \$869
	6" Pad Size 1 OCC	<input type="checkbox"/> PRO-1L \$530	<input type="checkbox"/> COBRA-1L \$756	<input type="checkbox"/> FB-COBRA-1L \$869
	<input type="checkbox"/> PRO-1V \$530	<input type="checkbox"/> COBRA-1V \$756	<input type="checkbox"/> FB-COBRA-1V \$869	
PEDIATRIC DUAL SUB-OCCIPITAL	8" Pad Size 3 OCC	<input type="checkbox"/> PRO-7L \$575	<input type="checkbox"/> COBRA-7L \$802	<input type="checkbox"/> FB-COBRA-7L \$914
		<input type="checkbox"/> PRO-7V \$575	<input type="checkbox"/> COBRA-7V \$802	<input type="checkbox"/> FB-COBRA-7V \$914
	5" Pad Size 4 OCC	<input type="checkbox"/> PRO-6L \$520	<input type="checkbox"/> COBRA-6L \$745	<input type="checkbox"/> FB-COBRA-6L \$858
		<input type="checkbox"/> PRO-6V \$520	<input type="checkbox"/> COBRA-6V \$745	<input type="checkbox"/> FB-COBRA-6V \$858
	6" Pad Size 3 OCC	<input type="checkbox"/> PRO-4L \$520	<input type="checkbox"/> COBRA-4L \$745	<input type="checkbox"/> FB-COBRA-4L \$858
		<input type="checkbox"/> PRO-4V \$520	<input type="checkbox"/> COBRA-4V \$745	<input type="checkbox"/> FB-COBRA-4V \$858
	5" Pad Size 3 OCC	<input type="checkbox"/> PRO-3L \$520	<input type="checkbox"/> COBRA-3L \$745	<input type="checkbox"/> FB-COBRA-3L \$858
	<input type="checkbox"/> PRO-3V \$520	<input type="checkbox"/> COBRA-3V \$745	<input type="checkbox"/> FB-COBRA-3V \$858	

Mounting Brackets - Use HCPCS Code E1028

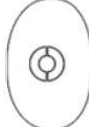
Head Support System Mounting Brackets must be ordered separately, except for COBRA



	AXYS	ONYX	LINX & LINX²	PRO	COBRA mounting system includes detachable mounting bracket
REMOVABLE MOUNTING BRACKET <small>(PART SOLD SEPARATELY FROM POST & PAD)</small>					
Detachable	<input type="checkbox"/> M2500 \$119	<input type="checkbox"/> M2100-WB \$97	<input type="checkbox"/> M2300 \$186	<input type="checkbox"/> M2200-WB \$209	
REMOVABLE & SWING-AWAY MNT BRACKET <small>(PART SOLD SEPARATELY FROM POST & PAD)</small>					
Swing-Away	<input type="checkbox"/> M5500 \$226	<input type="checkbox"/> M5100 \$209	<input type="checkbox"/> M5300 \$299	<input type="checkbox"/> M5200 \$321	

Lateral Facial Supports								
Note: Cover Selection - Add L = Lycra or V = Dartex Reversed (Example: LFC-PLL)								
								
2"	2.25" x 5"	2.25" x 7"	4" x 6"	2" x 6"	1.75" x 5"	1.25" x 4"		
SPOT	STANDARD	LONG	OVAL	LARGE-C	MED-C	SMALL-C	FSO-B	

Unilateral	<input type="checkbox"/>	LFC10L \$209 LM115 \$90	<input type="checkbox"/>	LFC15L \$209 LM115 \$90	<input type="checkbox"/>	LFC20L \$209 LM115 \$90	<input type="checkbox"/>	LFC25L \$209 LM115 \$90	<input type="checkbox"/>	LFC30L \$209 LM115 \$90	<input type="checkbox"/>	LFC35L \$209 LM115 \$90	<input type="checkbox"/>	LFC40L \$209 LM115 \$90	<input type="checkbox"/>	LFC80 \$242 LM115 \$90
	<input type="checkbox"/>	LFC10V \$209 LM115 \$90	<input type="checkbox"/>	LFC15V \$209 LM115 \$90	<input type="checkbox"/>	LFC20V \$209 LM115 \$90	<input type="checkbox"/>	LFC25V \$209 LM115 \$90	<input type="checkbox"/>	LFC30V \$209 LM115 \$90	<input type="checkbox"/>	LFC35V \$209 LM115 \$90	<input type="checkbox"/>	LFC40V \$209 LM115 \$90		

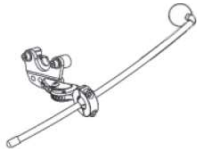
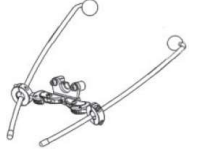

Bilateral	<input type="checkbox"/>	LFC10L \$209 LM115 \$90	<input type="checkbox"/>	LFC15L \$209 LM115 \$90	<input type="checkbox"/>	LFC20L \$209 LM115 \$90	<input type="checkbox"/>	LFC25L \$209 LM115 \$90	<input type="checkbox"/>	LFC30L \$209 LM115 \$90	<input type="checkbox"/>	LFC35L \$209 LM115 \$90	<input type="checkbox"/>	LFC40L \$209 LM115 \$90	<input type="checkbox"/>	LFC80 \$242 LM115 \$90	
	<input type="checkbox"/>	LFC10V \$209 LM115 \$90	<input type="checkbox"/>	LFC15V \$209 LM115 \$90	<input type="checkbox"/>	LFC20V \$209 LM115 \$90	<input type="checkbox"/>	LFC25V \$209 LM115 \$90	<input type="checkbox"/>	LFC30V \$209 LM115 \$90	<input type="checkbox"/>	LFC35V \$209 LM115 \$90	<input type="checkbox"/>	LFC40V \$209 LM115 \$90			
	<input type="checkbox"/>	LFC10L \$209 LM115 \$90	<input type="checkbox"/>	LFC15L \$209 LM115 \$90	<input type="checkbox"/>	LFC20L \$209 LM115 \$90	<input type="checkbox"/>	LFC25L \$209 LM115 \$90	<input type="checkbox"/>	LFC30L \$209 LM115 \$90	<input type="checkbox"/>	LFC35L \$209 LM115 \$90	<input type="checkbox"/>	LFC40L \$209 LM115 \$90			
	<input type="checkbox"/>	LFC10V \$209 LM115 \$90	<input type="checkbox"/>	LFC15V \$209 LM115 \$90	<input type="checkbox"/>	LFC20V \$209 LM115 \$90	<input type="checkbox"/>	LFC25V \$209 LM115 \$90	<input type="checkbox"/>	LFC30V \$209 LM115 \$90	<input type="checkbox"/>	LFC35V \$209 LM115 \$90	<input type="checkbox"/>	LFC40V \$209 LM115 \$90			

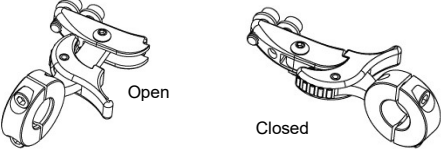
Pad Only*	<input type="checkbox"/>	PL10L \$80	<input type="checkbox"/>	PL15L \$113	<input type="checkbox"/>	PL20L \$113	<input type="checkbox"/>	P600L \$113	<input type="checkbox"/>	PL30L \$113	<input type="checkbox"/>	PL35L \$113	<input type="checkbox"/>	PL40L \$102	N/A
	<input type="checkbox"/>	PL10V \$80	<input type="checkbox"/>	PL15V \$113	<input type="checkbox"/>	PL20V \$113	<input type="checkbox"/>	P600V \$113	<input type="checkbox"/>	PL30V \$113	<input type="checkbox"/>	PL35V \$113	<input type="checkbox"/>	PL40V \$102	

Lateral Facial Supports				
MOUNTING HARDWARE				
	Unilateral	Bilateral	Infinity Mount	Swing-Away Mount LM115

LATERAL FACIAL SUPPORT PARTS
 *Note: If ordering an additional Lateral Facial Support, select both a Lateral Facial Support Pad Only from above and an Infinity Mount from below as well

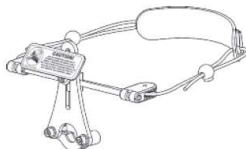
✓	Option #	Definition	Price
<input type="checkbox"/>	242161	Infinity Dual Mount Assembly*	\$220
<input type="checkbox"/>	LM1010	Lateral Facial Support*	\$142

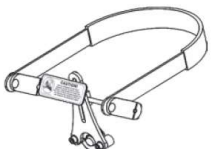
ANTERIOR HEAD SUPPORT									
									
DYNAMIC FOREHEAD STRAP	DFS²	STRAP CAP	STATIC FOREHEAD STRAP						
ADULT	<input type="checkbox"/>	DFS10 \$326	<input type="checkbox"/>	DFSQ10 \$395	<input type="checkbox"/>	CAP10 (black) \$451			
PEDS	<input type="checkbox"/>	DFS30 \$326	<input type="checkbox"/>	DFSQ30 \$395	<input type="checkbox"/>	CAP30-R (red) \$451	<input type="checkbox"/>	HU10 \$356	
					<input type="checkbox"/>	CAP30-B (blue) \$451			

MOUNTING OPTIONS

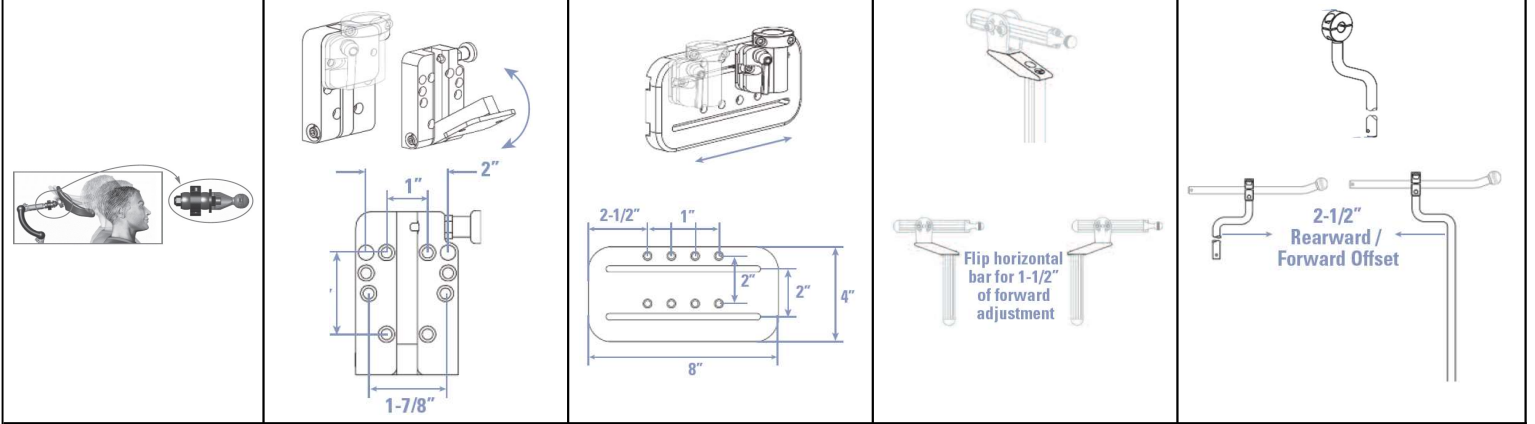

FLEX INTERFACE BRACKET	UNIVERSAL SWING-AWAY MOUNT	SLIDE MOUNT	PRO OFF-SET MOUNTING SYSTEM	ONYX REARWARD OFF-SET VERTICAL ROD
<input type="checkbox"/> M9450 (hard) \$209 <input type="checkbox"/> M9451 (soft) \$209	<input type="checkbox"/> M5000 \$113	<input type="checkbox"/> M7010 \$107	<input type="checkbox"/> PRC7070 \$184	<input type="checkbox"/> OX6030 \$68

TOOLS

Option #	Definition	Price
<input type="checkbox"/> BOLT LUBE	Bolt Lube	\$9.00
<input type="checkbox"/> T2500	Tool Kit	\$7.00

Pad Styles

SINGLE SUB-OCCIPITAL	 10" Pad Large OCC SS10 PAD = 10"w X 5"h SUB OCC = 9"w X 3"h	 6" Pad Large OCC SS8 PAD = 6"w X 4"h SUB OCC = 9"w X 3"h	 6" Pad Small OCC SS4 PAD = 6"w X 4"h SUB OCC = 8"w X 2"h	 5" Pad Small OCC SS3 PAD = 5"w X 2-1/4"h SUB OCC = 8"w X 2"h
	ADULT DUAL SUB-OCCIPITAL	 8" Pad Size 1 OCC 8 PAD = 8"w X 5"h SUB OCC = 8"w X 3"h	 10" Pad Size 1 OCC 5 PAD = 10"w X 5"h SUB OCC = 8"w X 3"h	 6" Pad Size 2 OCC 2 PAD = 6"w X 4"h SUB OCC = 4"w X 3"h
Pediatric DUAL SUB-OCCIPITAL		 8" Pad Size 3 OCC PAD = 8"w X 5"h SUB OCC = 7"w X 2.5"h	 5" Pad Size 4 OCC PAD = 5"w X 2-1/4"h SUB OCC = 4"w X 2.5"h	 6" Pad Size 3 OCC PAD = 6"w X 4"h SUB OCC = 7"w X 2.5"h
	CUDDLES INFANT	 INFT Pad Size 3 OCC PAD = 3.5"w X 1.5"h SUB OCC = 4"w X 1.75"h		



Sunrise Medical (US) LLC
2842 Business Park Ave. · Fresno, CA 93727 · USA

Customer Service: 800-333-4000 Fax: 800-300-7502 Email: orders@sunmed.com www.sunrisemedical.com
©2/2023 MK-129442 REV. H