

## ORDER FORM



To see QUICKIE Power Options  
or Accessories, scan here or visit:  
[https://www.sunrisemedical.com/  
power-wheelchair-options-accessories](https://www.sunrisemedical.com/power-wheelchair-options-accessories)



# Q500M with SEDEO® PRO™ and JAY® Syncra™ Seating

**EIPW30**

Customer		Ship To	
Account #		Name	
Date		Address	
PO#		City	
Buyer		State	Zip
Mark For		Phone	

## Client Measurements

a) Top of head to seat	in
b) Top of shoulder to seat	in
c) Underarm to seat	in
d) Elbow to seat	in
e) Top of leg to seat	in
f) Shoulder width	in
g) Chest width	in
i) Hip width	in
j) Actual sitting depth	in
m) Foot length	in
n) Knee to foot	in
o) Seat width	in

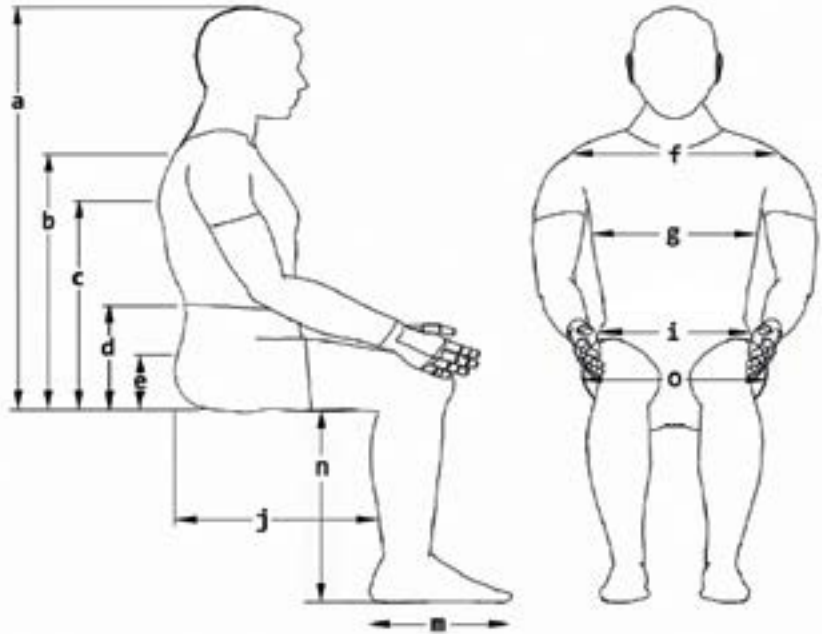

## Notes

## Chair Specifications



HCPC	K0848 / K0856 / K0861
Weights starting at: (with Batteries)	NPC: 300 lbs SPC: 324 lbs MPC: 338 lbs
Power Seating	50° of CG Tilt and Power Recline with 4" mechanical sheer reduction / 12" seat elevator
Seat Type	SEDEO® PRO™ / JAY® Syncra™
Seat Size Range	Width 16" to 22" Depth 14" to 22"
Seat-to-Floor Height Range	16.5" to 19"

## Mid-Wheel Drive Base Specifications

Drive Wheel Position	Mid-wheel drive
User Weight Capacity	300 lbs.
Base Size	Width 24", Length 33"
Minimum Turning Radius	18.5" (excludes footplates)
Drive Control	R-net PM 90A / VR-2 90A
Driving Range	Up to 13.5 miles
Drive Motors	4-pole 6 mph / 10 kph
Drive Wheels	13" w/flat-free inserts (black)
Casters	7" front / 7" rear (black)
Charger	8A Dual Mode (Compact)
Battery Size	Group 34 / Group 22
Color	8 shroud colors and 6 color accents
Ground Clearance	3"

BASE			
OPTION	HCPC	DESCRIPTION	RETAIL
Group 3 Standard Duty Mid Wheel Drive Base <i>End Item Number EIPW30 (PRO™ Seat)</i>			\$
300PC215	K0848	Quickie Q500 M NPC No Power Option for SEDEO® PRO™ Seat Included in Base Pricing : Q500 M Base, VR-2 90amp Electronics for No Power Seat Functions, Six-Wheel Suspension, 13" Drive Wheels with Dual Density Inserts, 7" Flat Free Casters, ISO Occupied Tie-Down Brackets and 8amp Charger. Max Speed = 6mph, Weight Capacity = 300lbs., STFH = 16.5".	\$8,374.00
300PC216	K0856	Quickie Q500 M SPC Single Power Option for SEDEO® PRO™ Seat Included in Base Pricing : Q500 M Base, VR-2 90amp Electronics for No Power Seat Functions, Six-Wheel Suspension, 13" Drive Wheels with Dual Density Inserts, 7" Flat Free Casters, ISO Occupied Tie-Down Brackets and 8amp Charger. Max Speed = 6mph, Weight Capacity = 300lbs., STFH = 16.5".	\$8,374.00
300PC217	K0861	Quickie Q500 M MPC Tilt/Recline for SEDEO® PRO™ Seat Included in Base Pricing: Q500 M Base, VR-2 90amp Electronics for No Power Seat Functions, Six-Wheel Suspension, 13" Drive Wheels with Dual Density Inserts, 7" Flat Free Casters, ISO Occupied Tie-Down Brackets and 8amp Charger. Max Speed = 6mph, Weight Capacity = 300lbs., STFH = 16.5".	\$8,374.00
User Weight			\$
300WG23	–	Up to 300 lbs.	NC
Motor Package			\$
300PF99	–	4-pole 10 kph / 6 mph <i>(Standard for Group 3 K0848, K0856, K0861)</i>	NC
Drive Wheels  P. 22			\$
300DW69	–	Drive Wheel, 13", Dual Density, Knobby, Black	NC
Caster Wheels  P. 22			\$
300CW59	–	Caster Wheels 7", Solid, Black	NC
Shroud Color			\$
300C119	–	Matte Black	NC
300C165	–	Candy Apple Red	NC
300C166	–	Candy Blue	NC
300C167	–	Candy Purple	NC
300C176	–	Green Apple	NC
300C178	–	Pearl Pink	NC
300C182	–	Silver	NC
300C170	–	American Flag	\$590.00
Color Accents			\$
<i>Note: Accent colors and shroud colors may not match.</i>			
300EZ20	–	Apple Green	NC
300EZ22	–	Black	NC
300EZ21	–	Blue	NC
300EZ23	–	Orange	NC
300EZ24	–	Red	NC
300EZ25	–	Silver	NC
300EZ19	–	White	NC

**BASE**

OPTION	HCPC	DESCRIPTION	RETAIL
<b>Service Decals</b>			<b>\$</b>
300D10	–	Army	NC
300D11	–	Air Force	NC
300D13	–	Marines	NC
300D14	–	Navy	NC
300D15	–	Purple Heart	NC
<b>ISO Transit Tie Downs</b>			<b>\$</b>
300T050	–	ISO Transit Package	NC
<b>LED Lights</b>  P. 22			<b>\$</b>
300LI04	–	LED Lights and Indicators	\$1,373.00
300LI08	–	LED Fender Lights	\$555.00
300LI09	–	LED Fender Lights <i>(Available with multi-power only)</i>	NC
300LI02	–	Omit LED Lights	NC
<b>Seat Heights</b>			<b>\$</b>
		<b>Seat Height</b> <i>Measured from front of seat pan to floor with 0° frame angle.</i>	
300HT103	–	16.5"	NC
300HT55	–	17"	NC
300HT104	–	17.5"	NC
300HT56	–	18"	NC
300HT105	–	18.5"	NC
300HT57	–	19" <i>(Only available with Tilt or Seat Elevator.)</i>	NC
<b>Batteries and Chargers</b>  P. 22			<b>\$</b>
<b>Group 34 Battery Options</b>			
300AG27	E2359	GP34 Flat Top Pair w/Straps MK Gel	\$1,075.00
300AG29	E2359	GP34 Flat Top Pair w/Straps Brightway AGM	\$812.00
<b>Group 22 Battery</b>			
300AG31	E2361	GP22 Flat Top Pair w/Straps	\$601.00
<b>Omit Batteries</b>			
300AG24	–	Battery Harnesses Only <i>(Omit Batteries)</i>	NC
<b>Chargers</b>			
300BJ30	–	10A Dual Mode (Compact)	\$108.00
300BJ19	–	8A Dual Mode (Compact)	NC

**POWERED SEATING**

OPTION	HCPC	DESCRIPTION	RETAIL
--------	------	-------------	--------

**Power Seating Options**  P. 22 \$
**Seat Elevator**

300PI07	E2300	Seat Elevator, Powered, 300 mm / 12"	\$3,717.00
300PI08	E2300	C-Me® Seat Elevator, Powered, 300 mm / 12" (C-Me speed up to 3 mph) (N/A with VR-2)	\$3,717.00

**Seat Tilt**

300PA48	E1002	Posterior 50° Tilt	\$8,292.00
---------	-------	--------------------	------------

**Seat Recline**

300PA37	E1004	150° Powered Recline w/ 4" Shear Reduction	\$8,292.00
---------	-------	--	------------

**Seat Tilt/Recline**

300PA41	E1007	Posterior 50° Tilt and 150° Recline Powered, w/ 4" Shear Reduction	\$13,440.00
---------	-------	--	-------------

**Power Recline Backrest Preset Home Angle**

300QK1	–	90°	NC
300QK2	–	95° (Default Position)	NC

**Pre Set Seat Frame Angle (No Power Seating Options, Increases Seat to Floor Height)** \$

300FA10	–	0° (Adds 0" to STFH)	NC
300FA3	–	3° (Adds 1" to STFH)	NC

**Backrest Frame Type** \$

300BF16	–	Tool Angle Adjustable Back, 90°-120°	NC
300BF14	E1225	User Adjustable Manual Semi-Recline Back, 90°-130°, Right (Adjustment Lever Mounted on Opposite Side of Joystick)	\$669.00
300BF15	E1225	User Adjustable Manual Semi-Recline Back, 90°-130°, Left (Adjustment Lever Mounted on Opposite Side of Joystick)	\$669.00

**Backrest Frame Option** \$

300BF13	–	Flip Down, Quick Release	\$144.00
---------	---	--------------------------	----------

**Back Cushion Type** \$

300BT134	–	SEDEO® Back Cushion (Choose Seating in Section A)	NC
300BT138	–	JAY® Syncra™ (Choose Seating in Section B)	NC
300BT135	–	JAY® J3® (Choose Seating in Section C)	NC
300BT137	–	SEDEO® PRO™ Aftermarket Back Adapter (Height Adjustable Round Tubes for Traditional Mounting)	\$515.00
300BT133	–	OMIT (For personalized Mounting. No Headrest Mount)	NC

**POWERED SEATING**

OPTION	HCPC	DESCRIPTION	RETAIL
--------	------	-------------	--------

**A - SEDEO® Backrest Dimensions**

\$

**Back Width**

300BN28	–	400mm / 16"	NC
300BN29	–	460mm / 18"	NC
300BN30	–	500mm / 20"	NC
300BN31	–	560mm / 22"	NC

**Back Shell Height**

			Tool Angle Adjust.	150° Recline	Installed Back Height	
300B255	–	460mm / 18"	22"-23"	23"-25"		NC
300B256	–	560mm / 22"	24"-27"	26"-29"		NC
300B257	–	660mm / 26"	28"-30"	30"		NC

**Installed Back Height - (From Pan to Top of Back)**

300JR32	–	22"	NC
300JR33	–	23"	NC
300JR34	–	24"	NC
300JR35	–	25"	NC
300JR36	–	26"	NC
300JR37	–	27"	NC
300JR38	–	28"	NC
300JR39	–	29"	NC
300JR40	–	30"	NC

**B - JAY® Syncra™ Seating****B - JAY® Syncra™ Back**  P. 21

\$

300JP14	E2620	JAY® Syncra™ Back 16-20" Wide with 3" Contour Depth	\$1,116.00
300JP15	E2621	JAY® Syncra™ Back 22" Wide with 3" Contour Depth	\$1,230.00

**B - JAY® Syncra™ Back Width**

\$

Back can be ordered a different width than seat pan. Armrest will be adjusted to back width ordered.

300JQ07	–	16" Wide (Adjustment range 16 to 17" Wide)*	NC
300JQ08	–	18" Wide (Adjustment range 18 to 19" Wide)*	NC
300JQ09	–	20" Wide (Adjustment range 20 to 21" Wide)*	NC
300JQ10	–	22" Wide (Adjustment range 22 to 23" Wide)	NC

\*Additional +1" of shell width adjustment is achievable. Requires purchase of 1" larger foam and upholstery separately.

**B - JAY® Syncra™ Back Shell Options and Height Ranges**

\$

JAY® Syncra™ Back shells are mounted with a minimim 5.5" gap between the bottom of the shell to the seat pan to accommodate the mechanical shear. Back height can be adjusted in the field with-in the ranges shown based on the back frame type.

**JAY® Syncra™ Shell Height**

300JR42	–	16" Tall Shell (22" to 24" Back Height)	NC
300JR43	–	18" Tall Shell (24" to 26" Back Height)	NC
300JR44	–	20" Tall Shell (26" to 28" Back Height)	NC
300JR45	–	22" Tall Shell (28" to 30" Back Height)	NC

## POWERED SEATING

OPTION	HCPC	DESCRIPTION	RETAIL
--------	------	-------------	--------

**JAY® Syncra™ Back Installed Back Height (From Pan to Top of Back)**

300JR50	–	22" (16" Shell Height)	NC
300JR51	–	23" (16" Shell Height)	NC
300JR52	–	24" (16" Shell Height)	NC
300JR53	–	24" (18" Shell Height)	NC
300JR54	–	25" (18" Shell Height)	NC
300JR55	–	26" (18" Shell Height)	NC
300JR56	–	26" (20" Shell Height)	NC
300JR57	–	27" (20" Shell Height)	NC
300JR58	–	28" (20" Shell Height)	NC
300JR67	–	28" (22" Shell Height)	NC
300JR68	–	29" (22" Shell Height)	NC
300JR69	–	30" (22" Shell Height)	NC

**B - JAY® Syncra™ Back Upholstery** \$

300BU96	–	Syncra™ Premium Leatherette	NC
300BU97	–	Syncra™ Stretch	NC

**B - JAY® Syncra™ Fixed Lateral Support Accessory** \$**JAY® Fixed Lateral Support Accessory Hardware** (JAY® Fixed Lateral Support is height adjustable)

300JW33	E0956	Fixed Lateral Support Accessory (L x H) 90 mm x 140 mm / 3.5" x 8" - Right	\$144.00
300JW34	E0956	Fixed Lateral Support Accessory (L x H) 90 mm x 140 mm / 3.5" x 8" - Left	\$144.00

**C - JAY® J3® Back****C - JAY® J3® Back - Contour**  P. 22 \$

300JP01	E2613	J3® PA Back for 16"-20" Wide	\$613.00
300JP02	E2614	J3® PA Back for 22" Wide	\$910.00
300JP11	E2615	J3® PL Back for 16"-20" Wide	\$715.00
300JP13	E2620	J3® PD Back for 16"-20" Wide (18" and 21" Shell Height Only)	\$858.00

**C - JAY® J3® Back Width** \$

Back can be ordered a different width than seat pan. Armrest will be adjusted to back width ordered.

300JQ02	–	16"	NC
300JQ03	–	18"	NC
300JQ04	–	20"	NC
300JQ05	–	22"	NC

## POWERED SEATING

OPTION	HCPC	DESCRIPTION	RETAIL
--------	------	-------------	--------

## C - JAY® J3® Back Shell Options and Height Ranges

\$

JAY® J3® shells are mounted with a minimum 4" gap between the bottom of the shell to the seat pan to accommodate the mechanical shear. Back height can be adjusted in the field within the ranges shown.

## JAY® J3® Shell Height

			Tool Angle Adjust.	150° Recline	Installed Back Height	
300JR41	–	15" tall shell (Upper Thoracic Med) for 22" Wide	22"-23"	22"-23"		NC
300JR14	–	16.5" tall shell (Upper Thoracic Short)	21"-23"	22"-24"		NC
300JR15	–	18" tall shell (Upper Thoracic Med)	22"-24"	23"-25"		NC
300JR16	–	19.5" tall shell (Upper Thoracic Tall)	24"-26"	24"-26"		NC
300JR18	–	18" tall shell (Shoulder Height) for 22" wide	24"	24"		NC
300JR17	–	21" tall shell (Shoulder Height)	24"-26"	25"-28"		NC
300JR27	–	22.5" tall shell (Shoulder Height)	26"-28"	27"-30"		NC
300JR28	–	24" tall shell (Shoulder Height)	27"-29"	28"-30"		NC

## JAY® J3® Installed Back Height (From Pan to Top of Back)

300JR29	–	21"			NC
300JR19	–	22"			NC
300JR20	–	23"			NC
300JR21	–	24"			NC
300JR22	–	25"			NC
300JR23	–	26"			NC
300JR24	–	27"			NC
300JR25	–	28"			NC
300JR30	–	29"			NC
300JR31	–	30"			NC

C - JAY® Anterior Thoracic Support  P. 22

\$

Classic-Structure Pull Down Harness (4 point strap, only available with JAY® backrest)

300K10	E0960	Medium (ATS8302)	\$174.00
300K11	E0960	Large (ATS8303)	\$174.00





## POWERED SEATING

OPTION	HCPC	DESCRIPTION	RETAIL
<b>JAY® Lateral Thoracic Swing-Away Supports (Requires Pad, Upholstery and Mount)</b>			\$
<b>JAY® Lateral Thoracic Support Pads</b>			
300JW35	E0956	Lateral Thoracic (L x H) 100 mm x 127 mm / 4" x 5" Pad - Right	\$144.00
300JW38	E0956	Lateral Thoracic (L x H) 100 mm x 127 mm / 4" x 5" Pad - Left	\$144.00
300JW36	E0956	Lateral Thoracic (L x H) 100 mm x 152 mm / 4" x 6" Pad - Right	\$144.00
300JW39	E0956	Lateral Thoracic (L x H) 100 mm x 52 mm / 4" x 6" Pad - Left	\$144.00
300JW37	E0956	Lateral Thoracic (L x H) 152 mm x 100 mm / 6" x 4" Pad - Right	\$144.00
300JW40	E0956	Lateral Thoracic (L x H) 152 mm x 100 mm / 6" x 4" Pad - Left	\$144.00
<b>JAY® Lateral Thoracic Support Pad Upholstery</b>			
300NU01	–	Syncra™ Premium Leatherette	NC
300NU02	–	Syncra™ Stretch	NC
<b>JAY® Lateral Thoracic Swing-Away Mount</b>			
300JW41	E1028	Lateral Thoracic Swing Away Bracket - Right	\$286.00
300JW42	E1028	Lateral Thoracic Swing Away Bracket - Left	\$286.00
<b>Headrests (Requires Pad, Upholstery, &amp; Mount)  P. 24</b>			\$
<b>Headrest Pad</b>			
300HE36	E0955	SEDEO® Pad Small with Cover (LxH) 240 x 150 mm / 10" x 6" <i>Can only be used with Multi Position Headrest Mount with quick-release and SEDEO® upholstery</i>	\$184.00
300HE38	E0955	Whitmyer® Plush Headrest Pad 203 mm / 8"	\$234.00
300HE39	E0955	Whitmyer® Plush Headrest Pad 254 mm / 10"	\$234.00
300HE44	E0955	Whitmyer® Plush Headrest Pad 356 mm / 14"	\$245.00
300HE46	E0955	Whitmyer® Adjust-A-Plush Headrest Pad Medium <i>(Adjustable 7" to 16" Wide x 4" Tall)</i>	\$360.00
300HE48	–	OMIT Headrest Pad	NC
<b>Headrest Pad Upholstery</b>			
300NU10	–	SEDEO® Upholstery	NC
300NU04	–	Syncra™ Premium Leatherette	NC
300NU11	–	Whitmyer® Lycra / Stretch	NC
<b>Headrest Mount</b>			
300MH32	E1028	SEDEO® Multi-Position Headrest Mount with Quick Release <i>(Only available with SEDEO® Pad)</i>	\$229.00
300MH33	E1028	Whitmyer® Linx Headrest Mount with Quick Release	\$188.00
300MH34	E1028	Whitmyer® Linx-2 Headrest Mount with Quick Release	\$229.00
300MH35	E1028	Whitmyer® AXYS Headrest Mount with Quick Release	\$121.00
300MH17	–	OMIT Headrest Mount	NC

**POWERED SEATING**

OPTION	HCPC	DESCRIPTION	RETAIL
<b>Push Handles</b>			<b>\$</b>
300PH27	–	Height Adjustable Push Handles	\$343.00
<b>Seat Frame Rails</b>			<b>\$</b>
300SN14	–	Seat Rail Short, for Effective Seat Depth 14" - 18"	NC
300SN15	–	Seat Rail Long, for Effective Seat Depth 17" - 22"	NC
<b>Seat Cushion Type</b>			<b>\$</b>
300ST79	–	SEDEO® (See Section D)	NC
300ST81	–	JAY® Syncra™ (See Section E)	NC
300ST80	–	JAY® (See Section F)	NC
300ST75	–	Omit	NC
<b>Seat Size</b>			<b>\$</b>
<b>Seat Pan Width (Odd sizes not available on SEDEO® cushions)</b>			
300R53	–	16"	NC
300R54	–	17"	NC
300R55	–	18"	NC
300R56	–	19"	NC
300R57	–	20"	NC
300R58	–	21" (Not available with JAY® Syncra™ Cushions)	NC
300R59	–	22"	NC
<b>Seat Pan Depth (Front of seat pan to front of back cushion – effective depth)</b>			
300RF52	–	14"	NC
300RF53	–	15"	NC
300RF51	–	16"	NC
300RF45	–	17"	NC
300RF46	–	18"	NC
300RF47	–	19"	NC
300RF48	–	20"	NC
300RF49	–	21" (Not available with JAY® Syncra™ Cushions)	NC
300RF50	–	22"	NC
<b>D - SEDEO® Cushions</b>			<b>\$</b>
300CU82	E2607	SEDEO® Cushion (Sizes 16", 18", & 20" Wide) (Not available with 14" depth)	\$451.00
300CU83	E2608	SEDEO® Cushion (Sizes 22" Wide)	\$567.00

**POWERED SEATING**

OPTION	HCPC	DESCRIPTION	RETAIL
<b>E - JAY® Syncra™ Cushion</b>  P. 21 (JAY Your Way modifications available through Customer Service (800) 333-4000)			\$
300CU89	E2622	JAY® Syncra™ Cushion featuring JAY Flow® Fluid with Cryo™ Technology (16" to 20" wide)	\$618.00
300CU90	E2623	JAY® Syncra™ Cushion featuring JAY Flow® Fluid with Cryo™ Technology (22" wide)	\$715.00
<b>JAY® Syncra™ Cushion Cover Upholstery</b>			
300YR73	–	Syncra™ Premium Leatherette	NC
300YR74	–	Syncra™ Stretch	NC
<b>F - JAY® Seat Cushion</b>  P. 23			\$
300CU59	E2607	JAY® Ion® (Sizes 16" to 21" Wide)	\$451.00
300CU60	E2608	JAY® Ion® (Size 22" Wide)	\$567.00
300CU61	E2607	JAY® Union® (Sizes 16" to 21" Wide)	\$510.00
300CU62	E2608	JAY® Union® (Size 22" Wide)	\$623.00
300CU64	E2622	JAY® Fusion® (Sizes 16" to 21" Wide)	\$504.00
300CU65	E2623	JAY® Fusion® (Size 22" Wide)	\$601.00
<b>F - JAY® Solid Seat</b>			\$
300CU84	–	JAY® Solid Seat	\$98.00

## POSITIONING SUPPORTS & ACCESSORIES

OPTION	HCPC	DESCRIPTION	RETAIL
--------	------	-------------	--------

### Knee and Thigh Swing-Away Support Pads

\$

#### Lateral Knee Support Pads and Hardware (must pick pad and mount)

300XY05	E0953	Lateral Knee Support Pad, Right (4" round)	\$201.00
300XY06	E0953	Lateral Knee Support Pad, Left (4" round)	\$201.00
300XX08	E1028	Lateral Swing-Away Bracket Knee - Right	\$263.00
300XX09	E1028	Lateral Swing-Away Bracket Knee - Left	\$263.00

#### Lateral Thigh Support Pads and Hardware (must pick pad and mount)

300KF22	E0953	Lateral Thigh Support Pad Short - Right (4.8" H x 4.8" L / 120mm x 120mm)	\$144.00
300KF23	E0953	Lateral Thigh Support Pad Short - Left (4.8" H x 4.8" L / 120mm x 120mm)	\$144.00
300KF24	E0953	Lateral Thigh Support Pad Long - Right (4.8" H x 7" L / 120mm x 120mm)	\$144.00
300KF25	E0953	Lateral Thigh Support Pad, Long - Left (4.8" H x 7" L / 120mm x 120mm)	\$144.00
300KF26	E1028	Lateral Thigh Removable Mount - Right	\$286.00
300KF27	E1028	Lateral Thigh Removable Mount - Left	\$286.00

### JAY® Lateral Thigh Supports (Must pick pad, upholstery, and mount)

\$

#### JAY® Lateral Thigh Support Pads

300KF16	E0953	Lateral Thigh Support Pad Standard, Right (8.25" x 3.25")	\$144.00
300KF17	E0953	Lateral Thigh Support Pad Standard, Left (8.25" x 3.25")	\$144.00
300KF18	E0953	Lateral Thigh Support Pad Large, Right (12" x 3.25")	\$144.00
300KF19	E0953	Lateral Thigh Support Pad Large, Left (12" x 3.25")	\$144.00

#### JAY® Lateral Thigh Support Pad Upholstery

300NU07	–	Syncra™ Premium Leatherette	NC
300NU08	–	Syncra™ Stretch	NC

#### JAY® Lateral Thigh Removable Mount

300KF20	E1028	Lateral Thigh Removable Mount - Right	\$286.00
300KF21	E1028	Lateral Thigh Removable Mount - Left	\$286.00

### Armrest Structure P. 23

\$

300EG35	–	Reclining, Flip Back, Long (Height Adjustable 9" to 15")	NC
300EG41	–	Reclining, Flip Back, Short (Best used with shorter seat depths) (Height Adjustable 9" to 15")	NC
300EG36	–	Reclining, Flip Back with 2-point post locking arm. (Height Adjustable 11" to 15" x 0.625")	\$286.00
300EG32	–	Single Post, Flip Back (N/A with thigh support) (Height Adjustable 10" to 15")	NC

### Arm Pads P. 23

\$

#### SEDEO® Armrest Pad

300AB43	–	300 mm / 12", Integral Foam, Right	NC
300AE43	–	300 mm / 12", Integral Foam, Left	NC
300AB44	–	400 mm / 16", Integral Foam, Right	NC
300AE44	–	400 mm / 16", Integral Foam, Left	NC

#### Comfort Arm Pad (Foam)

300AB46	–	2" Wide Right	\$86.00
300AE46	–	2" Wide Left	\$86.00

## POSITIONING SUPPORTS & ACCESSORIES

OPTION	HCPC	DESCRIPTION	RETAIL
<b>Comfort Arm Pad (Gel)</b>			
300AB48	–	2" Wide Right	\$172.00
300AE48	–	2" Wide Left	\$172.00
<b>Ottobock® Arm Troughs</b>			
300AE06	–	Ottobock Arm Trough, Med Left	\$133.00
300AB06	–	Ottobock Arm Trough, Med Right	\$133.00
300AE07	–	Ottobock Arm Trough, Large Left	\$133.00
300AB07	–	Ottobock Arm Trough, Large Right	\$133.00
300OL01	–	Ottobock Hand Pad, Med Left	\$58.00
300OR01	–	Ottobock Hand Pad, Med Right	\$58.00
300OL02	–	Ottobock Hand Pad, Large Left	\$58.00
300OR02	–	Ottobock Hand Pad, Large Right	\$58.00
300AE78	–	Ottobock One Piece Arm Trough, Left	\$186.00
300AB78	–	Ottobock One Piece Arm Trough, Right	\$186.00
<b>Side Guards (Pair)</b>			\$
300SG44	E0953	Side Guards Integral Foam (11"L x 5.5"H) (N/A with Reclining Armrests)	\$234.00
<b>Fixed Centermount Legrest</b>			\$
300H183	–	SEDEO® Seating Fixed Centermount Legrest (3" to 17.5" Leg Length)	\$286.00
300H184	–	Fixed Centermount Legrest, Short (Includes Calf Pads and Single Footplate) (11.5" to 14.5" Leg Length)	NC
300H185	–	Fixed Centermount Legrest, Long (Includes Calf Pads and Single Footplate) (13.5" to 18.5" Leg Length)	NC
<b>Power Centermount Legrest  P. 23</b>			\$
300H175	E1012	Power Centermount Legrest, 90° - 0° Angle, 7.5" Extension (Mechanical Articulation) (5" to 17.5" Leg Length)	\$2,653.00
300H109	E1012	Power Centermount Legrest, 90° - 0° Angle, 7.5" Extension (Powered Articulation) (3" to 17.5" Leg Length)	\$3,717.00
<b>Centermount Legrest Accessories</b>			\$
<b>Footplates</b>			
300F127	K0040	Dual, Height, Width and Angle Adjustable, Standard (14"W x 10"D)	\$193.00
300F128	K0040	Dual, Height, Width and Angle Adjustable, Large (16"W x 12"D)	\$193.00
<b>Calf Pad Options</b>			
300DI34	–	Calf Pads, Pair, Standard Integral Foam	NC
300DI35	–	Calf Pads, Pair, Padded (N/A w/ Std footplate)	\$400.00
<b>SEDEO® PRO™ Swing-Away Legrest (Pair) (Footplates, calf supports &amp; options must be selected separately.)</b>			\$
300H177	–	Legrests, Swing-Away, 70°, SEDEO® PRO™ (14" to 21" Leg Length)	NC
300H178	E0990	Legrests, Manual Elevating, Swing-Away, SEDEO® PRO™ (Includes Padded Calf Pads) (14.5" to 21.5" Leg Length)	\$400.00
300H179	E1010	Legrests, Power Elevating, Swing-Away, SEDEO® PRO™ (Includes Padded Calf Pads) (15.5" to 22.5" Leg Length)	\$2,459.00
300DI76	–	Omit Legrests	NC

## POSITIONING SUPPORTS & ACCESSORIES

OPTION	HCPC	DESCRIPTION	RETAIL
<b>Swing-Away Legrest Footplates</b>			
300F369	K0040	Angle Adjustable Flip-Up Footplates	\$193.00
<b>Swing-Away Legrest Calf Supports</b>			
300DI42	–	Calf Support, Depth Adjustable, Padded <i>(6.5" to 8" Wide, depending on chair width, x 9.5" Tall)</i>	\$451.00
<b>Swing-Away Legrest Options</b>			
300DI44	E0951	Heel Loops	\$57.00
300KG4	–	Knee Pads, Integral Foam <i>(2.5" Wide x 4.5" Tall)</i>	\$229.00
<b>SEDEO® Lower Extremity Swing-Away Support</b>			
300VD01	E1020	Lower Extremity Support, Padded, Swing-Away, SEDEO®, Right	\$451.00
300VD02	E1020	Lower Extremity Support, Padded, Swing-Away, SEDEO®, Left	\$451.00
<b>Pelvic Positioning Belts  P. 23</b>			
300A837	–	Positioning Belt, Auto Style Buckle, 50 mm 1600 mm / 2"	NC
300A839	–	Positioning Belt, Aircraft Buckle, 50 mm x 1300 mm / 2"	NC
300A840	E0978	Positioning Belt, Aircraft Buckle, Padded 50 mm x 1300 mm / 2"	\$86.00
300A845	K0108	Bodypoint – Evoflex Pelvic Stabilizer Belt	\$199.00
300A846	K0108	Bodypoint – Evoflex Pelvic Stabilizer Belt with Extension	\$220.00
<b>Accessories</b>			<b>\$</b>
<b>Ventilator Option</b>			
300VT12	E1029	Vent Tray Fixed <i>(Pulmonetic LTV Models)</i>	\$531.00
<b>O2 Tank Option</b>			
300A718	E2208	O2 Tank Holder Mounted to Backrest <i>(D and E Styles)</i>	\$372.00
<b>Wheelchair Tray Table</b>			
3007A09	E0950	Tray, Swing-Away	\$400.00
<b>Backpack</b>			
300A1	–	Black Utility	\$62.00
<b>Medial Thigh Support</b>			
3008A80	E0957	Medial Thigh Support	\$193.00
3008A81	E1028	Pommel Swing-Away Hardware	\$286.00
<b>Misc. Accessories</b>			
3008A59	–	Transfer Bar <i>(Pair)</i>	\$400.00
3008A52	–	Ram Mount Phone	\$98.00
3008A53	–	Ram Mount Tablet	\$400.00
3008A54	–	Ram Mount Cup Holder	\$98.00
3008A58	–	Rear View Mirror	\$98.00
300A611	–	Crutch Holder	\$144.00
3008A73	–	Bag For Armrest	\$98.00
3008A75	–	Reflectors <i>(Backrest shroud mounted)</i>	\$98.00
3009A10	–	Utility Hooks	\$59.00

**JOYSTICK / ELECTRONICS****VR-2 Joystick**

\$

300J127	–	VR-2 Joystick	NC
---------	---	---------------	----

**R-net Joystick (Remote)**  P. 24

\$

300J121	–	Standard LED Joystick ( <i>w/o Screen Display</i> )	NC
300J116	–	Color Joystick ( <i>2.3" Color LCD Screen Display, CJSM1</i> )	NC
300J118	–	High Resolution Color Joystick, (CJSM2+BT) <i>3.5" Color LCD Display, Paddle Switches, Programmable Shortcut Keys, ICONs, Stereo Jack, IR and dual (IOS/Android) Bluetooth control</i>	\$1,206.00
300J119	–	Omit Remote Control ( <i>Required with arm mounted specialty controls</i> )	NC

**Joystick Mounting**

\$

300JM34	–	Fixed on Armrest	NC
300JM35	E1028	Parallel Swing-Away	\$338.00
300JM36	E1028	Link-It Mid Line Mount on Armrest ( <i>Swing-Away</i> )	\$972.00

**Joystick Mount (Location)**

\$

300HM16	–	Right Hand Armrest	NC
300HM17	–	Left Hand Armrest	NC

**Display Language Selection R-net**

\$

300L1	–	English	NC
300L3	–	French	NC
300L7	–	Spanish	NC

**Joystick Handle (Optional)**  P. 24

\$

300JH13	E2323	Ball Handle	\$144.00
300JH15	E2323	T-Handle	\$144.00
300JH24	E2323	Bodypoint – Rubber Dome Joystick Handle	\$187.00
300JH25	E2323	Bodypoint – U-Shaped Joystick Handle ( <i>4 in</i> )	\$187.00
300JH26	E2323	Bodypoint – Grooved Mushroom Joystick Handle	\$187.00

**Electronic Programmers**  P. 25

\$



300PR10	–	R-net PC Programmer w/ Dongle	\$601.00
---------	---	-------------------------------	----------

**R-net Power Modules**  P. 25

\$

300ER12	–	Power Module, VR-2 90A, Non-Expandable	NC
300ER22	–	Power Module, R-net, 90A, Non-Expandable ( <i>Only available with single power</i> )	NC
300ER13	–	Power Module, R-net, 90A, Expandable ( <i>Required for Specialty Controls or 2+ Actuators</i> )	\$1,309.00
300EX11	E2377	Expandable 90A Controller - R-net	\$692.00
300EX12	E2313	Harness for 90A Expandable Controller	\$617.00

## JOYSTICK / ELECTRONICS

OPTION	HCPC	DESCRIPTION	RETAIL
<b>Seating Control</b>			\$
<b>Powered Seating Control</b>			
300E040	–	Omit Thru-Drive <i>(Requires Switch Control)</i>	NC
300E037	E2310	Thru-drive Control for 1 Actuator	\$2,196.00
300E038	E2311	Thru-drive Control for 2+ Actuators	\$3,975.00
<b>Switch Control</b> <i>(Available with Omit Thru-Drive only) (1 Actuator for Tilt or Elevate only)</i>			
300E033	–	Dual Toggle for 1 Actuator	NC
300E034	–	2.5" Single Button Switch for 1 Actuator	NC
300E041	–	Ctrl+5 Switch Box for 2 Actuators or more	NC
<b>Additional Power Seating Control</b> <i>(Available with Thru-Drive only)</i>			
300QG11	–	Ctrl+5 Switch Box with Free Assignable Functions	\$1,430.00
300QG12	–	Ctrl+5 Switch Box with Free Assignable Functions <i>(Multi-power only)</i>	NC
<b>Dual Toggle Mounting Location</b>			
300TN1	–	Toggle Mount, Right	NC
300TN2	–	Toggle Mount, Left	NC
<b>Ctrl+5 Mounting location</b>			
300EY19	–	Right Armrest	NC
300EY20	–	Left Armrest	NC
300EY21	–	Back Cane, Right	\$172.00
300EY24	–	Back Cane, Left	\$172.00
<b>Ctrl+5 Switch Type</b>  P. 25			
300EY22	–	Push Buttons	NC
300EY23	K0108	Toggle Switches	\$343.00
<b>Attendant Controls</b>  P. 25			\$
3000A05	E2331	Dual Control Module for Attendant	\$1,487.00
3000A06	E2331	R-net Color LCD (CJSM1), Control Attendant Only	\$1,487.00
<b>Attendant Mounting Location</b>			\$
300DN5	–	Right Back Cane	NC
300DN6	–	Left Back Cane	NC



## JOYSTICK / ELECTRONICS

OPTION	HCPC	DESCRIPTION	RETAIL
<b>R-net Programming</b>			\$
<b>Assignable Buttons</b>			
<i>Assignable Button feature allows for personalization of joystick buttons and/or Ctrl+5 Switches allowing access to various wheelchair and seating functions. When enabled, chair will be pre-programmed with seating functions assigned to buttons on the joystick. Assignments can be changed via PC Dongle.</i>			
300PM12	–	Include Assignable Buttons	NC
<b>Power Centermount Footplate Extension Option</b>			
300IE03	K0108	Include 7.5" Powered Footplate Extension for Transfer Assist ( <i>Electronics programmed to allow footplates to be extended with or without legrest being raised.</i> ) Only Available with Powered Articulation	\$1,430.00
<b>R-net Omni2 Options</b>  P. 25 <i>For Expandable Controls, choose all that apply.</i>			\$
300ON14	–	R-net Omni2 Only Input Control Module and 3.5" LCD Display w/ Built-In Infrared and Bluetooth® Choose Mount Below	\$2,031.00
300ON15	–	R-net Omni2 Bundled Input Control Module and 3.5" LCD Display w/ Built-In Infrared and Bluetooth® Bundled Omni2 Available w/ Switch-It Input Devices	NC
<b>Omni2 Mount</b> <i>If used w/ Standard Joystick, it must be mounted opposite side.</i>			\$
300DS14	E1028	Link-It with Parallel Swing-Away Omni2 Mount w/Rear Mounted Interface, Right	\$567.00
300DS15	E1028	Link-It with Parallel Swing-Away Omni2 Mount w/Rear Mounted Interface, Left	\$567.00

## SPECIALTY INPUT DEVICES

OPTION	HCPC	DESCRIPTION	RETAIL
--------	------	-------------	--------

Hand Control Packages  P. 25 *Requires Standard Joystick Omit / Only one hand control device can be ordered.* \$

## Proportional Input Devices

300EU14	E2312	Switch-It MicroGuide	\$3,769.00
300EU15	E2312	Switch-It MicroPilot	\$3,769.00
300EU17	E2328	Switch-It VersaGuide	\$2,076.00
300EU18	E2328	Switch-It VersaGuide EZ	\$2,453.00

## Mounting Position (Required)

300EM04	–	Link-It to the Backrest <i>(Not Available w/ Omit Back Cushion Type)</i>	\$1,087.00
300EM05	–	Link-It to the Fixed Joystick Mount	\$338.00
300EM06	E1028	Link-It to the Parallel Swing-Away Joystick Mount	\$567.00
300EM07	E1028	Link-It to the Midline Swing-Away	\$1,201.00
300EM08	–	Omit Mount	NC

Mounting Platforms (Optional) *Not available w/ Link-It to Backrest*

300MG16	E0950	SunDisk Hand Tray <i>(Only available w/ MicroSeries Joysticks)</i>	\$338.00
300MG15	E0950	Bullet Hand Tray	\$338.00

## Mounting Location (Required)

300IM09	–	Right	NC
300IM10	–	Left	NC

## Switch Options

–	–	See Switch Selections <i>(Maximum 2)</i>	–
---	---	--	---

Head Control Packages  P. 26 *(Select headrest mount on next page)* \$

*Only one head control device can be ordered.*

## Proportional Input Devices

300EU25	E2328	Switch-It DualPro® Proportional Head Array - Facial Pads	\$6,537.00
300EU26	E2328	Switch-It DualPro® Proportional Head Array - Spot Pads	\$6,537.00
300EU51	E2328	Switch-It Vigo Head Drive	\$5,537.00

## Switched Input Devices

300EU28	E2330	Switch-It 3-Switch Head Array - Short Curved Wings	\$5,026.00
300EU30	E2330	Switch-It 3-Switch Head Array - Long Curved Wings	\$5,026.00

## Switch Options

–	–	See Switch Selections <i>(Maximum 2)</i>	–
---	---	--	---

## SPECIALTY INPUT DEVICES

OPTION	HCPC	DESCRIPTION	RETAIL
<b>Sip 'N Puff</b>			\$
300ID73	E2330	Switch-It Sip 'N Puff Combo Head Array with Link-It Hardware <i>(Requires headrest mount)</i>	\$5,713.00
300ID74	K0108	Switch-It OptiStop with Sip 'N Puff	\$2,225.00
<b>Headrest Mounts</b> <i>(Applies to Head/Sip 'N Puff control packages)</i>			\$
300IJ13	E1028	Whitmyer® Linx Headrest Mount with Quick Release	\$188.00
300IJ14	E1028	Whitmyer® Linx-2 Headrest Mount with Quick Release	\$229.00
300IJ15	E1028	Whitmyer® AXYS Headrest Mount with Quick Release	\$121.00
<b>Chin Control Packages</b>  P. 26			\$
<b>Proportional Input Devices</b>			
300EU34	E2312	Switch-It MicroGuide <i>(Switches mounted to the headrest only.)</i>	\$3,769.00
300EU35	E2312	Switch-It MicroPilot <i>(Switches mounted to the headrest only.)</i>	\$3,769.00
300EU36	E2328	Switch-It VersaGuide	\$2,076.00
300EU37	E2328	Switch-It VersaGuide EZ	\$2,453.00
<b>Mounting Position</b>			
300EM09	E1028	Link-It To Chin Harness, Small (150mm / 6")	\$1,430.00
300EM10	E1028	Link-It To Chin Harness, Large (220mm / 8")	\$1,430.00
300EM11	E1028	Link-It To Headrest, Swing-Away	\$1,430.00
300EM16	E1028	Omit Mount	NC
<b>Input Device Mounting Location</b>			
300IM13	–	Right	NC
300IM14	–	Left	NC
<b>Switch Options</b>			
–	–	See Switch Selections	–
<b>Safety Devices</b>			\$
300SA06	–	Switch-It Remote Stop Switch - XLR Connector	\$1,070.00
<b>Switched Driving Packages</b>			\$
300SW44	E2328	Switch-It™ Cool Cube with DB9 connector for proximity/proportional switch driving. <i>(Pro Spot proportional switches are required if proportional driving is desired.) (For non-proportional driving, single switches can be used.)</i>	\$3,969.00

## SPECIALTY INPUT DEVICES

OPTION	HCPC	DESCRIPTION	RETAIL
--------	------	-------------	--------

Switches  P. 26

Single switches can be programmed to activate any function of the wheelchair including: On/Off, Mode, Profile, Speeds, Seating, Memory Positions, Horn, Lights & Indicators, IR functions, Bluetooth mouse clicks, Environmental Controls when plugged into assignable port.

Switches can connect via: Joysticks (Standard, Micro series, Versa series) Omni2, SJX6 Hub, head controls

Switch ordering instructions:

1. Select switch type and quantity in Section "A" using columns below. (Max 6 switches. See limitations below.)
2. Select switch mounting position from Section "B" using corresponding switch column.
3. Select switch mounting location from Section "C" using corresponding switch column.

## Section A – Switch Selections

## Switch / Quantity

Single Function Switches - Mechanical Switches	Switch 1	Switch 2	Switch 3	Switch 4	Switch 5	Switch 6	\$
2.5" Single Switch - Black							\$223.00
2.5" Single Switch - Blue							\$223.00
2.5" Single Switch - Green							\$223.00
2.5" Single Switch - Red							\$223.00
2.5" Single Switch - Yellow							\$223.00
Egg Switch - Black							\$126.00
Egg Switch - Blue							\$126.00
Egg Switch - Green							\$126.00
Egg Switch - Red							\$126.00
Egg Switch - Yellow							\$126.00
MicroLite <i>(Includes color labels)</i>							\$188.00
Mini Button 1 - Blue <i>(Velcro)</i>							\$121.00
Mini Button 1 - Green <i>(Velcro)</i>							\$121.00
Mini Button 1 - Red <i>(Velcro)</i>							\$121.00
1" Single Switch - Black							\$315.00
1" Single Switch - Blue							\$315.00
1" Single Switch - Green							\$315.00
1" Single Switch - Orange							\$315.00
1" Single Switch - Red							\$315.00
1" Single Switch - Yellow							\$315.00
<b>Electronic Switches</b>							
Flex Switch (Headrest mount only)							\$245.00
<b>ProSpot - Proportional Switches</b>							
ProSpot Proportional Switch - Red							\$543.00
ProSpot Proportional Switch - Green							\$543.00
ProSpot Proportional Switch - Blue							\$543.00
ProSpot Proportional Switch - Yellow							\$543.00
ProSpot Proportional Switch - Orange							\$543.00

## Section B – Switch Mounting Position

Link-It to the Backrest <i>(Up to 1 per side)</i>							\$744.00
Link-It to the Headrest - Gooseneck & Rigid <i>(Up to 2 per side)</i>							\$744.00
Link-It to the Fixed Joystick Mount <i>(Up to 2 per side)</i>							\$567.00
Link-It to the Parallel Swing-Away Joystick Mount <i>(Up to 2 per side)</i>							\$567.00
Link-It to the Seat Rail <i>(Up to 2 per side)</i> <i>(Not avail w/knee &amp; thigh supports)</i>							\$451.00
Omit Mount <i>(includes Velcro)</i>							NC

## Section C – Switch Mounting Location

Right side of chair							NC
Left side of chair							NC

## Joystick Integrated Switches (Pair)

300J003	–	Proximity Switches on Flex Mount, Pair <i>(Used with VersaGuide/VersaGuide EZ)</i>					\$1,138.00
---------	---	--	--	--	--	--	------------

## JAY® SYNCRA™ SEATING MEASURING GUIDE

### JAY® SYNCRA™ BACK



<b>Backrest Width</b>	16"	18"	20"	22"
<b>Max User Trunk Width</b>	13.5"	15.5"	17.5"	19.5"

#### JAY® Swing-Away Lateral Thoracic Adjustment Range

Syncra Back Width	Width Range	Height range from bottom of shell to seat pan
16"	10" to 24"	12" to 19.5"
18"	12" to 26"	12.5" to 21.5"
20"	14" to 28"	12.5" to 22"
22"	16" to 30"	13.5" to 23"

#### Syncra™ Fixed Lateral Support Accessory Range

Syncra Back Width	Width Range	Height range from bottom of shell to seat pan	Contour Depth Range
16"	16.4" to 16.8"	6" to 8"	3" to 5"
18"	18.4" to 18.8"	6" to 8"	3" to 5"
20"	20.4" to 20.8"	6" to 8"	3" to 5"
22"	22.4" to 22.8"	6" to 8"	3" to 5"

#### Syncra™ Back Shell Height Diagram

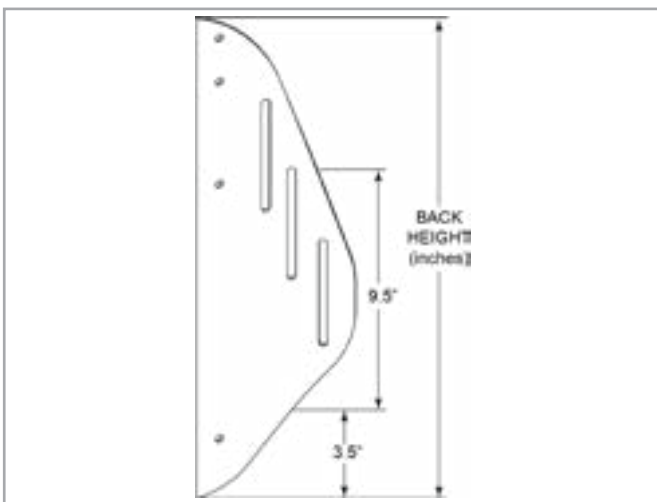

### JAY® SYNCRA™ CUSHION



#### JAY® Lateral Thigh Support Adjustment Range

Syncra Cushion Width	Width Range
16"	8.5" to 16.0"
17"	9.5" to 17.0"
18"	10.5" to 18.0"
19"	11.5" to 19.0"
20"	12.5" to 20.0"
22"	14.5" to 22.0"



Q500 M with SEDEO® PRO™

\$

Base Price

Total of additional equipment

Packaging and transport

Total Price

Date

Signature

Month

Day

Year

