

Mark For: _____

Date: _____

Dealer Acct #: _____

Dealer: _____

Dealer Contact: _____

Dealer Address: _____

Dealer City: _____

ST: _____

ZIP: _____

Dealer Phone: () _____

Fax: () _____

Confirmation Email: _____

Confirm Via:

 Fax

 Email

Submitting for:
 Quote

 Order

PO#: _____

ADDITIONAL SHIPPING INFORMATION

Ship To: _____

Attention: _____

Address: _____

Address: _____

Ship To City: _____

ST: _____

ZIP: _____

Ship To Phone: () _____





Fax: () _____

The **HCPCS CODES** herein are based on PDAC verification or interpretation of Medicare definitions and guidelines. Non-Medicare payers may accept alternative **HCPCS CODES**, including misc. codes to ensure access for their enrollees. The use of **HCPCS CODES** does not ensure coverage or payment.

Note: For cover selection, **L** = Lycra and **V** = Dartex Reversed (Example: AXYS-HUFALL **L** or AXYS-HUFAL **V**)

Head Positioning - Use HCPCS Code E0955



Whitmyer headrests come unassembled. Please add item WHITASSY001 if the dealer would like parts assembled. This is a no charge option.

	<input type="checkbox"/> Receiver must be selected on pg 2		<input type="checkbox"/> Receiver must be selected on pg 2		<input type="checkbox"/> Receiver must be selected on pg 2		<input type="checkbox"/> Receiver must be selected on pg 2
---	--	---	--	--	--	---	--

PAD		AXYS		ONYX		LINX		LINX ²	
HEADS UP - COMMON SIZES	Fixed Arm	Large	<input type="checkbox"/> AXYS-HUFALL \$295	<input type="checkbox"/> ONYX-HUFALL \$295	<input type="checkbox"/> LINX-HUFALL \$295	<input type="checkbox"/> LINX2-HUFALL \$330			
			<input type="checkbox"/> AXYS-HUFALV \$295	<input type="checkbox"/> ONYX-HUFALV \$295	<input type="checkbox"/> LINX-HUFALV \$295	<input type="checkbox"/> LINX2-HUFALV \$330			
		Medium	<input type="checkbox"/> AXYS-HUFAML \$295	<input type="checkbox"/> ONYX-HUFAML \$295	<input type="checkbox"/> LINX-HUFAML \$295	<input type="checkbox"/> LINX2-HUFAML \$330			
			<input type="checkbox"/> AXYS-HUFAMV \$295	<input type="checkbox"/> ONYX-HUFAMV \$295	<input type="checkbox"/> LINX-HUFAMV \$295	<input type="checkbox"/> LINX2-HUFAMV \$330			
		Small	<input type="checkbox"/> AXYS-HUFASL \$295	<input type="checkbox"/> ONYX-HUFASL \$295	<input type="checkbox"/> LINX-HUFASL \$295	<input type="checkbox"/> LINX2-HUFASL \$330			
			<input type="checkbox"/> AXYS-HUFASV \$295	<input type="checkbox"/> ONYX-HUFASV \$295	<input type="checkbox"/> LINX-HUFASV \$295	<input type="checkbox"/> LINX2-HUFASV \$330			
	Early Intervention	<input type="checkbox"/> AXYS-HUFAEIL \$295	<input type="checkbox"/> ONYX-HUFAEIL \$295	<input type="checkbox"/> LINX-HUFAEIL \$295	<input type="checkbox"/> LINX2-HUFAEIL \$330				
	Swing-Away Arms*	Large	<input type="checkbox"/> AXYS-HUSALL \$355	<input type="checkbox"/> ONYX-HUSALL \$355	<input type="checkbox"/> LINX-HUSALL \$355	<input type="checkbox"/> LINX2-HUSALL \$390			
			<input type="checkbox"/> AXYS-HUSALV \$355	<input type="checkbox"/> ONYX-HUSALV \$355	<input type="checkbox"/> LINX-HUSALV \$355	<input type="checkbox"/> LINX2-HUSALV \$390			
		Medium	<input type="checkbox"/> AXYS-HUSAML \$355	<input type="checkbox"/> ONYX-HUSAML \$355	<input type="checkbox"/> LINX-HUSAML \$355	<input type="checkbox"/> LINX2-HUSAML \$390			
			<input type="checkbox"/> AXYS-HUSAMV \$355	<input type="checkbox"/> ONYX-HUSAMV \$355	<input type="checkbox"/> LINX-HUSAMV \$355	<input type="checkbox"/> LINX2-HUSAMV \$390			
		Small	<input type="checkbox"/> AXYS-HUSASL \$355	<input type="checkbox"/> ONYX-HUSASL \$355	<input type="checkbox"/> LINX-HUSASL \$355	<input type="checkbox"/> LINX2-HUSASL \$390			
<input type="checkbox"/> AXYS-HUSASV \$355			<input type="checkbox"/> ONYX-HUSASV \$355	<input type="checkbox"/> LINX-HUSASV \$355	<input type="checkbox"/> LINX2-HUSASV \$390				
Early Intervention	<input type="checkbox"/> AXYS-HUSAEIL \$355	<input type="checkbox"/> ONYX-HUSAEIL \$355	<input type="checkbox"/> LINX-HUSAEIL \$355	<input type="checkbox"/> LINX2-HUSAEIL \$390					
		<input type="checkbox"/> AXYS-HUSAEIV \$355	<input type="checkbox"/> ONYX-HUSAEIV \$355	<input type="checkbox"/> LINX-HUSAEIV \$355	<input type="checkbox"/> LINX2-HUSAEIV \$390				

Head Positioning - Use HCPCS Code E0955

Whitmyer headrests come unassembled. Please add item WHITASSY001 if the dealer would like parts assembled. This is a no charge option.

	<input type="checkbox"/> Receiver must be selected on pg 2		<input type="checkbox"/> Adult - 15" <input type="checkbox"/> Peds - 11" <input type="checkbox"/> EI - 10"		<input type="checkbox"/> Adult - 15" <input type="checkbox"/> Peds - 11" <input type="checkbox"/> EI - 10"
---	--	--	--	---	--

PAD		PRO		COBRA		COBRA-FB	
HEADS UP - COMMON SIZES	Fixed Arm	Large	<input type="checkbox"/> PRO-HUFALL \$330	<input type="checkbox"/> COBRA-HUFALL \$530	<input type="checkbox"/> FBCOB-HUFALL \$630		
			<input type="checkbox"/> PRO-HUFALV \$330	<input type="checkbox"/> COBRA-HUFALV \$530	<input type="checkbox"/> FBCOB-HUFALV \$630		
		Medium	<input type="checkbox"/> PRO-HUFAML \$330	<input type="checkbox"/> COBRA-HUFAML \$530	<input type="checkbox"/> FBCOB-HUFAML \$630		
			<input type="checkbox"/> PRO-HUFAMV \$330	<input type="checkbox"/> COBRA-HUFAMV \$530	<input type="checkbox"/> FBCOB-HUFAMV \$630		
		Small	<input type="checkbox"/> PRO-HUFASL \$330	<input type="checkbox"/> COBRA-HUFASL \$530	<input type="checkbox"/> FBCOB-HUFASL \$630		
			<input type="checkbox"/> PRO-HUFASV \$330	<input type="checkbox"/> COBRA-HUFASV \$530	<input type="checkbox"/> FBCOB-HUFASV \$630		
	Early Intervention	<input type="checkbox"/> PRO-HUFAEIL \$330	<input type="checkbox"/> COBRA-HUFAEIL \$530	<input type="checkbox"/> FBCOB-HUFAEIL \$630			
	Swing-Away Arms*	Large	<input type="checkbox"/> PRO-HUSALL \$400	<input type="checkbox"/> COBRA-HUSALL \$600	<input type="checkbox"/> FBCOB-HUSALL \$700		
			<input type="checkbox"/> PRO-HUSALV \$400	<input type="checkbox"/> COBRA-HUSALV \$600	<input type="checkbox"/> FBCOB-HUSALV \$700		
		Medium	<input type="checkbox"/> PRO-HUSAML \$400	<input type="checkbox"/> COBRA-HUSAML \$600	<input type="checkbox"/> FBCOB-HUSAML \$700		
			<input type="checkbox"/> PRO-HUSAMV \$400	<input type="checkbox"/> COBRA-HUSAMV \$600	<input type="checkbox"/> FBCOB-HUSAMV \$700		
		Small	<input type="checkbox"/> PRO-HUSASL \$400	<input type="checkbox"/> COBRA-HUSASL \$600	<input type="checkbox"/> FBCOB-HUSASL \$700		
<input type="checkbox"/> PRO-HUSASV \$400			<input type="checkbox"/> COBRA-HUSASV \$600	<input type="checkbox"/> FBCOB-HUSASV \$700			
Early Intervention	<input type="checkbox"/> PRO-HUSAEIL \$400	<input type="checkbox"/> COBRA-HUSAEIL \$600	<input type="checkbox"/> FBCOB-HUSAEIL \$700				
		<input type="checkbox"/> PRO-HUSAEIV \$400	<input type="checkbox"/> COBRA-HUSAEIV \$600	<input type="checkbox"/> FBCOB-HUSAEIV \$700			





*See Page 3 for all custom configurations available

Customer Service: 800-333-4000 Fax: 800-300-7502 Email: orders@sunmed.com www.sunrisemedical.com

©4/2020 MK-129444 REV. E

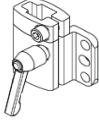
Mounting Brackets - Use HCPCS Code E1028



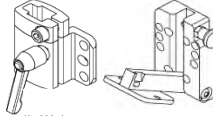
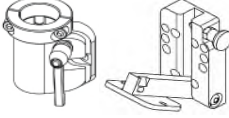
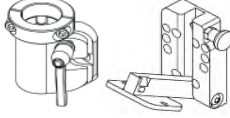
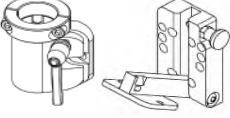

Head Support System Mounting Brackets must be ordered separately, except for COBRA

	AXYS	ONYX	LINX & LINX ²	PRO	COBRA mounting system includes detachable mounting bracket	
REMOVABLE MOUNTING BRACKET (PART SOLD SEPARATELY FROM POST & PAD)						
Detachable	<input type="checkbox"/> M2500 \$105	<input type="checkbox"/> M2100-WB \$85	<input type="checkbox"/> M2300 \$165	<input type="checkbox"/> M2200-WB \$185		
REMOVABLE & SWING-AWAY MNT BRACKET (PART SOLD SEPARATELY FROM POST & PAD)						
Swing-Away	<input type="checkbox"/> M5500 \$200	<input type="checkbox"/> M5100 \$185	<input type="checkbox"/> M5300 \$265	<input type="checkbox"/> M5200 \$285		

HEADS UP - HEAD AND NECK POSITIONING SYSTEM ORDERING GUIDE

Head Support System Mounting Brackets must be ordered separately, except for COBRA

STEP 1: SELECT HARDWARE SYSTEM

							
	<input type="checkbox"/> AXYS-HU-	<input type="checkbox"/> ONYX-HU-	<input type="checkbox"/> LINX-HU-	<input type="checkbox"/> LINX2-HU-	<input type="checkbox"/> PRO-HU-	<input type="checkbox"/> COBRA-HU-	<input type="checkbox"/> FBCOB-HU-
W/O OCC Pad	\$355	\$355	\$355	\$390	\$400	\$600	\$700
W/ OCC Pad	\$455	\$455	\$455	\$490	\$500	\$700	\$800

BUILD YOUR HEADS UP SMART PART NUMBER

STEP 1 Enter Hardware System Part Number	
STEP 2 Enter I, S, M, or L	
STEP 3 Enter T or S	
STEP 4 Enter S or L	
STEP 5 Enter S or C	
STEP 6 Enter L or V	
STEP 7 (Optional) Enter -O5, -O6, -O8, or -O10	

STEP 2: SELECT NECK WIDTH

<input type="checkbox"/> I = Infant 3.3" wide
<input type="checkbox"/> S = Small 4" wide
<input type="checkbox"/> M = Medium 4.6" wide
<input type="checkbox"/> L = Large 5.8" wide

STEP 4: SELECT SWING OUT SUPPORT ARM LENGTH

<input type="checkbox"/> S = Short
<input type="checkbox"/> L = Long
<i>Infant & Small: Short = 5.63" Long = 7.25"</i>
<i>Medium & Large: Short = 7" Long = 9"</i>

STEP 5: SELECT FOAM TYPE

<input type="checkbox"/> S = Standard
<input type="checkbox"/> C = Comfort

STEP 6: SELECT COVER









<input type="checkbox"/> L = Lycra Neoprene
<input type="checkbox"/> V = Dartex Reversed

STEP 3: SELECT CONTOUR CRADLE HEIGHT

	Tall	Short shown with Occipital Pad (Step 7)
<input type="checkbox"/> T = Tall		
<input type="checkbox"/> S = Short		

STEP 7: SELECT OPTIONAL OCC PADS

<i>Available on Short Heights Only</i>	
<input type="checkbox"/> -O5 = Pediatric 5" Pad (Short Infant Sizes)	
<input type="checkbox"/> -O6 = Adult 6" Pad (Short Small Sizes)	
<input type="checkbox"/> -O8 = Plush 8" Pad (Short Medium Sizes)	
<input type="checkbox"/> -O10 = Plush 10" Pad (Short Large Sizes)	
<input type="checkbox"/> N/A	

Lateral Facial Supports								
Note: Cover Selection - Add L = Lycra or V = Dartex Reversed (Example: LFC-PL L)								
								
SPOT	STANDARD	LONG	OVAL	LARGE-C	MED-C	SMALL-C	FSO-B	

Unilateral	<input type="checkbox"/>	LFC10-CSL \$220 LM115 \$80	<input type="checkbox"/>	LFC15-CSL \$220 LM115 \$80	<input type="checkbox"/>	LFC20-CSL \$220 LM115 \$80	<input type="checkbox"/>	LFC25-CSL \$220 LM115 \$80	<input type="checkbox"/>	LFC30-CSL \$220 LM115 \$80	<input type="checkbox"/>	LFC35-CSL \$220 LM115 \$80	<input type="checkbox"/>	LFC40-CSL \$220 LM115 \$80	<input type="checkbox"/>	LFC80-CS \$255 LM115 \$80
	<input type="checkbox"/>	LFC10-CSV \$220 LM115 \$80	<input type="checkbox"/>	LFC15-CSV \$220 LM115 \$80	<input type="checkbox"/>	LFC20-CSV \$220 LM115 \$80	<input type="checkbox"/>	LFC25-CSV \$220 LM115 \$80	<input type="checkbox"/>	LFC30-CSV \$220 LM115 \$80	<input type="checkbox"/>	LFC35-CSV \$220 LM115 \$80	<input type="checkbox"/>	LFC40-CSV \$220 LM115 \$80		

Bilateral	<input type="checkbox"/>	LFC10-CS2L \$410 LM115 \$80 LM115 \$80	<input type="checkbox"/>	LFC15-CS2L \$410 LM115 \$80 LM115 \$80	<input type="checkbox"/>	LFC20-CS2L \$410 LM115 \$80 LM115 \$80	<input type="checkbox"/>	LFC25-CS2L \$410 LM115 \$80 LM115 \$80	<input type="checkbox"/>	LFC30-CS2L \$410 LM115 \$80 LM115 \$80	<input type="checkbox"/>	LFC35-CS2L \$410 LM115 \$80 LM115 \$80	<input type="checkbox"/>	LFC40-CS2L \$410 LM115 \$80 LM115 \$80	<input type="checkbox"/>	LFC80-CS2 \$469 LM115 \$80 LM115 \$80
	<input type="checkbox"/>	LFC10-CS2V \$410 LM115 \$80 LM115 \$80	<input type="checkbox"/>	LFC15-CS2V \$410 LM115 \$80 LM115 \$80	<input type="checkbox"/>	LFC20-CS2V \$410 LM115 \$80 LM115 \$80	<input type="checkbox"/>	LFC25-CS2V \$410 LM115 \$80 LM115 \$80	<input type="checkbox"/>	LFC30-CS2V \$410 LM115 \$80 LM115 \$80	<input type="checkbox"/>	LFC35-CS2V \$410 LM115 \$80 LM115 \$80	<input type="checkbox"/>	LFC40-CS2V \$410 LM115 \$80 LM115 \$80		

Pad Only*	<input type="checkbox"/>	PL10L \$70	<input type="checkbox"/>	PL15L \$100	<input type="checkbox"/>	PL20L \$100	<input type="checkbox"/>	P600L \$100	<input type="checkbox"/>	PL30L \$100	<input type="checkbox"/>	PL35L \$100	<input type="checkbox"/>	PL40L \$90	<input type="checkbox"/>	N/A
	<input type="checkbox"/>	PL10V \$70	<input type="checkbox"/>	PL15V \$100	<input type="checkbox"/>	PL20V \$100	<input type="checkbox"/>	P600V \$100	<input type="checkbox"/>	PL30V \$100	<input type="checkbox"/>	PL35V \$100	<input type="checkbox"/>	PL40V \$90		

ADDITIONAL LATERAL FACIAL SUPPORT PARTS

*Note: If ordering an additional Lateral Facial Support, select both a Lateral Facial Support Pad Only from page 3 and an Infinity Mount from below as well



<input checked="" type="checkbox"/>	Option #	Definition	Price
<input type="checkbox"/>	242161	Infinity Dual Mount Assembly*	\$195
<input type="checkbox"/>	LM1010	Lateral Facial Support*	\$125

ANTERIOR HEAD SUPPORT

			
DYNAMIC FOREHEAD STRAP	DFS ²	STRAP CAP	STATIC FOREHEAD STRAP

ADULT	<input type="checkbox"/>	DFS10	\$289	<input type="checkbox"/>	DFSQ10	\$349	<input type="checkbox"/>	CAP10 (black)	\$400	<input type="checkbox"/>	HU10	\$315
PEDS	<input type="checkbox"/>	DFS30	\$289	<input type="checkbox"/>	DFSQ30	\$349	<input type="checkbox"/>	CAP30-R (red)	\$400			
	<input type="checkbox"/>			<input type="checkbox"/>			<input type="checkbox"/>	CAP30-B (blue)	\$400			

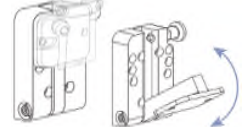
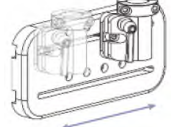
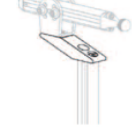
CUSTOM MOUNTING OPTIONS

														
FLEX INTERFACE BRACKET	UNIVERSAL SWING-AWAY MOUNT	SLIDE MOUNT	PRO OFF-SET MOUNTING SYSTEM	ONYX REARWARD OFF-SET VERTICAL ROD										
<input type="checkbox"/>	M9450 (hard)	\$185	<input type="checkbox"/>	M5000	\$100	<input type="checkbox"/>	M7010	\$95	<input type="checkbox"/>	PRC7070	\$163	<input type="checkbox"/>	OX6030	\$60
<input type="checkbox"/>	M9451 (soft)	\$185												



TOOLS

✓	Option #	Definition	Price
<input type="checkbox"/>	BOLT LUBE	Bolt Lube	\$0
<input type="checkbox"/>	T2500	Tool Kit	\$3.33

Pad Styles

HEADS UP COMMON SIZES	Large HU-L		Medium HU-M		Small HU-S		Early Intervention HU-I								
					5.8" Neck Width	4.6" Neck Width	4" Neck Width	3.3" Neck Width	9" Long Arms	9" Long Arms	5.6" Short Arms	5.6" Short Arms	Standard Foam	Standard Foam	Standard Foam

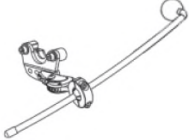
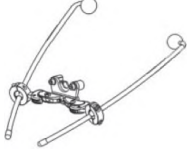
Lateral Facial Supports

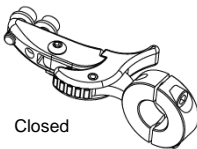
MOUNTING HARDWARE	Unilateral		Bilateral		Infinity Mount		Swing-Away Mount	
						Open	Closed	LM115

CUSTOM MOUNTS

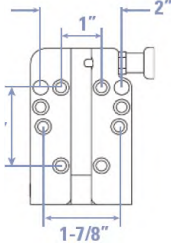
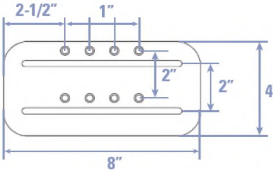
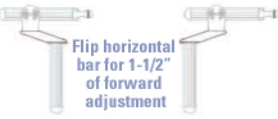
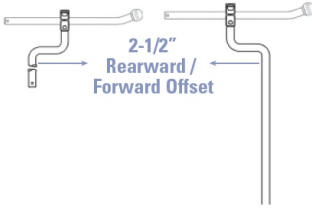
			
UNIVERSAL SWING- AWAY MOUNT	SLIDE MOUNT	PRO OFF-SET MOUNTING SYSTEM	ONYX REARWARD OFF- SET VERTICAL ROD



Sunrise Medical (US) LLC
2842 Business Park Ave. · Fresno, CA 93727 · USA