

Mark For: _____

Submitting for: Quote Order

Date: _____

PO#: _____

Dealer Acct #: _____

Dealer: _____

Dealer Contact: _____

Dealer Address: _____

Dealer City: _____ ST: _____ ZIP: _____

Dealer Phone: () _____ Fax: () _____

Confirmation Email: _____

Confirm Via: Fax Email

ADDITIONAL SHIPPING INFORMATION

Ship To: _____

Attention: _____

Address: _____

Address: _____

Ship To City: _____ ST: _____ ZIP: _____





Ship To Phone: () _____ Fax: () _____

The **HCPCS CODES** herein are based on PDAC verification or interpretation of Medicare definitions and guidelines. Non-Medicare payers may accept alternative **HCPCS CODES**, including misc. codes to ensure access for their enrollees. The use of **HCPCS CODES** does not ensure coverage or payment.

Head Positioning - Use HCPCS Code E0955

Whitmyer headrests come unassembled. Please add item WHITASSY001 if the dealer would like parts assembled. This is a no charge option.

Note: For cover selection, **L** = Lycra and **V** = Dartex Reversed (Example: AXYS-HUFALL or AXYS-HUFALV)

		<input type="checkbox"/> Receiver must be selected on pg 2		<input type="checkbox"/> Receiver must be selected on pg 2		<input type="checkbox"/> Receiver must be selected on pg 2		<input type="checkbox"/> Receiver must be selected on pg 2		<input type="checkbox"/> Receiver must be selected on pg 2
		PAD	AXYS	ONYX	LINX			LINX²		
HEADS UP - COMMON SIZES	Fixed Arm	Large	<input type="checkbox"/> AXYS-HUFALL \$300	<input type="checkbox"/> ONYX-HUFALL \$300	<input type="checkbox"/> LINX-HUFALL \$300	<input type="checkbox"/> LINX2-HUFALL \$337				
		Medium	<input type="checkbox"/> AXYS-HUFALV \$300	<input type="checkbox"/> ONYX-HUFALV \$300	<input type="checkbox"/> LINX-HUFALV \$300	<input type="checkbox"/> LINX2-HUFALV \$337				
		Small	<input type="checkbox"/> AXYS-HUFAML \$300	<input type="checkbox"/> ONYX-HUFAML \$300	<input type="checkbox"/> LINX-HUFAML \$300	<input type="checkbox"/> LINX2-HUFAML \$337				
		Early Intervention	<input type="checkbox"/> AXYS-HUFAMV \$300	<input type="checkbox"/> ONYX-HUFAMV \$300	<input type="checkbox"/> LINX-HUFAMV \$300	<input type="checkbox"/> LINX2-HUFAMV \$337				
	Swing-Away Arms*	Large	<input type="checkbox"/> AXYS-HUFASL \$300	<input type="checkbox"/> ONYX-HUFASL \$300	<input type="checkbox"/> LINX-HUFASL \$300	<input type="checkbox"/> LINX2-HUFASL \$337				
		Medium	<input type="checkbox"/> AXYS-HUFASV \$300	<input type="checkbox"/> ONYX-HUFASV \$300	<input type="checkbox"/> LINX-HUFASV \$300	<input type="checkbox"/> LINX2-HUFASV \$337				
		Small	<input type="checkbox"/> AXYS-HUFAEIL \$300	<input type="checkbox"/> ONYX-HUFAEIL \$300	<input type="checkbox"/> LINX-HUFAEIL \$300	<input type="checkbox"/> LINX2-HUFAEIL \$337				
		Early Intervention	<input type="checkbox"/> AXYS-HUFAEIV \$300	<input type="checkbox"/> ONYX-HUFAEIV \$300	<input type="checkbox"/> LINX-HUFAEIV \$300	<input type="checkbox"/> LINX2-HUFAEIV \$337				
		Large	<input type="checkbox"/> AXYS-HUSALL \$362	<input type="checkbox"/> ONYX-HUSALL \$362	<input type="checkbox"/> LINX-HUSALL \$362	<input type="checkbox"/> LINX2-HUSALL \$398				
		Medium	<input type="checkbox"/> AXYS-HUSALV \$362	<input type="checkbox"/> ONYX-HUSALV \$362	<input type="checkbox"/> LINX-HUSALV \$362	<input type="checkbox"/> LINX2-HUSALV \$398				
		Small	<input type="checkbox"/> AXYS-HUSAML \$362	<input type="checkbox"/> ONYX-HUSAML \$362	<input type="checkbox"/> LINX-HUSAML \$362	<input type="checkbox"/> LINX2-HUSAML \$398				
		Early Intervention	<input type="checkbox"/> AXYS-HUSAMV \$362	<input type="checkbox"/> ONYX-HUSAMV \$362	<input type="checkbox"/> LINX-HUSAMV \$362	<input type="checkbox"/> LINX2-HUSAMV \$398				
Large	<input type="checkbox"/> AXYS-HUSASL \$362	<input type="checkbox"/> ONYX-HUSASL \$362	<input type="checkbox"/> LINX-HUSASL \$362	<input type="checkbox"/> LINX2-HUSASL \$398						
Medium	<input type="checkbox"/> AXYS-HUSASV \$362	<input type="checkbox"/> ONYX-HUSASV \$362	<input type="checkbox"/> LINX-HUSASV \$362	<input type="checkbox"/> LINX2-HUSASV \$398						
Small	<input type="checkbox"/> AXYS-HUSAEIL \$362	<input type="checkbox"/> ONYX-HUSAEIL \$362	<input type="checkbox"/> LINX-HUSAEIL \$362	<input type="checkbox"/> LINX2-HUSAEIL \$398						
Early Intervention	<input type="checkbox"/> AXYS-HUSAEIV \$362	<input type="checkbox"/> ONYX-HUSAEIV \$362	<input type="checkbox"/> LINX-HUSAEIV \$362	<input type="checkbox"/> LINX2-HUSAEIV \$398						

Head Positioning - Use HCPCS Code E0955







Whitmyer headrests come unassembled. Please add item WHITASSY001 if the dealer would like parts assembled. This is a no charge option.

		<input type="checkbox"/> Receiver must be selected on pg 2		<input type="checkbox"/> Adult - 15" <input type="checkbox"/> Peds - 11" <input type="checkbox"/> EI - 10"		<input type="checkbox"/> Adult - 15" <input type="checkbox"/> Peds - 11" <input type="checkbox"/> EI - 10"		<input type="checkbox"/> Adult - 15" <input type="checkbox"/> Peds - 11" <input type="checkbox"/> EI - 10"
		PAD	PRO	COBRA			COBRA-FB	
HEADS UP - COMMON SIZES	Fixed Arm	Large	<input type="checkbox"/> PRO-HUFALL \$337	<input type="checkbox"/> COBRA-HUFALL \$540	<input type="checkbox"/> FBCOB-HUFALL \$643			
		Medium	<input type="checkbox"/> PRO-HUFALV \$337	<input type="checkbox"/> COBRA-HUFALV \$540	<input type="checkbox"/> FBCOB-HUFALV \$643			
		Small	<input type="checkbox"/> PRO-HUFAML \$337	<input type="checkbox"/> COBRA-HUFAML \$540	<input type="checkbox"/> FBCOB-HUFAML \$643			
		Early Intervention	<input type="checkbox"/> PRO-HUFAMV \$337	<input type="checkbox"/> COBRA-HUFAMV \$540	<input type="checkbox"/> FBCOB-HUFAMV \$643			
	Swing-Away Arms*	Large	<input type="checkbox"/> PRO-HUFASL \$337	<input type="checkbox"/> COBRA-HUFASL \$540	<input type="checkbox"/> FBCOB-HUFASL \$643			
		Medium	<input type="checkbox"/> PRO-HUFASV \$337	<input type="checkbox"/> COBRA-HUFASV \$540	<input type="checkbox"/> FBCOB-HUFASV \$643			
		Small	<input type="checkbox"/> PRO-HUFAEIL \$337	<input type="checkbox"/> COBRA-HUFAEIL \$540	<input type="checkbox"/> FBCOB-HUFAEIL \$643			
		Early Intervention	<input type="checkbox"/> PRO-HUFAEIV \$337	<input type="checkbox"/> COBRA-HUFAEIV \$540	<input type="checkbox"/> FBCOB-HUFAEIV \$643			
		Large	<input type="checkbox"/> PRO-HUSALL \$408	<input type="checkbox"/> COBRA-HUSALL \$612	<input type="checkbox"/> FBCOB-HUSALL \$714			
		Medium	<input type="checkbox"/> PRO-HUSALV \$408	<input type="checkbox"/> COBRA-HUSALV \$612	<input type="checkbox"/> FBCOB-HUSALV \$714			
		Small	<input type="checkbox"/> PRO-HUSAML \$408	<input type="checkbox"/> COBRA-HUSAML \$612	<input type="checkbox"/> FBCOB-HUSAML \$714			
		Early Intervention	<input type="checkbox"/> PRO-HUSAMV \$408	<input type="checkbox"/> COBRA-HUSAMV \$612	<input type="checkbox"/> FBCOB-HUSAMV \$714			
Large	<input type="checkbox"/> PRO-HUSASL \$408	<input type="checkbox"/> COBRA-HUSASL \$612	<input type="checkbox"/> FBCOB-HUSASL \$714					
Medium	<input type="checkbox"/> PRO-HUSASV \$408	<input type="checkbox"/> COBRA-HUSASV \$612	<input type="checkbox"/> FBCOB-HUSASV \$714					
Small	<input type="checkbox"/> PRO-HUSAEIL \$408	<input type="checkbox"/> COBRA-HUSAEIL \$612	<input type="checkbox"/> FBCOB-HUSAEIL \$714					
Early Intervention	<input type="checkbox"/> PRO-HUSAEIV \$408	<input type="checkbox"/> COBRA-HUSAEIV \$612	<input type="checkbox"/> FBCOB-HUSAEIV \$714					

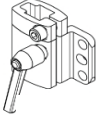
*See Page 2 for all configurations available

Mounting Brackets - Use HCPCS Code E1028

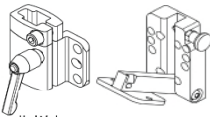

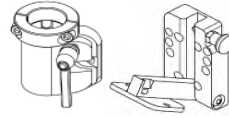
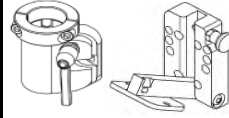



Head Support System Mounting Brackets must be ordered separately, except for COBRA

	AXYS	ONYX	LINX & LINX ²	PRO	COBRA mounting system includes detachable mounting bracket
REMOVABLE MOUNTING BRACKET (PART SOLD SEPARATELY FROM POST & PAD)					
Detachable	<input type="checkbox"/> M2500 \$107	<input type="checkbox"/> M2100-WB \$87	<input type="checkbox"/> M2300 \$168	<input type="checkbox"/> M2200-WB \$189	
REMOVABLE & SWING-AWAY MNT BRACKET (PART SOLD SEPARATELY FROM POST & PAD)					
Swing-Away	<input type="checkbox"/> M5500 \$204	<input type="checkbox"/> M5100 \$189	<input type="checkbox"/> M5300 \$270	<input type="checkbox"/> M5200 \$290	

HEADS UP - HEAD AND NECK POSITIONING SYSTEM ORDERING GUIDE

Head Support System Mounting Brackets must be ordered separately, except for COBRA

STEP 1: SELECT HARDWARE SYSTEM

							
	<input type="checkbox"/> AXYS-HU-	<input type="checkbox"/> ONYX-HU-	<input type="checkbox"/> LINX-HU-	<input type="checkbox"/> LINX2-HU-	<input type="checkbox"/> PRO-HU-	<input type="checkbox"/> COBRA-HU-	<input type="checkbox"/> FBCOB-HU-
W/O OCC Pad	\$362	\$362	\$362	\$398	\$408	\$612	\$714
W/ OCC Pad	\$464	\$464	\$464	\$500	\$510	\$714	\$816

BUILD YOUR HEADS UP SMART PART NUMBER

STEP 1 Enter Hardware System Part Number	
STEP 2 Enter I, S, M, or L	
STEP 3 Enter T or S	
STEP 4 Enter S or L	
STEP 5 Enter S or C	
STEP 6 Enter L or V	
STEP 7 (Optional) Enter -O5, -O6, -O8, or -O10	

STEP 2: SELECT NECK WIDTH



- I = Infant 3.3" wide
- S = Small 4" wide
- M = Medium 4.6" wide
- L = Large 5.8" wide

STEP 4: SELECT SWING OUT SUPPORT ARM LENGTH



- S = Short
 - L = Long
- Infant & Small: Short = 5.63" Long = 7.25"*
Medium & Large: Short = 7" Long = 9"

STEP 5: SELECT FOAM TYPE

- S = Standard
- C = Comfort

STEP 6: SELECT COVER

- L = Lycra Neoprene
- V = Dartex Reversed

STEP 3: SELECT CONTOUR CRADLE HEIGHT



- T = Tall
- S = Short









STEP 7: SELECT OPTIONAL OCC PADS

Available on Short Heights Only

- O5 = Pediatric 5" Pad (Short Infant Sizes)
- O6 = Adult 6" Pad (Short Small Sizes)
- O8 = Plush 8" Pad (Short Medium Sizes)
- O10 = Plush 10" Pad (Short Large Sizes)
- N/A

Lateral Facial Supports

Note: Cover Selection - Add L = Lycra or V = Dartex Reversed (Example: LFC-PLL)



	 2"	 2.25" x 5"	 2.25" x 7"	 4" x 6"	 2" x 6"	 1.75" x 5"	 1.25" x 4"	
	SPOT	STANDARD	LONG	OVAL	LARGE-C	MED-C	SMALL-C	FSO-B

Unilateral	<input type="checkbox"/>	LFC10-CSL \$224	<input type="checkbox"/>	LFC15-CSL \$224	<input type="checkbox"/>	LFC20-CSL \$224	<input type="checkbox"/>	LFC25-CSL \$224	<input type="checkbox"/>	LFC30-CSL \$224	<input type="checkbox"/>	LFC35-CSL \$224	<input type="checkbox"/>	LFC40-CSL \$224	<input type="checkbox"/>	LFC80-CS \$260 LM115 \$82
		LM115 \$82		LM115 \$82		LM115 \$82		LM115 \$82		LM115 \$82		LM115 \$82		LM115 \$82		
	<input type="checkbox"/>	LFC10-CSV \$224	LFC15-CSV \$224	LFC20-CSV \$224	LFC25-CSV \$224	LFC30-CSV \$224	LFC35-CSV \$224	LFC40-CSV \$224								
		LM115 \$82	LM115 \$82	LM115 \$82	LM115 \$82	LM115 \$82	LM115 \$82	LM115 \$82								

Bilateral	<input type="checkbox"/>	LFC10-CS2L \$418	<input type="checkbox"/>	LFC15-CS2L \$418	<input type="checkbox"/>	LFC20-CS2L \$418	<input type="checkbox"/>	LFC25-CS2L \$418	<input type="checkbox"/>	LFC30-CS2L \$418	<input type="checkbox"/>	LFC35-CS2L \$418	<input type="checkbox"/>	LFC40-CS2L \$418	<input type="checkbox"/>	LFC80-CS2 \$478 LM115 \$82 LM115 \$82
		LM115 \$82		LM115 \$82		LM115 \$82		LM115 \$82		LM115 \$82		LM115 \$82		LM115 \$82		
		LM115 \$82		LM115 \$82		LM115 \$82		LM115 \$82		LM115 \$82		LM115 \$82		LM115 \$82		
	<input type="checkbox"/>	LFC10-CS2V \$418	LFC15-CS2V \$418	LFC20-CS2V \$418	LFC25-CS2V \$418	LFC30-CS2V \$418	LFC35-CS2V \$418	LFC40-CS2V \$418								
		LM115 \$82	LM115 \$82	LM115 \$82	LM115 \$82	LM115 \$82	LM115 \$82	LM115 \$82								
		LM115 \$82	LM115 \$82	LM115 \$82	LM115 \$82	LM115 \$82	LM115 \$82	LM115 \$82								

Pad Only*	<input type="checkbox"/>	PL10L \$72	<input type="checkbox"/>	PL15L \$102	<input type="checkbox"/>	PL20L \$102	<input type="checkbox"/>	P600L \$102	<input type="checkbox"/>	PL30L \$102	<input type="checkbox"/>	PL35L \$102	<input type="checkbox"/>	PL40L \$92	N/A
		PL10V \$72		PL15V \$102		PL20V \$102		P600V \$102		PL30V \$102		PL35V \$102		PL40V \$92	

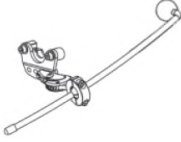
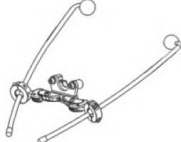
Lateral Facial Supports

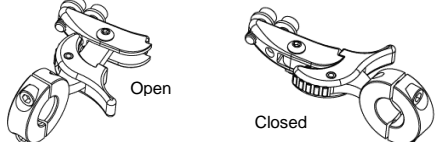

MOUNTING HARDWARE	 Unilateral	 Bilateral	 Infinity Mount	 Swing-Away Mount LM115
				Open Closed

LATERAL FACIAL SUPPORT PARTS

*Note: If ordering an additional Lateral Facial Support, select both a Lateral Facial Support Pad Only from page 3 and an Infinity Mount from below as well

	Option #	Definition	Price
<input type="checkbox"/>	242161	Infinity Dual Mount Assembly*	\$199
<input type="checkbox"/>	LM1010	Lateral Facial Support*	\$128

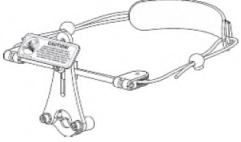
ANTERIOR HEAD SUPPORT

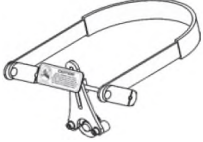
 DYNAMIC FOREHEAD STRAP	 DFS²	 STRAP CAP	 STATIC FOREHEAD STRAP						
ADULT	<input type="checkbox"/>	DFS10 \$295	<input type="checkbox"/>	DFSQ10 \$356	<input type="checkbox"/>	CAP10 (black) \$408	<input type="checkbox"/>	HU10	\$321
PEDS	<input type="checkbox"/>	DFS30 \$295	<input type="checkbox"/>	DFSQ30 \$356	<input type="checkbox"/>	CAP30-R (red) \$408 CAP30-B (blue) \$408			

MOUNTING OPTIONS

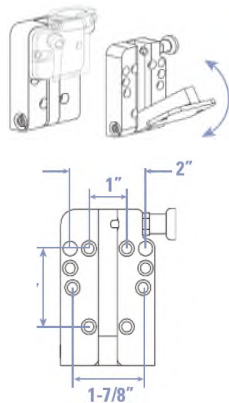
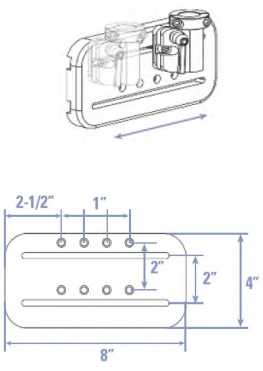
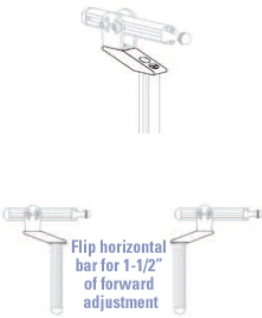
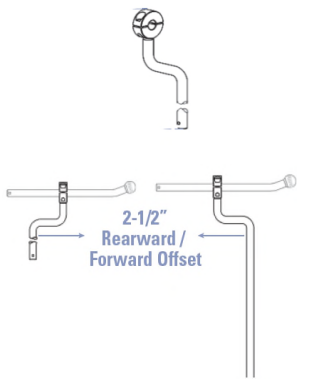
				
<p>FLEX INTERFACE BRACKET</p>	<p>UNIVERSAL SWING-AWAY MOUNT</p>	<p>SLIDE MOUNT</p>	<p>PRO OFF-SET MOUNTING SYSTEM</p>	<p>ONYX REARWARD OFF-SET VERTICAL ROD</p>

<input type="checkbox"/>	M9450 (hard)	\$189	<input type="checkbox"/>	M5000	\$102	<input type="checkbox"/>	M7010	\$97	<input type="checkbox"/>	PRC7070	\$166	<input type="checkbox"/>	OX6030	\$62
<input type="checkbox"/>	M9451 (soft)	\$189												

TOOLS

✓	Option #	Definition	Price
<input type="checkbox"/>	BOLT LUBE	Bolt Lube	\$7.00
<input type="checkbox"/>	T2500	Tool Kit	\$5.00

Pad Styles

<p>HEADS UP COMMON SIZES</p>	 <p>Large HU-L 5.8" Neck Width 9" Long Arms Standard Foam</p>	 <p>Medium HU-M 4.6" Neck Width 9" Long Arms Standard Foam</p>	 <p>Small HU-S 4" Neck Width 5.6" Short Arms Standard Foam</p>	 <p>Early Intervention HU-I 3.3" Neck Width 5.6" Short Arms Standard Foam</p>
-------------------------------------	---	--	--	---



SUNRISE MEDICAL.

Sunrise Medical (US) LLC
2842 Business Park Ave. · Fresno, CA 93727 · USA