

Mark For:

Submitting for:

Quote Order

Date: _____

PO#: _____

Dealer Acct #: _____

Dealer: _____

ADDITIONAL SHIPPING INFORMATION

Dealer Contact: _____

Ship To: _____

Dealer Address: _____

Attention: _____

Dealer City: _____ ST: _____ ZIP: _____

Address: _____

Dealer Phone: () _____ Fax: () _____

Address: _____

Confirmation Email: _____

Ship To City: _____ ST: _____ ZIP: _____

Confirm Via: Fax Email

Ship To Phone: () _____ Fax: () _____

The **HCPCS CODES** provided are based on code verification through PDAC or our interpretation of the code definitions.

The use of **HCPCS CODES** does not ensure coverage or payment. For coverage information, verify the appropriate payer's coverage policy.

Note: For cover selection, **L** = Lycra and **V** = Dartex Reversed

Head Positioning - Use HCPCS Code E0955

Whitmyer headrests come unassembled. Please add item WHITASSY001 if the dealer would like parts assembled. This is a no charge option.

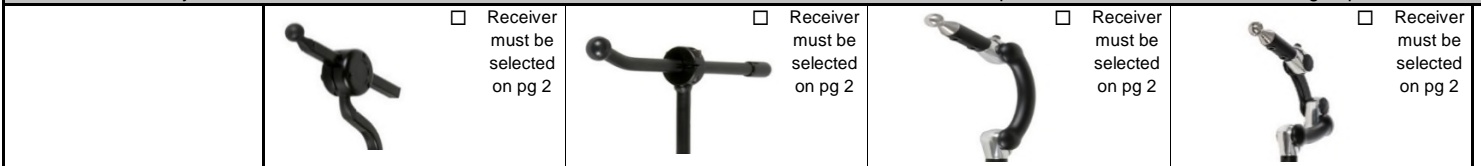

PAD	AXYS	ONYX	LINX	LINX²
------------	-------------	-------------	-------------	-------------------------

SINGLE SUB-OCCIPITAL	10" Pad Lrg OCC
	6" Pad Lrg OCC
	6" Pad Sml OCC
	5" Pad Sml OCC

<input type="checkbox"/>	AXYS-SS10L	\$370	<input type="checkbox"/>	ONYX-SS10L	\$370	<input type="checkbox"/>	LINX-SS10L	\$395	<input type="checkbox"/>	LINX2-SS10L	\$430
<input type="checkbox"/>	AXYS-SS10V	\$370	<input type="checkbox"/>	ONYX-SS10V	\$370	<input type="checkbox"/>	LINX-SS10V	\$395	<input type="checkbox"/>	LINX2-SS10V	\$430
<input type="checkbox"/>	AXYS-SS8L	\$345	<input type="checkbox"/>	ONYX-SS8L	\$345	<input type="checkbox"/>	LINX-SS8L	\$375	<input type="checkbox"/>	LINX2-SS8L	\$410
<input type="checkbox"/>	AXYS-SS8V	\$345	<input type="checkbox"/>	ONYX-SS8V	\$345	<input type="checkbox"/>	LINX-SS8V	\$375	<input type="checkbox"/>	LINX2-SS8V	\$410
<input type="checkbox"/>	AXYS-SS4L	\$315	<input type="checkbox"/>	ONYX-SS4L	\$315	<input type="checkbox"/>	LINX-SS4L	\$345	<input type="checkbox"/>	LINX2-SS4L	\$380
<input type="checkbox"/>	AXYS-SS4V	\$315	<input type="checkbox"/>	ONYX-SS4V	\$315	<input type="checkbox"/>	LINX-SS4V	\$345	<input type="checkbox"/>	LINX2-SS4V	\$380
<input type="checkbox"/>	AXYS-SS3L	\$315	<input type="checkbox"/>	ONYX-SS3L	\$315	<input type="checkbox"/>	LINX-SS3L	\$345	<input type="checkbox"/>	LINX2-SS3L	\$380
<input type="checkbox"/>	AXYS-SS3V	\$315	<input type="checkbox"/>	ONYX-SS3V	\$315	<input type="checkbox"/>	LINX-SS3V	\$345	<input type="checkbox"/>	LINX2-SS3V	\$380

ADULT DUAL SUB-OCCIPITAL	8" Pad Size 1 OCC
	10" Pad Size 1 OCC
	6" Pad Size 2 OCC
	6" Pad Size 1 OCC

<input type="checkbox"/>	AXYS-8L	\$435	<input type="checkbox"/>	ONYX-8L	\$475	<input type="checkbox"/>	LINX-8L	\$450	<input type="checkbox"/>	LINX2-8L	\$485
<input type="checkbox"/>	AXYS-8V	\$435	<input type="checkbox"/>	ONYX-8V	\$475	<input type="checkbox"/>	LINX-8V	\$450	<input type="checkbox"/>	LINX2-8V	\$485
<input type="checkbox"/>	AXYS-5L	\$495	<input type="checkbox"/>	ONYX-5L	\$495	<input type="checkbox"/>	LINX-5L	\$470	<input type="checkbox"/>	LINX2-5L	\$505
<input type="checkbox"/>	AXYS-5V	\$495	<input type="checkbox"/>	ONYX-5V	\$495	<input type="checkbox"/>	LINX-5V	\$470	<input type="checkbox"/>	LINX2-5V	\$505
<input type="checkbox"/>	AXYS-2L	\$430	<input type="checkbox"/>	ONYX-2L	\$430	<input type="checkbox"/>	LINX-2L	\$415	<input type="checkbox"/>	LINX2-2L	\$450
<input type="checkbox"/>	AXYS-2V	\$430	<input type="checkbox"/>	ONYX-2V	\$430	<input type="checkbox"/>	LINX-2V	\$415	<input type="checkbox"/>	LINX2-2V	\$450
<input type="checkbox"/>	AXYS-1L	\$430	<input type="checkbox"/>	ONYX-1L	\$430	<input type="checkbox"/>	LINX-1L	\$415	<input type="checkbox"/>	LINX2-1L	\$450
<input type="checkbox"/>	AXYS-1V	\$430	<input type="checkbox"/>	ONYX-1V	\$430	<input type="checkbox"/>	LINX-1V	\$415	<input type="checkbox"/>	LINX2-1V	\$450

PEDIATRIC DUAL SUB-OCCIPITAL	8" Pad Size 3 OCC
	5" Pad Size 4 OCC
	6" Pad Size 3 OCC
	5" Pad Size 3 OCC



<input type="checkbox"/>	AXYS-7L	\$435	<input type="checkbox"/>	ONYX-7L	\$430	<input type="checkbox"/>	LINX-7L	\$450	<input type="checkbox"/>	LINX2-7L	\$485
<input type="checkbox"/>	AXYS-7V	\$435	<input type="checkbox"/>	ONYX-7V	\$430	<input type="checkbox"/>	LINX-7V	\$450	<input type="checkbox"/>	LINX2-7V	\$485
<input type="checkbox"/>	AXYS-6L	\$430	<input type="checkbox"/>	ONYX-6L	\$430	<input type="checkbox"/>	LINX-6L	\$415	<input type="checkbox"/>	LINX2-6L	\$450
<input type="checkbox"/>	AXYS-6V	\$430	<input type="checkbox"/>	ONYX-6V	\$430	<input type="checkbox"/>	LINX-6V	\$415	<input type="checkbox"/>	LINX2-6V	\$450
<input type="checkbox"/>	AXYS-4L	\$430	<input type="checkbox"/>	ONYX-4L	\$430	<input type="checkbox"/>	LINX-4L	\$415	<input type="checkbox"/>	LINX2-4L	\$450
<input type="checkbox"/>	AXYS-4V	\$430	<input type="checkbox"/>	ONYX-4V	\$430	<input type="checkbox"/>	LINX-4V	\$415	<input type="checkbox"/>	LINX2-4V	\$450
<input type="checkbox"/>	AXYS-3L	\$430	<input type="checkbox"/>	ONYX-3L	\$430	<input type="checkbox"/>	LINX-3L	\$415	<input type="checkbox"/>	LINX2-3L	\$450
<input type="checkbox"/>	AXYS-3V	\$430	<input type="checkbox"/>	ONYX-3V	\$430	<input type="checkbox"/>	LINX-3V	\$415	<input type="checkbox"/>	LINX2-3V	\$450

CUDDLES INFANT

<input type="checkbox"/>	AXYS-INFT	\$330	<input type="checkbox"/>	ONYX-INFTL	\$330	N/A				
--------------------------	-----------	-------	--------------------------	------------	-------	------------	--	--	--	--

Head Positioning - Use HCPCS Code E0955







Whitmyer headrests come unassembled. Please add item WHITASSY001 if the dealer would like parts assembled. This is a no charge option.



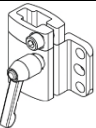



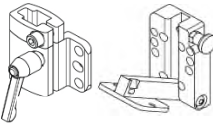

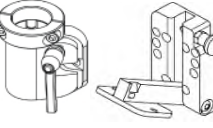
		<input type="checkbox"/> Receiver must be selected at bottom of page		<input type="checkbox"/> Adult - 15" <input type="checkbox"/> Peds - 11" <input type="checkbox"/> EI - 10"		<input type="checkbox"/> Adult - 15" <input type="checkbox"/> Peds - 11" <input type="checkbox"/> EI - 10"
PAD	PRO		COBRA		COBRA-FB	

SINGLE SUB-OCCIPITAL	10" Pad Lrg OCC	<input type="checkbox"/>	PRO-SS10L	\$430	<input type="checkbox"/>	COBRA-SS10L	\$630	<input type="checkbox"/>	FB-COBRA-SS10L	\$730
	6" Pad Lrg OCC	<input type="checkbox"/>	PRO-SS10V	\$430	<input type="checkbox"/>	COBRA-SS10V	\$630	<input type="checkbox"/>	FB-COBRA-SS10V	\$730
	6" Pad Sml OCC	<input type="checkbox"/>	PRO-SS8L	\$420	<input type="checkbox"/>	COBRA-SS8L	\$620	<input type="checkbox"/>	FB-COBRA-SS8L	\$720
	5" Pad Sml OCC	<input type="checkbox"/>	PRO-SS8V	\$420	<input type="checkbox"/>	COBRA-SS8V	\$620	<input type="checkbox"/>	FB-COBRA-SS8V	\$720
ADULT DUAL SUB-OCCIPITAL	8" Pad Size 1 OCC	<input type="checkbox"/>	PRO-SS4L	\$360	<input type="checkbox"/>	COBRA-SS4L	\$560	<input type="checkbox"/>	FB-COBRA-SS4L	\$660
	6" Pad Size 2 OCC	<input type="checkbox"/>	PRO-SS4V	\$360	<input type="checkbox"/>	COBRA-SS4V	\$560	<input type="checkbox"/>	FB-COBRA-SS4V	\$660
	6" Pad Size 1 OCC	<input type="checkbox"/>	PRO-SS3L	\$360	<input type="checkbox"/>	COBRA-SS3L	\$560	<input type="checkbox"/>	FB-COBRA-SS3L	\$660
	6" Pad Size 1 OCC	<input type="checkbox"/>	PRO-SS3V	\$360	<input type="checkbox"/>	COBRA-SS3V	\$560	<input type="checkbox"/>	FB-COBRA-SS3V	\$660
PEDIATRIC DUAL SUB-OCCIPITAL	8" Pad Size 1 OCC	<input type="checkbox"/>	PRO-8L	\$515	<input type="checkbox"/>	COBRA-8L	\$715	<input type="checkbox"/>	FB-COBRA-8L	\$815
	10" Pad Size 1 OCC	<input type="checkbox"/>	PRO-8V	\$515	<input type="checkbox"/>	COBRA-8V	\$715	<input type="checkbox"/>	FB-COBRA-8V	\$815
	6" Pad Size 2 OCC	<input type="checkbox"/>	PRO-5L	\$515	<input type="checkbox"/>	COBRA-5L	\$715	<input type="checkbox"/>	FB-COBRA-5L	\$815
	6" Pad Size 1 OCC	<input type="checkbox"/>	PRO-5V	\$515	<input type="checkbox"/>	COBRA-5V	\$715	<input type="checkbox"/>	FB-COBRA-5V	\$815
	6" Pad Size 1 OCC	<input type="checkbox"/>	PRO-2L	\$470	<input type="checkbox"/>	COBRA-2L	\$670	<input type="checkbox"/>	FB-COBRA-2L	\$770
	6" Pad Size 1 OCC	<input type="checkbox"/>	PRO-2V	\$470	<input type="checkbox"/>	COBRA-2V	\$670	<input type="checkbox"/>	FB-COBRA-2V	\$770
PEDIATRIC DUAL SUB-OCCIPITAL	6" Pad Size 1 OCC	<input type="checkbox"/>	PRO-1L	\$470	<input type="checkbox"/>	COBRA-1L	\$670	<input type="checkbox"/>	FB-COBRA-1L	\$770
	6" Pad Size 1 OCC	<input type="checkbox"/>	PRO-1V	\$470	<input type="checkbox"/>	COBRA-1V	\$670	<input type="checkbox"/>	FB-COBRA-1V	\$770
	8" Pad Size 3 OCC	<input type="checkbox"/>	PRO-7L	\$510	<input type="checkbox"/>	COBRA-7L	\$710	<input type="checkbox"/>	FB-COBRA-7L	\$810
	5" Pad Size 4 OCC	<input type="checkbox"/>	PRO-7V	\$510	<input type="checkbox"/>	COBRA-7V	\$710	<input type="checkbox"/>	FB-COBRA-7V	\$810
	6" Pad Size 3 OCC	<input type="checkbox"/>	PRO-6L	\$460	<input type="checkbox"/>	COBRA-6L	\$660	<input type="checkbox"/>	FB-COBRA-6L	\$760
	5" Pad Size 3 OCC	<input type="checkbox"/>	PRO-6V	\$460	<input type="checkbox"/>	COBRA-6V	\$660	<input type="checkbox"/>	FB-COBRA-6V	\$760
PEDIATRIC DUAL SUB-OCCIPITAL	6" Pad Size 3 OCC	<input type="checkbox"/>	PRO-4L	\$460	<input type="checkbox"/>	COBRA-4L	\$660	<input type="checkbox"/>	FB-COBRA-4L	\$760
	6" Pad Size 3 OCC	<input type="checkbox"/>	PRO-4V	\$460	<input type="checkbox"/>	COBRA-4V	\$660	<input type="checkbox"/>	FB-COBRA-4V	\$760
	6" Pad Size 3 OCC	<input type="checkbox"/>	PRO-3L	\$460	<input type="checkbox"/>	COBRA-3L	\$660	<input type="checkbox"/>	FB-COBRA-3L	\$760
	6" Pad Size 3 OCC	<input type="checkbox"/>	PRO-3V	\$460	<input type="checkbox"/>	COBRA-3V	\$660	<input type="checkbox"/>	FB-COBRA-3V	\$760

Mounting Brackets - Use HCPCS Code E1028

Head Support System Mounting Brackets must be ordered separately, except for COBRA

	AXYS	ONYX	LINX & LINX ²	PRO	COBRA mounting system includes detachable mounting bracket
REMOVABLE MOUNTING BRACKET <small>(PART SOLD SEPARATELY FROM POST & PAD)</small>					
Detachable	<input type="checkbox"/> M2500 \$105	<input type="checkbox"/> M2100-WB \$85	<input type="checkbox"/> M2300 \$165	<input type="checkbox"/> M2200-WB \$185	
REMOVABLE & SWING-AWAY MNT BRACKET <small>(PART SOLD SEPARATELY FROM POST & PAD)</small>					
Swing-Away	<input type="checkbox"/> M5500 \$200	<input type="checkbox"/> M5100 \$185	<input type="checkbox"/> M5300 \$265	<input type="checkbox"/> M5200 \$285	



Lateral Facial Supports																
Note: Cover Selection - Add L = Lycra or V = Dartex Reversed (Example: LFC-PL L)																
																
	SPOT	STANDARD	LONG	OVAL	LARGE-C	MED-C	SMALL-C	FSO-B								
Unilateral	<input type="checkbox"/>	LFC10L \$185 LM115 \$80	<input type="checkbox"/>	LFC15L \$185 LM115 \$80	<input type="checkbox"/>	LFC20L \$185 LM115 \$80	<input type="checkbox"/>	LFC25L \$185 LM115 \$80	<input type="checkbox"/>	LFC30L \$185 LM115 \$80	<input type="checkbox"/>	LFC35L \$185 LM115 \$80	<input type="checkbox"/>	LFC40L \$185 LM115 \$80	<input type="checkbox"/>	LFC80 \$215 LM115 \$80
	<input type="checkbox"/>	LFC10V \$185 LM115 \$80	<input type="checkbox"/>	LFC15V \$185 LM115 \$80	<input type="checkbox"/>	LFC20V \$185 LM115 \$80	<input type="checkbox"/>	LFC25V \$185 LM115 \$80	<input type="checkbox"/>	LFC30V \$185 LM115 \$80	<input type="checkbox"/>	LFC35V \$185 LM115 \$80	<input type="checkbox"/>	LFC40V \$185 LM115 \$80		LFC80 \$215 LM115 \$80
Bilateral	<input type="checkbox"/>	LFC10L \$185	<input type="checkbox"/>	LFC15L \$185	<input type="checkbox"/>	LFC20L \$185	<input type="checkbox"/>	LFC25L \$185	<input type="checkbox"/>	LFC30L \$185	<input type="checkbox"/>	LFC35L \$185	<input type="checkbox"/>	LFC40L \$185	<input type="checkbox"/>	LFC80 \$215
		LFC10L \$185		LFC15L \$185		LFC20L \$185		LFC25L \$185		LFC30L \$185		LFC35L \$185		LFC40L \$185		LFC80 \$215
		LM115 \$80		LM115 \$80		LM115 \$80		LM115 \$80		LM115 \$80		LM115 \$80		LM115 \$80		LM115 \$80
		LM115 \$80		LM115 \$80		LM115 \$80		LM115 \$80		LM115 \$80		LM115 \$80		LM115 \$80		LM115 \$80
	<input type="checkbox"/>	LFC10V \$185	<input type="checkbox"/>	LFC15V \$185	<input type="checkbox"/>	LFC20V \$185	<input type="checkbox"/>	LFC25V \$185	<input type="checkbox"/>	LFC30V \$185	<input type="checkbox"/>	LFC35V \$185	<input type="checkbox"/>	LFC40V \$185	<input type="checkbox"/>	LFC80 \$215
		LFC10V \$185		LFC15V \$185		LFC20V \$185		LFC25V \$185		LFC30V \$185		LFC35V \$185		LFC40V \$185		LFC80 \$215
		LM115 \$80		LM115 \$80		LM115 \$80		LM115 \$80		LM115 \$80		LM115 \$80		LM115 \$80		LM115 \$80
		LM115 \$80		LM115 \$80		LM115 \$80		LM115 \$80		LM115 \$80		LM115 \$80		LM115 \$80		LM115 \$80
Pad Only*	<input type="checkbox"/>	PL10L \$70	<input type="checkbox"/>	PL15L \$100	<input type="checkbox"/>	PL20L \$100	<input type="checkbox"/>	P600L \$100	<input type="checkbox"/>	PL30L \$100	<input type="checkbox"/>	PL35L \$100	<input type="checkbox"/>	PL40L \$90	N/A	
	<input type="checkbox"/>	PL10V \$70	<input type="checkbox"/>	PL15V \$100	<input type="checkbox"/>	PL20V \$100	<input type="checkbox"/>	P600V \$100	<input type="checkbox"/>	PL30V \$100	<input type="checkbox"/>	PL35V \$100	<input type="checkbox"/>	PL40V \$90		

ADDITIONAL LATERAL FACIAL SUPPORT PARTS

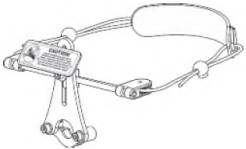

*Note: If ordering an additional Lateral Facial Support, select both a Lateral Facial Support Pad Only from above and an Infinity Mount from below as well

✓	Option #	Definition	Price
<input type="checkbox"/>	242161	Infinity Dual Mount Assembly*	\$195
<input type="checkbox"/>	LM1010	Lateral Facial Support*	\$125

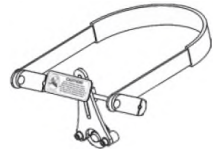
ANTERIOR HEAD SUPPORT



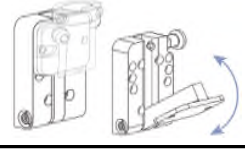
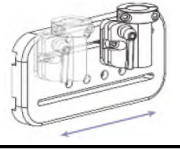
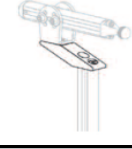





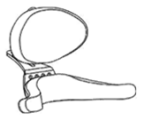

									
	DYNAMIC FOREHEAD STRAP	DFS²	STRAP CAP	STATIC FOREHEAD STRAP					
ADULT	<input type="checkbox"/>	DFS10 \$289	<input type="checkbox"/>	DFSQ10 \$349	<input type="checkbox"/>	CAP10 (black) \$400	<input type="checkbox"/>	HU10	\$315
PEDS	<input type="checkbox"/>	DFS30 \$289	<input type="checkbox"/>	DFSQ30 \$349	<input type="checkbox"/>	CAP30-R (red) \$400			
	<input type="checkbox"/>		<input type="checkbox"/>		<input type="checkbox"/>	CAP30-B (blue) \$400			

CUSTOM MOUNTING OPTIONS

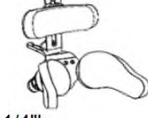

									
FLEX INTERFACE BRACKET	UNIVERSAL SWING-AWAY MOUNT	SLIDE MOUNT	PRO OFF-SET MOUNTING SYSTEM	ONYX REARWARD OFF-SET VERTICAL ROD					
<input type="checkbox"/>	M9450 (hard) \$185	<input type="checkbox"/>	M5000 \$100	<input type="checkbox"/>	M7010 \$95	<input type="checkbox"/>	PRC7070 \$163	<input type="checkbox"/>	OX6030 \$60
<input type="checkbox"/>	M9451 (soft) \$185								

TOOLS			
✓	Option #	Definition	Price
<input type="checkbox"/>	BOLT LUBE	Bolt Lube	\$0
<input type="checkbox"/>	T2500	Tool Kit	\$3.33

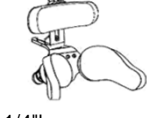
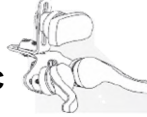
Pad Styles

SINGLE SUB-OCCIPITAL	 <p>10" Pad Large OCC SS10 PAD = 10"w X 5"h SUB OCC = 9"w X 3"h</p>	 <p>6" Pad Large OCC SS8 PAD = 6"w X 4"h SUB OCC = 9"w X 3"h</p>	 <p>6" Pad Small OCC SS4 PAD = 6"w X 4"h SUB OCC = 8"w X 2"h</p>	 <p>5" Pad Small OCC SS3 PAD = 5"w X 2-1/4"h SUB OCC = 8"w X 2"h</p>
	 <p>8" Pad Size 1 OCC 8 PAD = 8"w X 5"h SUB OCC = 8"w X 3"h</p>	 <p>10" Pad Size 1 OCC 5 PAD = 10"w X 5"h SUB OCC = 8"w X 3"h</p>	 <p>6" Pad Size 2 OCC 2 PAD = 6"w X 4"h SUB OCC = 4"w X 3"h</p>	 <p>6" Pad Size 1 OCC 1 PAD = 6"w X 4"h SUB OCC = 8"w X 3"h</p>
	 <p>8" Pad Size 3 OCC 7 PAD = 8"w X 5"h SUB OCC = 4"w X 3"h</p>	 <p>5" Pad Size 4 OCC 6 PAD = 5"w X 2-1/4"h SUB OCC = 4"w X 2-1/2"h</p>	 <p>6" Pad Size 3 OCC 4 PAD = 6"w X 4"h SUB OCC = 4"w X 3"h</p>	 <p>5" Pad Size 3 OCC 3 PAD = 5"w X 2-1/4"h SUB OCC = 4"w X 3"h</p>
	 <p>8" Pad Size 3 OCC 7 PAD = 8"w X 5"h SUB OCC = 4"w X 3"h</p>			

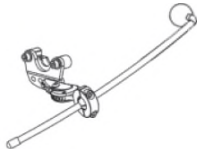
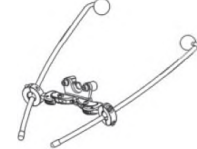
Lateral Facial Supports

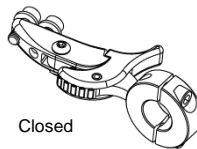
MOUNTING HARDWARE					
	Unilateral	Bilateral	Infinity Mount	Swing-Away Mount	LM115

CUSTOM MOUNTS

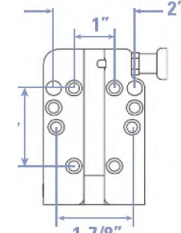
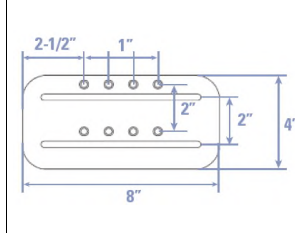
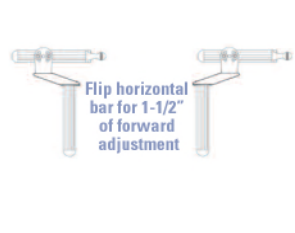
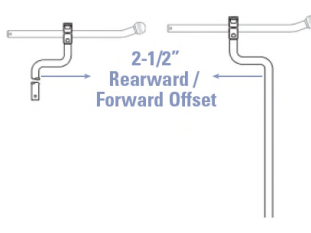
			
UNIVERSAL SWING-AWAY MOUNT	SLIDE MOUNT	PRO OFF-SET MOUNTING SYSTEM	ONYX REARWARD OFF-SET VERTICAL ROD



Sunrise Medical (US) LLC

2842 Business Park Ave. · Fresno, CA 93727 · USA

Customer Service: 800-333-4000 Fax: 800-300-7502 Email: orders@sunmed.com www.sunrisemedical.com

©4/2020 MK-129442 REV. D