



**JAY SureFit**  
Now known as  
**AES Lite - Custom Seating**  
November 2015

**Mark For:**

Date: \_\_\_\_\_  
 Dealer Acct #: \_\_\_\_\_  
 Dealer: \_\_\_\_\_  
 Dealer Contact: \_\_\_\_\_  
 Dealer Address: \_\_\_\_\_  
 Dealer City: \_\_\_\_\_ ST: \_\_\_\_\_ ZIP: \_\_\_\_\_  
 Dealer Phone: ( ) \_\_\_\_\_ Fax: ( ) \_\_\_\_\_  
 Confirmation Email: \_\_\_\_\_  
 Confirm Via:  Fax  Email

**Submitting for:**

Quote  Order  
 PO#: \_\_\_\_\_  
**ADDITIONAL SHIPPING INFORMATION**  
 Ship To: \_\_\_\_\_  
 Attention: \_\_\_\_\_  
 Address: \_\_\_\_\_  
 Address: \_\_\_\_\_  
 Ship To City: \_\_\_\_\_ ST: \_\_\_\_\_ ZIP: \_\_\_\_\_  
 Ship To Phone: ( ) \_\_\_\_\_ Fax: ( ) \_\_\_\_\_

**CLIENT MEASUREMENTS**

First Name	
Age	
Diagnosis	
Height	
Weight	
1. Top of Head to Seat	
2. Top of Shoulder to Seat*	
3. Under Arm to Seat	
4. Trunk Depth	
5. Actual Sitting Depth*	
6. Foot Length	
7. Width of Head	
8. Shoulder Width	
9. Chest Width	
10. Hip Width*	
11. Left Lower Leg Length*	
12. Right Lower Leg Length*	

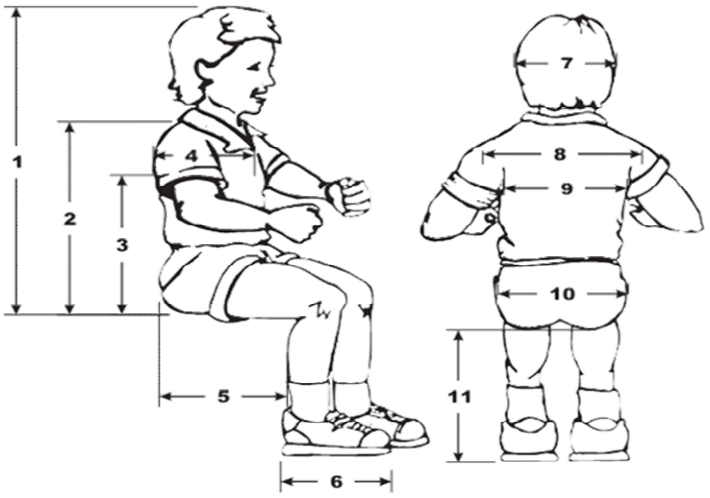

**Client Wheelchair Description**

Model	
Back Height	
Custom Embroidery (12 Ltr Limit)	
<input type="checkbox"/> Name	
Style	<input type="checkbox"/> Script/Cursive
	<input type="checkbox"/> Block/Uppercase <input type="checkbox"/> Block/Lowercase
Stock Monogram Design	
<input type="checkbox"/> Color	
T-Nut Location	<input type="checkbox"/> Do Not Mark 0677Z01
Combine with Wheelchair	<input type="checkbox"/> See Quickie/Zippie OF 0677Z01
	<input type="checkbox"/> Existing Chair Serial # 067XL03
Chair Width	
Seat Rail Diameter	<input type="checkbox"/> 7/8" 067XZ01
	<input type="checkbox"/> 1" 067XZ02
Chair Depth	
Upper Back Cane Diameter	<input type="checkbox"/> 3/4" 067XL03
	<input type="checkbox"/> 7/8" 067XL01
	<input type="checkbox"/> 1" 067XL02
	<input type="checkbox"/> 1 1/8" 067XL03
Lower Back Cane Diameter	<input type="checkbox"/> 7/8" 067XQ02
	<input type="checkbox"/> 1" 067XQ01
	<input type="checkbox"/> 1 1/8" 067XQ03

**Seating Specifications**

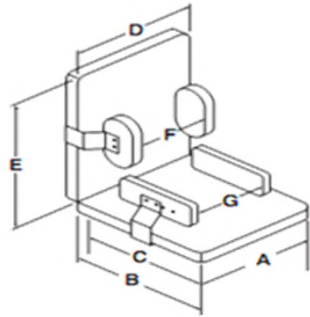

A. Seat Width	
B. Seat Depth (Total)	
C. Seat Depth (Usable)	
D. Back Width	
E. Back Height	
F. Width Between Laterals	
G. Width Between Hips	

**Notes**

**BACKREST**

**Back Style**

<input type="checkbox"/>	067YS01	Planar Back	\$195.00
<input type="checkbox"/>	067YS04	Omit	NC

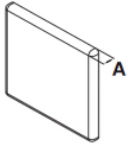

A\*   
\* Foam Thickness Only

**Cover Options**

<input type="checkbox"/>	067YU01	Standard Zipper Access Cover	N/C
<input type="checkbox"/>	067YU04	Removable Zipper Access Cover	\$190.00

**Back Misc.**

<input type="checkbox"/>	067YT05	Two Piece Cushion & Base Back	\$145.00
--------------------------	---------	-------------------------------	----------

*Not Available with Adjustable Lumbar*

**BACK MODIFICATION - E2617**

*Note: Modifications retail is added to the price of the Planar Back*

<input type="checkbox"/>	067YS08	Curved Wood Back	\$270.00
--------------------------	---------	------------------	----------

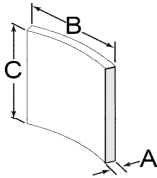

A\*   
\* Foam Thickness Only  
B   
C

<input type="checkbox"/>	067YS12	Adjustable Lumbar Support	\$280.00
--------------------------	---------	---------------------------	----------

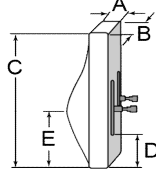

A\*   
\* Foam Thickness Only  
B   
C   
D\*\*   
\*\* Minimum Length is 3.5"  
E

*Not Available with Curved Foam, Cube Back, Adj Lumbar, & Lumbar*

*Not Available with Curved Back, Cube Back, Bi-Angular, & Lumbar*

<input type="checkbox"/>	067YS02	Curved Foam Back	\$245.00
--------------------------	---------	------------------	----------

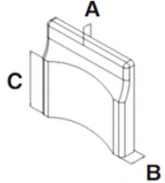

A\*   
\* Foam Thickness Only  
B   
C

<input type="checkbox"/>	067YT02	Biangular Modification	\$225.00
--------------------------	---------	------------------------	----------

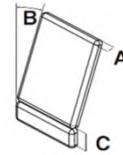

A\*   
\* Foam Thickness Only  
B   
C   
*N/A w/Quickie TS Snap 2 or 4 Pin*

*Not Available with Curved Wood, Cube Back, & Adj Lumbar*

*Not Available with Curved Wood & Adj Lumbar*

<input type="checkbox"/>	067YT04	I Back Modification	\$150.00
--------------------------	---------	---------------------	----------

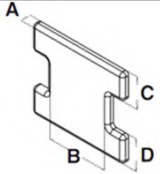

A\*   
\* Foam Thickness Only  
B   
C   
D

<input type="checkbox"/>	067YS07	Cube Back	\$390.00
--------------------------	---------	-----------	----------

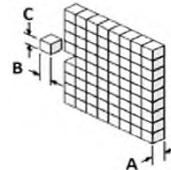

A\*   
\* Foam Thickness Only  
B   
C

*Not Available with Adjustable Lumbar*

<input type="checkbox"/>	067YT03	T Back Modification	\$135.00
--------------------------	---------	---------------------	----------

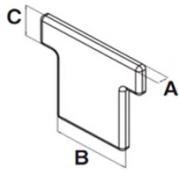

A\*   
\* Foam Thickness Only  
B   
C\*\*   
\*\*Minimum length is 3"

<input type="checkbox"/>	067YS06	Lumbar with or without Straps	\$150.00
--------------------------	---------	-------------------------------	----------

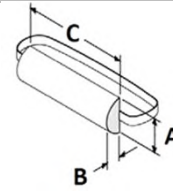

A\*   
\* Foam Thickness Only  
B   
C   
 With Straps (External)  
 Without Straps (Internal)

*Not Available with Quickie TS 2 or 4 Pin Hardware*

*Not Available with Curved Wood Backrest*

**BACK UPHOLSTERY**

*Note: Visit [www.sunrisemedical.com](http://www.sunrisemedical.com) for a full list of colors available.*

**Contact Surface**

<input type="checkbox"/>	067ZD22	RubateX - Black	NC
<input type="checkbox"/>	067ZD01	Naugahyde/Vinyl	NC
		Color: <input type="text"/>	
<input type="checkbox"/>	067ZD29	Dartex - Black	NC
<input type="checkbox"/>	067ZD30	Reverse Dartex - Black	NC

**Non-Contact Surface**

<input type="checkbox"/>	067ZD31	RubateX - Black	NC
<input type="checkbox"/>	067ZD32	Naugahyde/Vinyl	NC
		Color: <input type="text"/>	
<input type="checkbox"/>	067ZD48	Dartex - Black	NC
<input type="checkbox"/>	067ZD49	Reverse Dartex - Black	NC

**BACK HARDWARE - E2617**

**Seat to Back Hardware**

<input type="checkbox"/>	067ZF06	Bracket STD Flush (Pr)	\$165.00
<input type="checkbox"/>	067ZF07	Bracket Adjustable Wide	\$227.00



Back Hardware	With Seat to Back Hardware	Without Seat to Back Hdw
Snaptitle 1" STD**	<input type="checkbox"/> 067ZE43 \$177.50	<input type="checkbox"/> 067ZE21 \$355.00
Snaptitle 1 1/2" Drop	<input type="checkbox"/> 067ZE44 \$177.50	<input type="checkbox"/> 067ZE24 \$355.00
Snaptitle 3" Drop	<input type="checkbox"/> 067ZE45 \$177.50	<input type="checkbox"/> 067ZE26 \$355.00
Quickie TS Snap 2 pin	<input type="checkbox"/> 067ZE46 \$115.00	<input type="checkbox"/> 067ZE29 \$190.00
Quickie TS Snap 4 pin**	<input type="checkbox"/> 067ZE47 \$115.00	<input type="checkbox"/> 067ZE22 \$190.00
Jay 3 Back Style Short w/o bracket		<input type="checkbox"/> 067ZE36 \$250.00
Jay 3 Back Style Long w/o bracket		<input type="checkbox"/> 067ZE37 \$250.00
Universal Transit Hardware**	<input type="checkbox"/> 067ZE49 \$300.00	<input type="checkbox"/> 067ZE39 \$600.00
Adjustable J&L (J-2 Hole & L-6 Hole) Std	<input type="checkbox"/> 067ZE48 \$85.00	<input type="checkbox"/> 067ZE35 \$170.00
Adjustable J&L (J-6 Hole & L-2 Hole)	<input type="checkbox"/> 067ZE55 \$85.00	<input type="checkbox"/> 067ZE40 \$170.00
Adjustable J&L (Std) w/ Shurlock Rel/Fixed		<input type="checkbox"/> 067ZE62 \$270.00
Adjustable J&L (Std) w/ Shurlock Release	<input type="checkbox"/> 067ZE63 \$165.00	<input type="checkbox"/> 067ZE64 \$330.00
Omit Back Hardware	<input type="checkbox"/> 067ZE31 NC	

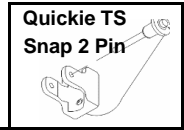
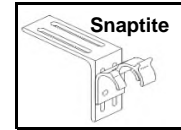

**J3 Back Style**

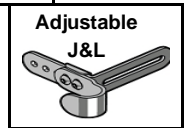
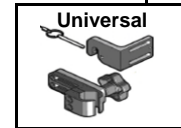
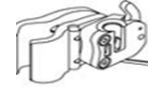

\*\* Transit Approved

**BACK FOAM OPTIONS**

**Foam Construction**

<input type="checkbox"/>	067YV01	Single Layer Foam	N/C
<input type="checkbox"/>	067YV02	2 Layer Foam	N/C
<input type="checkbox"/>	067YV03	3 Layer Foam	N/C
<input type="checkbox"/>	067YV04	Omit Back Foam	N/C

**Foam Layer Density**

	Top	Middle	Bottom
HR Foam-50	<input type="checkbox"/>	<input type="checkbox"/>	<input type="checkbox"/>
HR Foam-70	<input type="checkbox"/>	<input type="checkbox"/>	<input type="checkbox"/>
T Foam-XS (Yellow)	<input type="checkbox"/>	<input type="checkbox"/>	<input type="checkbox"/>
T Foam-S (Pink)	<input type="checkbox"/>	<input type="checkbox"/>	<input type="checkbox"/>
Sunmate-Soft	<input type="checkbox"/>	<input type="checkbox"/>	<input type="checkbox"/>
Sunmate-Medium	<input type="checkbox"/>	<input type="checkbox"/>	<input type="checkbox"/>
Sunmate-MediumSoft	<input type="checkbox"/>	<input type="checkbox"/>	<input type="checkbox"/>
Sunmate-Firm	<input type="checkbox"/>	<input type="checkbox"/>	<input type="checkbox"/>
Pudgee	<input type="checkbox"/>	<input type="checkbox"/>	<input type="checkbox"/>

**Back Foam Options**

<input type="checkbox"/>	0675U01	Incontinent Wrap	N/C
--------------------------	---------	------------------	-----

**Top Thickness**

<b>HR Foam - 50 or 70</b>					
<input type="checkbox"/>	067YY01	1/2"	\$20	<input type="checkbox"/>	067YY05 2 1/2" \$100
<input type="checkbox"/>	067YY02	1"	\$40	<input type="checkbox"/>	067YY06 3" \$120
<input type="checkbox"/>	067YY03	1 1/2"	\$60	<input type="checkbox"/>	067YY07 3 1/2" \$140
<input type="checkbox"/>	067YY04	2"	\$80		
<b>T Foam - XS or S</b>					
<input type="checkbox"/>	067YY26	1/2"	\$20	<input type="checkbox"/>	067YY29 2" \$80
<input type="checkbox"/>	067YY27	1"	\$40	<input type="checkbox"/>	067YY30 2 1/2" \$100
<input type="checkbox"/>	067YY28	1 1/2"	\$60	<input type="checkbox"/>	067YY31 3" \$120
<b>Sunmate Soft, Medium, MediumSoft, or Firm</b>					
<input type="checkbox"/>	067YY09	1/2"	\$45	<input type="checkbox"/>	067YY13 2 1/2" \$225
<input type="checkbox"/>	067YY10	1"	\$90	<input type="checkbox"/>	067YY14 3" \$270
<input type="checkbox"/>	067YY11	1 1/2"	\$135	<input type="checkbox"/>	067YY15 3 1/2" \$315
<input type="checkbox"/>	067YY12	2"	\$180		
<b>Pudgee</b>					
<input type="checkbox"/>	067YY17	1/2"	\$150	<input type="checkbox"/>	067YY20 2" \$600
<input type="checkbox"/>	067YY18	1"	\$300	<input type="checkbox"/>	067YY21 2 1/2" \$750
<input type="checkbox"/>	067YY19	1 1/2"	\$450	<input type="checkbox"/>	067YY22 3" \$900

**Middle Thickness**

<b>HR Foam - 50 or 70</b>					
<input type="checkbox"/>	067ZA01	1/2"	\$20	<input type="checkbox"/>	067ZA05 2 1/2" \$100
<input type="checkbox"/>	067ZA02	1"	\$40	<input type="checkbox"/>	067ZA06 3" \$120
<input type="checkbox"/>	067ZA03	1 1/2"	\$60	<input type="checkbox"/>	067ZA07 3 1/2" \$140
<input type="checkbox"/>	067ZA04	2"	\$80		
<b>T Foam - XS or S</b>					
<input type="checkbox"/>	067ZA26	1/2"	\$20	<input type="checkbox"/>	067ZA29 2" \$80
<input type="checkbox"/>	067ZA27	1"	\$40	<input type="checkbox"/>	067ZA30 2 1/2" \$100
<input type="checkbox"/>	067ZA28	1 1/2"	\$60	<input type="checkbox"/>	067ZA31 3" \$120
<b>Sunmate Soft, Medium, MediumSoft, or Firm</b>					
<input type="checkbox"/>	067ZA09	1/2"	\$45	<input type="checkbox"/>	067ZA13 2 1/2" \$225
<input type="checkbox"/>	067ZA10	1"	\$90	<input type="checkbox"/>	067ZA14 3" \$270
<input type="checkbox"/>	067ZA11	1 1/2"	\$135	<input type="checkbox"/>	067ZA15 3 1/2" \$315
<input type="checkbox"/>	067ZA12	2"	\$180		
<b>Pudgee</b>					
<input type="checkbox"/>	067ZA17	1/2"	\$150	<input type="checkbox"/>	067ZA20 2" \$600
<input type="checkbox"/>	067ZA18	1"	\$300	<input type="checkbox"/>	067ZA21 2 1/2" \$750
<input type="checkbox"/>	067ZA19	1 1/2"	\$450	<input type="checkbox"/>	067ZA22 3" \$900

**Bottom Thickness**

<b>HR Foam - 50 or 70</b>					
<input type="checkbox"/>	067ZC01	1/2"	\$20	<input type="checkbox"/>	067ZC05 2 1/2" \$100
<input type="checkbox"/>	067ZC02	1"	\$40	<input type="checkbox"/>	067ZC06 3" \$120
<input type="checkbox"/>	067ZC03	1 1/2"	\$60	<input type="checkbox"/>	067ZC07 3 1/2" \$140
<input type="checkbox"/>	067ZC04	2"	\$80		
<b>T Foam - XS or S</b>					
<input type="checkbox"/>	067ZC26	1/2"	\$20	<input type="checkbox"/>	067ZC29 2" \$80
<input type="checkbox"/>	067ZC27	1"	\$40	<input type="checkbox"/>	067ZC30 2 1/2" \$100
<input type="checkbox"/>	067ZC28	1 1/2"	\$60	<input type="checkbox"/>	067ZC31 3" \$120
<b>Sunmate Soft, Medium, MediumSoft, or Firm</b>					
<input type="checkbox"/>	067ZC09	1/2"	\$45	<input type="checkbox"/>	067ZC13 2 1/2" \$225
<input type="checkbox"/>	067ZC10	1"	\$90	<input type="checkbox"/>	067ZC14 3" \$270
<input type="checkbox"/>	067ZC11	1 1/2"	\$135	<input type="checkbox"/>	067ZC15 3 1/2" \$315
<input type="checkbox"/>	067ZC12	2"	\$180		
<b>Pudgee</b>					
<input type="checkbox"/>	067ZC17	1/2"	\$150	<input type="checkbox"/>	067ZC20 2" \$600
<input type="checkbox"/>	067ZC18	1"	\$300	<input type="checkbox"/>	067ZC21 2 1/2" \$750
<input type="checkbox"/>	067ZC19	1 1/2"	\$450	<input type="checkbox"/>	067ZC22 3" \$900

**SEAT - E2609**

Seat Style		
<input type="checkbox"/>	067YH01	Standard Planar
<input type="checkbox"/>	067YH06	Omit

Seat Style Option		
<input type="checkbox"/>	067YH08	Omit Plywood
		NC

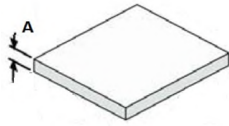

A\*   
\* Foam Thickness Only

**SEAT MODIFICATION**

*Note: Modifications retail is added to the price of the Planar Back*

<input type="checkbox"/>	067YI02	Asymmetrical Seat	\$135.00
--------------------------	---------	-------------------	----------

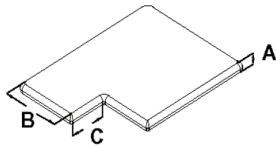

A\*   
\* Foam Thickness Only  
B   
C   
Long Side:  R  L

*Note: If adding a Medial Thigh add at least 1.5" past center line for proper mounting.*

<input type="checkbox"/>	067YH03	Anti-Thrust Modification	\$240.00
--------------------------	---------	--------------------------	----------

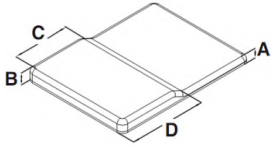

A\*   
\* Foam Thickness Only  
B   
C   
D

<input type="checkbox"/>	067YH04	Contour Seat	\$320.00
--------------------------	---------	--------------	----------

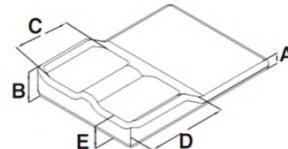

A\*   
\* Foam Thickness Only  
B   
C   
D   
E

Cover Options			
<input type="checkbox"/>	067YJ01	Standard Zipper Access Cover	N/C
<input type="checkbox"/>	067YJ03	Removable Zipper Access Cover	\$190.00

Cover Options Misc.			
<input type="checkbox"/>	NEW	OMIT VELCRO	NC
<input type="checkbox"/>	067IU01	Add Velcro Strips (Bottom of the Cushion)	\$25.00
<input type="checkbox"/>	067IU02	Add Velcro Strips (Top of the Cushion)	\$25.00

Growth Notches (W" X D")			
<input type="checkbox"/>	067GO01	2" x 2" Growth Tail Notch	N/C
<input type="checkbox"/>	067GO02	2" x 3" Growth Tail Notch	N/C

Type of Velcro			
<input type="checkbox"/>	067IV01	Hook	NC
<input type="checkbox"/>	067IV02	Loop (Standard)	NC

Seat Misc			
<input type="checkbox"/>	067YI05	Two Piece Cushion & Base	\$145.00

**SEAT UPHOLSTERY**

*Note: Visit [www.sunrisemedical.com](http://www.sunrisemedical.com) for a full list of colors available.*

Contact Surface			
<input type="checkbox"/>	067YR22	Rubatex - Black	NC
<input type="checkbox"/>	067YR01	Naugahyde/Vinyl	NC
		Color: <input type="text"/>	
<input type="checkbox"/>	067YR29	Dartex - Black	NC
<input type="checkbox"/>	067YR30	Reverse Dartex - Black	NC

Non-Contact Surface			
<input type="checkbox"/>	067YR31	Rubatex - Black	NC
<input type="checkbox"/>	067YR32	Naugahyde/Vinyl	NC
		Color: <input type="text"/>	
<input type="checkbox"/>	067YR48	Dartex - Black	NC
<input type="checkbox"/>	067YR49	Reverse Dartex - Black	NC

**SEAT HARDWARE - E2609**

Seat Hardware	With Seat to Back Hardware	Without Seat to Back Hdw
Snaptitle 1" STD**	<input type="checkbox"/> 067ZE50 \$177.50	<input type="checkbox"/> 067ZE11 \$355.00
Snaptitle 1 1/2" Drop	<input type="checkbox"/> 067ZE51 \$177.50	<input type="checkbox"/> 067ZE14 \$355.00
Snaptitle 3" Drop	<input type="checkbox"/> 067ZE52 \$177.50	<input type="checkbox"/> 067ZE16 \$355.00
Quickie TS Snap 2 pin	<input type="checkbox"/> 067ZE53 \$115.00	<input type="checkbox"/> 067ZE13 \$190.00
Quickie TS Snap 4 pin**	<input type="checkbox"/> 067ZE54 \$115.00	<input type="checkbox"/> 067ZE22 \$190.00
Flush Hooks	<input type="checkbox"/> 067ZE65 \$85.00	<input type="checkbox"/> 067ZE66 \$170.00
Universal Transit Standard**	<input type="checkbox"/> 067ZE56 \$300.00	<input type="checkbox"/> 067ZE41 \$600.00
Universal Transit Space Saver**	<input type="checkbox"/> 067ZE57 \$300.00	<input type="checkbox"/> 067ZE42 \$600.00
Adjustable J&L (J-2 Hole & L-6 Hole) Std	<input type="checkbox"/> 067ZE55 \$115.00	<input type="checkbox"/> 067ZE40 \$225.00
Adjustable J&L (Std) w/ Shurlock Rel/Fixed		<input type="checkbox"/> 067ZE62 \$270.00
Adjustable J&L (Std) w/ Shurlock Release	<input type="checkbox"/> 067ZE63 \$165.00	<input type="checkbox"/> 067ZE64 \$330.00
Omit Seat Hardware	<input type="checkbox"/> 067ZE17 NC	

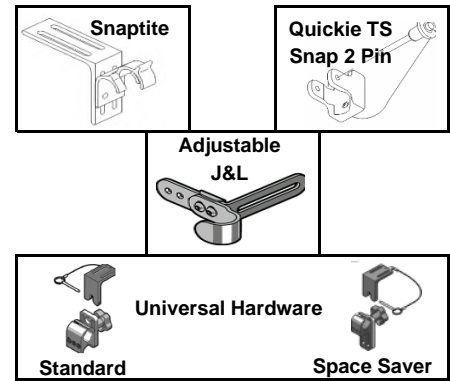

\*\* Transit Approved

Note: Space saver hardware will be used for any seat under 14" Wide

**SEAT FOAM OPTIONS**

Foam Construction			
<input type="checkbox"/>	067YK01	Single Layer Foam	N/C
<input type="checkbox"/>	067YK02	2 Layer Foam	N/C
<input type="checkbox"/>	067YK03	3 Layer Foam	N/C
<input type="checkbox"/>	067YK04	Omit Seat Foam	N/C

Foam Layer Density			
	Top	Middle	Bottom
HR Foam-50	<input type="checkbox"/>	<input type="checkbox"/>	<input type="checkbox"/>
HR Foam-70	<input type="checkbox"/>	<input type="checkbox"/>	<input type="checkbox"/>
T Foam-XS (Yellow)	<input type="checkbox"/>	<input type="checkbox"/>	<input type="checkbox"/>
T Foam-S (Pink)	<input type="checkbox"/>	<input type="checkbox"/>	<input type="checkbox"/>
Sunmate-Soft	<input type="checkbox"/>	<input type="checkbox"/>	<input type="checkbox"/>
Sunmate-Medium	<input type="checkbox"/>	<input type="checkbox"/>	<input type="checkbox"/>
Sunmate-MediumSoft	<input type="checkbox"/>	<input type="checkbox"/>	<input type="checkbox"/>
Sunmate-Firm	<input type="checkbox"/>	<input type="checkbox"/>	<input type="checkbox"/>
Pudgee	<input type="checkbox"/>	<input type="checkbox"/>	<input type="checkbox"/>

Seat Foam Options			
<input type="checkbox"/>	0675U01	Incontinent Wrap	N/C

Top Thickness					
<b>HR Foam - 50 or 70</b>					
<input type="checkbox"/>	067YM01	1/2"	\$20	<input type="checkbox"/>	067YM05 2 1/2" \$100
<input type="checkbox"/>	067YM02	1"	\$40	<input type="checkbox"/>	067YM06 3" \$120
<input type="checkbox"/>	067YM03	1 1/2"	\$60	<input type="checkbox"/>	067YM07 3 1/2" \$140
<input type="checkbox"/>	067YM04	2"	\$80		

<b>T Foam - XS or S</b>					
<input type="checkbox"/>	067YM26	1/2"	\$20	<input type="checkbox"/>	067YM29 2" \$80
<input type="checkbox"/>	067YM27	1"	\$40	<input type="checkbox"/>	067YM30 2 1/2" \$100
<input type="checkbox"/>	067YM28	1 1/2"	\$60	<input type="checkbox"/>	067YM31 3" \$120

<b>Sunmate Soft, Medium, MediumSoft, or Firm</b>					
<input type="checkbox"/>	067YM09	1/2"	\$45	<input type="checkbox"/>	067YM13 2 1/2" \$225
<input type="checkbox"/>	067YM10	1"	\$90	<input type="checkbox"/>	067YM14 3" \$270
<input type="checkbox"/>	067YM11	1 1/2"	\$135	<input type="checkbox"/>	067YM15 3 1/2" \$315
<input type="checkbox"/>	067YM12	2"	\$180		

<b>Pudgee</b>					
<input type="checkbox"/>	067YM17	1/2"	\$150	<input type="checkbox"/>	067YM20 2" \$600
<input type="checkbox"/>	067YM18	1"	\$300	<input type="checkbox"/>	067YM21 2 1/2" \$750
<input type="checkbox"/>	067YM19	1 1/2"	\$450	<input type="checkbox"/>	067YM22 3" \$900

Middle Thickness					
<b>HR Foam - 50 or 70</b>					
<input type="checkbox"/>	067YO01	1/2"	\$20	<input type="checkbox"/>	067YO05 2 1/2" \$100
<input type="checkbox"/>	067YO02	1"	\$40	<input type="checkbox"/>	067YO06 3" \$120
<input type="checkbox"/>	067YO03	1 1/2"	\$60	<input type="checkbox"/>	067YO07 3 1/2" \$140
<input type="checkbox"/>	067YO04	2"	\$80		

<b>T Foam - XS or S</b>					
<input type="checkbox"/>	067YO26	1/2"	\$20	<input type="checkbox"/>	067YO29 2" \$80
<input type="checkbox"/>	067YO27	1"	\$40	<input type="checkbox"/>	067YO30 2 1/2" \$100
<input type="checkbox"/>	067YO28	1 1/2"	\$60	<input type="checkbox"/>	067YO31 3" \$120

<b>Sunmate Soft, Medium, MediumSoft, or Firm</b>					
<input type="checkbox"/>	067YO09	1/2"	\$45	<input type="checkbox"/>	067YO13 2 1/2" \$225
<input type="checkbox"/>	067YO10	1"	\$90	<input type="checkbox"/>	067YO14 3" \$270
<input type="checkbox"/>	067YO11	1 1/2"	\$135	<input type="checkbox"/>	067YO15 3 1/2" \$315
<input type="checkbox"/>	067YO12	2"	\$180		

<b>Pudgee</b>					
<input type="checkbox"/>	067YO17	1/2"	\$150	<input type="checkbox"/>	067YO20 2" \$600
<input type="checkbox"/>	067YO18	1"	\$300	<input type="checkbox"/>	067YO21 2 1/2" \$750
<input type="checkbox"/>	067YO19	1 1/2"	\$450	<input type="checkbox"/>	067YO22 3" \$900

Bottom Thickness					
<b>HR Foam - 50 or 70</b>					
<input type="checkbox"/>	067YQ01	1/2"	\$20	<input type="checkbox"/>	067YQ05 2 1/2" \$100
<input type="checkbox"/>	067YQ02	1"	\$40	<input type="checkbox"/>	067YQ06 3" \$120
<input type="checkbox"/>	067YQ03	1 1/2"	\$60	<input type="checkbox"/>	067YQ07 3 1/2" \$140
<input type="checkbox"/>	067YQ04	2"	\$80		

<b>T Foam - XS or S</b>					
<input type="checkbox"/>	067YQ26	1/2"	\$20	<input type="checkbox"/>	067YQ29 2" \$80
<input type="checkbox"/>	067YQ27	1"	\$40	<input type="checkbox"/>	067YQ30 2 1/2" \$100
<input type="checkbox"/>	067YQ28	1 1/2"	\$60	<input type="checkbox"/>	067YQ31 3" \$120

<b>Sunmate Soft, Medium, MediumSoft, or Firm</b>					
<input type="checkbox"/>	067YQ09	1/2"	\$45	<input type="checkbox"/>	067YQ13 2 1/2" \$225
<input type="checkbox"/>	067YQ10	1"	\$90	<input type="checkbox"/>	067YQ14 3" \$270
<input type="checkbox"/>	067YQ11	1 1/2"	\$135	<input type="checkbox"/>	067YQ15 3 1/2" \$315
<input type="checkbox"/>	067YQ12	2"	\$180		

<b>Pudgee</b>					
<input type="checkbox"/>	067YQ17	1/2"	\$150	<input type="checkbox"/>	067YQ20 2" \$600
<input type="checkbox"/>	067YQ18	1"	\$300	<input type="checkbox"/>	067YQ21 2 1/2" \$750
<input type="checkbox"/>	067YQ19	1 1/2"	\$450	<input type="checkbox"/>	067YQ22 3" \$900

**HEAD SUPPORT - E0955**

Pad Style			
<input type="checkbox"/>	067ZH14	8" Plush	\$160.00
<input type="checkbox"/>	067ZH15	10" Plush	\$165.00
<input type="checkbox"/>	067ZH16	14" Plush	\$165.00
<input type="checkbox"/>	067ZH17	19" Plush	\$230.00
<input type="checkbox"/>	067ZH18	Standard Adjust-a-Plush	\$250.00
<input type="checkbox"/>	067ZH19	Narrow Adjust-a-Plush	\$250.00
<input type="checkbox"/>	067ZH20	Small Contour Cradle	\$130.00
<input type="checkbox"/>	067ZH21	Med Contour Cradle	\$145.00
<input type="checkbox"/>	067ZH22	Large Contour Cradle	\$150.00
<input type="checkbox"/>	067ZH24	Omit	N/C

Pad Cover			
<input type="checkbox"/>	067Y024	Lycra	N/C
<input type="checkbox"/>	067Y025	Reverse Dartex	N/C

Mounting System - E1028			
<input type="checkbox"/>	067ZK08	ONYX Detachable Bracket	\$175.00
<input type="checkbox"/>	067ZK09	ONYX Detachable w/offset vertical bar	\$180.00
<input type="checkbox"/>	067ZK10	AXYS Detachable Bracket	\$255.00
<input type="checkbox"/>	067ZK11	LINX Detachable Bracket	\$290.00
<input type="checkbox"/>	067ZK12	COBRA Detachable Bracket	\$335.00

Mounting Plate			
<input type="checkbox"/>	067JD01	Universal Mounting Plate	\$85.00
<input type="checkbox"/>	067JD02	Swing Away Plate	\$55.00

Dynamic Forehead Strap			
<input type="checkbox"/>	067JE01	Dynamic Forehead Strap Adult	\$185.00

**LATERAL THORACIC SUPPORTS - E0956**

Bracket Style - Pair			
<input type="checkbox"/>	067ZS01	Fixed	\$100.00
<input type="checkbox"/>	067ZS02	Swing Away E1028	\$400.00
<input type="checkbox"/>	067ZS03	Omit	NC

Bracket Offset			
<input type="checkbox"/>	067ZT04	Flush	N/C
<input type="checkbox"/>	067ZT05	1" Offset	N/C
<input type="checkbox"/>	067ZT06	2" Offset	N/C

Bracket Profile			
<input type="checkbox"/>	067JG01	Standard - 1"	N/C
<input type="checkbox"/>	067JG02	Medium - 2"	N/C
<input type="checkbox"/>	067JG03	High - 3"	N/C

Additional Hardware/Options			
<input type="checkbox"/>	067ZY05	Quick Adj(sumtr/wntf-pr)	\$225.00
<input type="checkbox"/>	067ZY10	Hdw Bracket Covers	\$50.00

Pad Size - Sold as Pair			
<input type="checkbox"/>	067ZV01	3"H x 4"L	\$125.00
<input type="checkbox"/>	067ZV05	4"H x 5"L	\$125.00
<input type="checkbox"/>	067ZV06	4"H x 6"L	\$125.00
<input type="checkbox"/>	067ZV13	5"H x 6"L	\$125.00
<input type="checkbox"/>	Custom		
		___ H x ___ L ___ Thick*	\$175.00

\* Foam thickness only

Pad Style			
<input type="checkbox"/>	067ZU01	Flat D	NC
<input type="checkbox"/>	067ZU02	Curved D	NC
<input type="checkbox"/>	067ZU08	Taper Style Pad	NC

Spacers			
<input type="checkbox"/>	067ZY10	1/4" Per Side	\$15.00
<input type="checkbox"/>	067ZY06	1/2" Per Side	\$30.00
<input type="checkbox"/>	067ZY07	1" Per Side	\$60.00
<input type="checkbox"/>	067ZY08	1 1/2" Per Side	\$90.00
<input type="checkbox"/>	067ZY09	2" Per Side	\$120.00

**LATERAL PELVIC SUPPORTS - E0956**

Bracket Style - Pair			
<input type="checkbox"/>	067XO01	Fixed	\$100.00
<input type="checkbox"/>	067XO03	Removable E1028	\$400.00
<input type="checkbox"/>	067XO05	Omit	NC

Bracket Offset			
<input type="checkbox"/>	067X01	Flush	N/C
<input type="checkbox"/>	067X02	1" Offset	N/C
<input type="checkbox"/>	067X03	2" Offset	N/C

Bracket Profile			
<input type="checkbox"/>	067JG04	Standard - 1"	N/C
<input type="checkbox"/>	067JG05	Medium - 2"	N/C
<input type="checkbox"/>	067JG06	High - 3"	N/C

Pad Size - Sold as Pair			
<input type="checkbox"/>	067XR01	3"H x 4"L	\$130.00
<input type="checkbox"/>	067XR05	4"H x 5"L	\$130.00
<input type="checkbox"/>	067XR06	4"H x 6"L	\$130.00
<input type="checkbox"/>	067XR11	5"H x 6"L	\$130.00
<input type="checkbox"/>	Custom		
		___ H x ___ L ___ Thick*	\$180.00

\* Foam thickness only

<input type="checkbox"/>	067XR10	Custom Contour to Seat	\$320.00
--------------------------	---------	------------------------	----------

Spacers			
<input type="checkbox"/>	067XS09	1/4" Per Side	\$15.00
<input type="checkbox"/>	067XS05	1/2" Per Side	\$30.00
<input type="checkbox"/>	067XS06	1" Per Side	\$60.00
<input type="checkbox"/>	067XS07	1 1/2" Per Side	\$90.00
<input type="checkbox"/>	067XS08	2" Per Side	\$120.00

**LATERAL THIGH/KNEE SUPPORTS - E0956**

Bracket Style - Pair			
<input type="checkbox"/>	067XJ01	Fixed	\$100.00
<input type="checkbox"/>	067XJ03	Removable E1028	\$400.00
<input type="checkbox"/>	067XJ05	Frm Mnt Flip Dwn-(Long)	\$600.00
<input type="checkbox"/>	067XJ06	Omit	NC

Bracket Offset			
<input type="checkbox"/>	067XK05	Flush	N/C
<input type="checkbox"/>	067XK06	1" Offset	N/C
<input type="checkbox"/>	067XK07	2" Offset	N/C

*Not Available with Flip Down Style*

Bracket Profile			
<input type="checkbox"/>	067JG07	Standard - 1"	N/C
<input type="checkbox"/>	067JG08	Medium - 2"	N/C
<input type="checkbox"/>	067JG09	High - 3"	N/C

*Not Available with Flip Down Style*

Spacers			
<input type="checkbox"/>	067XN09	1/4" Per Side	\$15.00
<input type="checkbox"/>	067XN05	1/2" Per Side	\$30.00
<input type="checkbox"/>	067XN06	1" Per Side	\$60.00
<input type="checkbox"/>	067XN07	1 1/2" Per Side	\$90.00
<input type="checkbox"/>	067XN08	2" Per Side	\$120.00

*Not Available with Flip Down Style*

Pad Size - Pair			
<input type="checkbox"/>	067XM01	3"H x 4"L	\$130.00
<input type="checkbox"/>	067XM05	4"H x 5"L	\$130.00
<input type="checkbox"/>	067XM06	4"H x 6"L	\$130.00
<input type="checkbox"/>	067XM12	5"H x 6"L	\$130.00
<input type="checkbox"/>	067XM13	3" Knee Pad*	\$125.00
<input type="checkbox"/>	067XM14	4" Knee Pad*	\$125.00
<input type="checkbox"/>	Custom		
		___ H x ___ L ___ Thick**	\$180.00

\* Available with Flip Down Style Only  
\*\* Foam thickness only

**MEDIAL THIGH ABDUCTOR - E0957**

**Bracket Style**

<input type="checkbox"/>	067KH8	Push Btn Flip Dwn E1028	\$245.00
<input type="checkbox"/>	067KH10	Pull Away AES Style E1028	\$285.00
<input type="checkbox"/>	067KH11	Omit	NC

**Pad Style**

<input type="checkbox"/>	067KH9	Oval	N/C
<input type="checkbox"/>	067KH10	Wedge	N/C

**Pad Size**

<input type="checkbox"/>	067KH4	Sml (3x4x3)	\$170.00
<input type="checkbox"/>	067KH5	Med (4.5x5x3)	\$170.00
<input type="checkbox"/>	067KH6	Lrg (5x5x4)	\$170.00
<input type="checkbox"/>	067KH7	Custom-See Diagram	\$220.00

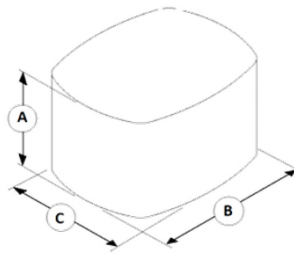

**Custom Oval Sizes**

A. Height	
B. Length	
C. Width	

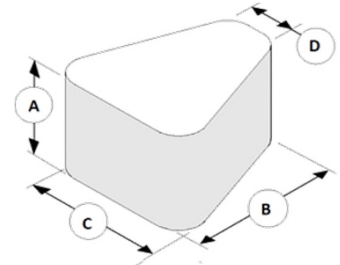

**Custom Wedge Sizes**

A. Height	
B. Length	
C. Width Front	
D. Width Rear	

**MISCELLANEOUS**

**Anterior Pelvic Belts - E0978**

**JAY Standard 2 Point Belt - Push Button 1"**

<input type="checkbox"/>	067ZZ10	No Pad	\$40.00
<input type="checkbox"/>	067ZZ11	4.5" Pad	\$40.00
<input type="checkbox"/>	067ZZ12	5.5" Pad	\$40.00
<input type="checkbox"/>	067ZZ13	7.5" Pad	\$40.00

**JAY Standard 2 Point Belt - Push Button 1 1/2"**

<input type="checkbox"/>	067ZZ14	No Pad	\$40.00
<input type="checkbox"/>	067ZZ15	7.5" Pad	\$40.00
<input type="checkbox"/>	067ZZ16	9.5" Pad	\$40.00

**JAY Medial 4 Point Belt - Push Button 1 1/2"**

<input type="checkbox"/>	067ZZ17	4.5" Pad	\$40.00
<input type="checkbox"/>	067ZZ18	5.5" Pad	\$40.00

**JAY V-Contour Pelvic 4 Point Belt - Push Button Varies**

<input type="checkbox"/>	067WV01	Small Pad - 1" Push Button	\$125.00
<input type="checkbox"/>	067WV02	Medium Pad - 1 1/2" Push Button	\$125.00
<input type="checkbox"/>	067WV03	Large Pad - 2" Push Button	\$125.00

**Anterior Trunk Supports - E0960**

**1. Style**

<input type="checkbox"/>	067JJ01	JAY Classic - Structured	\$140.00
<input type="checkbox"/>	067JJ02	JAY Classic - Dynamic	\$140.00
<input type="checkbox"/>	067JJ03	JAY Contour - Structured	\$140.00
<input type="checkbox"/>	067JJ04	JAY Contour - Dynamic	\$140.00
<input type="checkbox"/>	067JJ16	JAY Back Pack Style Structured	\$140.00
<input type="checkbox"/>	067JJ17	JAY Back Pack Style Dynamic	\$140.00

**2a. Classic and Contour Size**

<input type="checkbox"/>	067JJ05	Early Intervention	NC
<input type="checkbox"/>	067JJ06	X-Small	NC
<input type="checkbox"/>	067JJ07	Small	NC
<input type="checkbox"/>	067JJ08	Medium	NC
<input type="checkbox"/>	067JJ09	Large	NC
<input type="checkbox"/>	067JJ10	X-Large	NC

**2b. Back Pack Size**

<input type="checkbox"/>	067A481	12"	NC
<input type="checkbox"/>	067A482	18"	NC

**3. Strap Guides (Optional)**

<input type="checkbox"/>	067JJ11	Strap Guide	\$40.00
--------------------------	---------	-------------	---------

**Shoe Holders (E0951/E0952) Pair**

**1. Style**

<input type="checkbox"/>	067XU05	Padded	\$140.00
<input type="checkbox"/>	067XU06	Tendon Relief	\$140.00

**2. Size**

<input type="checkbox"/>	067XU01	Small	NC
<input type="checkbox"/>	067XU02	Medium	NC
<input type="checkbox"/>	067XU03	Large	NC
<input type="checkbox"/>	067XU04	X-Large	NC

**Ankle Positioners**

**1. Style**

<input type="checkbox"/>	067F320	Ankle Positioner (Foot & Ankle)	\$125.00
<input type="checkbox"/>	067F321	Flexi Feet	\$125.00

**2. Size**

<input type="checkbox"/>	067IL01	X-Small - N/A w/ Ankle Positioner	NC
<input type="checkbox"/>	067IL02	Small	NC
<input type="checkbox"/>	067IL03	Medium	NC
<input type="checkbox"/>	067IL04	Large	NC
<input type="checkbox"/>	067IL05	X-Large - N/A w/ Flexi Feet	NC