

Mark For:

Date: _____
 Dealer Acct #: _____
 Dealer: _____
 Dealer Contact: _____
 Dealer Address: _____
 Dealer City: _____ ST: _____ ZIP: _____
 Dealer Phone: () _____ Fax: () _____
 Confirmation Email: _____
 Confirm Via: Fax Email

Submitting for:
 Quote Order

PO#: _____

ADDITIONAL SHIPPING INFORMATION

Ship To: _____
 Attention: _____
 Address: _____
 Address: _____
 Ship To City: _____ ST: _____ ZIP: _____
 Ship To Phone: () _____ Fax: () _____

The **HCPCS CODES** herein are based on PDAC verification or interpretation of Medicare definitions and guidelines. Non-Medicare payers may accept alternative **HCPCS CODES**, including misc. codes to ensure access for their enrollees. The use of **HCPCS CODES** does not ensure coverage or payment.

Head Positioning - Use HCPCS Code E0955

Whitmyer headrests come unassembled. Please add item WHITASSY001 if the dealer would like parts assembled. This is a no charge option.

 Note: For cover selection, **L** = Lycra and **V** = Dartex Reversed (Example: AXYS-HUFALL or AXYS-HUFALV)

			<input type="checkbox"/> Receiver must be selected on pg 2		<input type="checkbox"/> Receiver must be selected on pg 2		<input type="checkbox"/> Receiver must be selected on pg 2		<input type="checkbox"/> Receiver must be selected on pg 2		
PAD		AXYS		ONYX		LINX		LINX²			
HEADS UP - COMMON SIZES	Fixed Arm	Large	<input type="checkbox"/> AXYS-HUFALL \$332	<input type="checkbox"/> ONYX-HUFALL \$332	<input type="checkbox"/> LINX-HUFALL \$332	<input type="checkbox"/> LINX2-HUFALL \$373	<input type="checkbox"/> AXYS-HUFALV \$332	<input type="checkbox"/> ONYX-HUFALV \$332	<input type="checkbox"/> LINX-HUFALV \$332	<input type="checkbox"/> LINX2-HUFALV \$373	
		Medium	<input type="checkbox"/> AXYS-HUFAML \$332	<input type="checkbox"/> ONYX-HUFAML \$332	<input type="checkbox"/> LINX-HUFAML \$332	<input type="checkbox"/> LINX2-HUFAML \$373	<input type="checkbox"/> AXYS-HUFAMV \$332	<input type="checkbox"/> ONYX-HUFAMV \$332	<input type="checkbox"/> LINX-HUFAMV \$332	<input type="checkbox"/> LINX2-HUFAMV \$373	
		Small	<input type="checkbox"/> AXYS-HUFASL \$332	<input type="checkbox"/> ONYX-HUFASL \$332	<input type="checkbox"/> LINX-HUFASL \$332	<input type="checkbox"/> LINX2-HUFASL \$373	<input type="checkbox"/> AXYS-HUFASV \$332	<input type="checkbox"/> ONYX-HUFASV \$332	<input type="checkbox"/> LINX-HUFASV \$332	<input type="checkbox"/> LINX2-HUFASV \$373	
		Early Intervention	<input type="checkbox"/> AXYS-HUFAEIL \$332	<input type="checkbox"/> ONYX-HUFAEIL \$332	<input type="checkbox"/> LINX-HUFAEIL \$332	<input type="checkbox"/> LINX2-HUFAEIL \$373	<input type="checkbox"/> AXYS-HUFAEIV \$332	<input type="checkbox"/> ONYX-HUFAEIV \$332	<input type="checkbox"/> LINX-HUFAEIV \$332	<input type="checkbox"/> LINX2-HUFAEIV \$373	
		Swing-Away Arms*	Large	<input type="checkbox"/> AXYS-HUSALL \$401	<input type="checkbox"/> ONYX-HUSALL \$401	<input type="checkbox"/> LINX-HUSALL \$401	<input type="checkbox"/> LINX2-HUSALL \$441	<input type="checkbox"/> AXYS-HUSALV \$401	<input type="checkbox"/> ONYX-HUSALV \$401	<input type="checkbox"/> LINX-HUSALV \$401	<input type="checkbox"/> LINX2-HUSALV \$441
			Medium	<input type="checkbox"/> AXYS-HUSAML \$401	<input type="checkbox"/> ONYX-HUSAML \$401	<input type="checkbox"/> LINX-HUSAML \$401	<input type="checkbox"/> LINX2-HUSAML \$441	<input type="checkbox"/> AXYS-HUSAMV \$401	<input type="checkbox"/> ONYX-HUSAMV \$401	<input type="checkbox"/> LINX-HUSAMV \$401	<input type="checkbox"/> LINX2-HUSAMV \$441
	Small		<input type="checkbox"/> AXYS-HUSASL \$401	<input type="checkbox"/> ONYX-HUSASL \$401	<input type="checkbox"/> LINX-HUSASL \$401	<input type="checkbox"/> LINX2-HUSASL \$441	<input type="checkbox"/> AXYS-HUSASV \$401	<input type="checkbox"/> ONYX-HUSASV \$401	<input type="checkbox"/> LINX-HUSASV \$401	<input type="checkbox"/> LINX2-HUSASV \$441	
	Early Intervention		<input type="checkbox"/> AXYS-HUSAEIL \$401	<input type="checkbox"/> ONYX-HUSAEIL \$401	<input type="checkbox"/> LINX-HUSAEIL \$401	<input type="checkbox"/> LINX2-HUSAEIL \$441	<input type="checkbox"/> AXYS-HUSAEIV \$401	<input type="checkbox"/> ONYX-HUSAEIV \$401	<input type="checkbox"/> LINX-HUSAEIV \$401	<input type="checkbox"/> LINX2-HUSAEIV \$441	

Head Positioning - Use HCPCS Code E0955





Whitmyer headrests come unassembled. Please add item WHITASSY001 if the dealer would like parts assembled. This is a no charge option.

			<input type="checkbox"/> Receiver must be selected on pg 2		<input type="checkbox"/> Adult - 15" <input type="checkbox"/> Peds - 11" <input type="checkbox"/> EI - 10"		<input type="checkbox"/> Adult - 15" <input type="checkbox"/> Peds - 11" <input type="checkbox"/> EI - 10"		
PAD		PRO		COBRA		COBRA-FB			
HEADS UP - COMMON SIZES	Fixed Arm	Large	<input type="checkbox"/> PRO-HUFALL \$373	<input type="checkbox"/> COBRA-HUFALL \$598	<input type="checkbox"/> FBCOB-HUFALL \$712	<input type="checkbox"/> PRO-HUFALV \$373	<input type="checkbox"/> COBRA-HUFALV \$598	<input type="checkbox"/> FBCOB-HUFALV \$712	
		Medium	<input type="checkbox"/> PRO-HUFAML \$373	<input type="checkbox"/> COBRA-HUFAML \$598	<input type="checkbox"/> FBCOB-HUFAML \$712	<input type="checkbox"/> PRO-HUFAMV \$373	<input type="checkbox"/> COBRA-HUFAMV \$598	<input type="checkbox"/> FBCOB-HUFAMV \$712	
		Small	<input type="checkbox"/> PRO-HUFASL \$373	<input type="checkbox"/> COBRA-HUFASL \$598	<input type="checkbox"/> FBCOB-HUFASL \$712	<input type="checkbox"/> PRO-HUFASV \$373	<input type="checkbox"/> COBRA-HUFASV \$598	<input type="checkbox"/> FBCOB-HUFASV \$712	
		Early Intervention	<input type="checkbox"/> PRO-HUFAEIL \$373	<input type="checkbox"/> COBRA-HUFAEIL \$598	<input type="checkbox"/> FBCOB-HUFAEIL \$712	<input type="checkbox"/> PRO-HUFAEIV \$373	<input type="checkbox"/> COBRA-HUFAEIV \$598	<input type="checkbox"/> FBCOB-HUFAEIV \$712	
		Swing-Away Arms*	Large	<input type="checkbox"/> PRO-HUSALL \$451	<input type="checkbox"/> COBRA-HUSALL \$677	<input type="checkbox"/> FBCOB-HUSALL \$790	<input type="checkbox"/> PRO-HUSALV \$451	<input type="checkbox"/> COBRA-HUSALV \$677	<input type="checkbox"/> FBCOB-HUSALV \$790
			Medium	<input type="checkbox"/> PRO-HUSAML \$451	<input type="checkbox"/> COBRA-HUSAML \$677	<input type="checkbox"/> FBCOB-HUSAML \$790	<input type="checkbox"/> PRO-HUSAMV \$451	<input type="checkbox"/> COBRA-HUSAMV \$677	<input type="checkbox"/> FBCOB-HUSAMV \$790
	Small		<input type="checkbox"/> PRO-HUSASL \$451	<input type="checkbox"/> COBRA-HUSASL \$677	<input type="checkbox"/> FBCOB-HUSASL \$790	<input type="checkbox"/> PRO-HUSASV \$451	<input type="checkbox"/> COBRA-HUSASV \$677	<input type="checkbox"/> FBCOB-HUSASV \$790	
	Early Intervention		<input type="checkbox"/> PRO-HUSAEIL \$451	<input type="checkbox"/> COBRA-HUSAEIL \$677	<input type="checkbox"/> FBCOB-HUSAEIL \$790	<input type="checkbox"/> PRO-HUSAEIV \$451	<input type="checkbox"/> COBRA-HUSAEIV \$677	<input type="checkbox"/> FBCOB-HUSAEIV \$790	

*See Page 2 for all configurations available

Mounting Brackets - Use HCPCS Code E1028



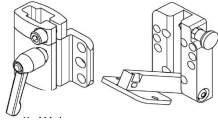
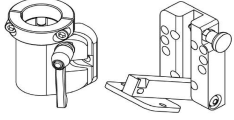
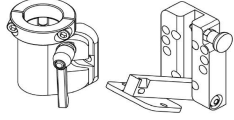
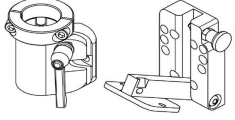



Head Support System Mounting Brackets must be ordered separately, except for COBRA

	AXYS	ONYX	LINX & LINX ²	PRO	COBRA mounting system includes detachable mounting bracket
REMOVABLE MOUNTING BRACKET (PART SOLD SEPARATELY FROM POST & PAD)					
Detachable	<input type="checkbox"/> M2500 \$119	<input type="checkbox"/> M2100-WB \$97	<input type="checkbox"/> M2300 \$186	<input type="checkbox"/> M2200-WB \$209	
REMOVABLE & SWING-AWAY MNT BRACKET (PART SOLD SEPARATELY FROM POST & PAD)					
Swing-Away	<input type="checkbox"/> M5500 \$226	<input type="checkbox"/> M5100 \$209	<input type="checkbox"/> M5300 \$299	<input type="checkbox"/> M5200 \$321	

HEADS UP - HEAD AND NECK POSITIONING SYSTEM ORDERING GUIDE

Head Support System Mounting Brackets must be ordered separately, except for COBRA

STEP 1: SELECT HARDWARE SYSTEM

							
	<input type="checkbox"/> AXYS-HU-	<input type="checkbox"/> ONYX-HU-	<input type="checkbox"/> LINX-HU-	<input type="checkbox"/> LINX2-HU-	<input type="checkbox"/> PRO-HU-	<input type="checkbox"/> COBRA-HU-	<input type="checkbox"/> FBCOB-HU-
W/O OCC Pad	\$401	\$401	\$401	\$441	\$451	\$677	\$790
W/ OCC Pad	\$513	\$513	\$513	\$553	\$565	\$790	\$904

STEP 2: SELECT NECK WIDTH



- I = Infant 3.3" wide
- S = Small 4" wide
- M = Medium 4.6" wide
- L = Large 5.8" wide

STEP 4: SELECT SWING OUT SUPPORT ARM LENGTH



- S = Short
 - L = Long
- Infant & Small: Short = 5.63" Long = 7.25"*
Medium & Large: Short = 7" Long = 9"

STEP 5: SELECT FOAM TYPE

- S = Standard
- C = Comfort

STEP 6: SELECT COVER

- L = Lycra Neoprene
- V = Dartex Reversed

STEP 7: SELECT OPTIONAL OCC PADS

Available on Short Heights Only

- O5 = Pediatric 5" Pad (Short Infant Sizes)
- O6 = Adult 6" Pad (Short Small Sizes)
- O8 = Plush 8" Pad (Short Medium Sizes)
- O10 = Plush 10" Pad (Short Large Sizes)
- N/A

BUILD YOUR HEADS UP SMART PART NUMBER

STEP 1
Enter Hardware System Part Number

STEP 2
Enter I, S, M, or L

STEP 3
Enter T or S

STEP 4
Enter S or L

STEP 5
Enter S or C









STEP 6
Enter L or V



STEP 7 (Optional)
Enter -O5, -O6, -O8, or -O10

STEP 3: SELECT CONTOUR CRADLE HEIGHT



- T = Tall
- S = Short

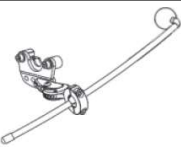
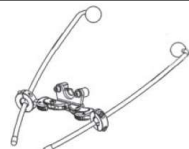

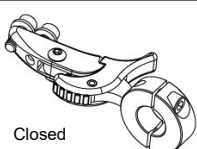
Lateral Facial Supports																	
Note: Cover Selection - Add L = Lycra or V = Dartex Reversed (Example: LFC-PL L)																	
																	
	2"	2.25" x 5"	2.25" x 7"	4" x 6"	2" x 6"	1.75" x 5"	1.25" x 4"										
	SPOT	STANDARD	LONG	OVAL	LARGE-C	MED-C	SMALL-C			FSO-B							
Unilateral	<input type="checkbox"/>	LFC10-CSL \$248 LM115 \$90	<input type="checkbox"/>	LFC15-CSL \$248 LM115 \$90	<input type="checkbox"/>	LFC20-CSL \$248 LM115 \$90	<input type="checkbox"/>	LFC25-CSL \$248 LM115 \$90	<input type="checkbox"/>	LFC30-CSL \$248 LM115 \$90	<input type="checkbox"/>	LFC35-CSL \$248 LM115 \$90	<input type="checkbox"/>	LFC40-CSL \$248 LM115 \$90	<input type="checkbox"/>	LFC80-CS \$288 LM115 \$90	
	<input type="checkbox"/>	LFC10-CSV \$248 LM115 \$90	<input type="checkbox"/>	LFC15-CSV \$248 LM115 \$90	<input type="checkbox"/>	LFC20-CSV \$248 LM115 \$90	<input type="checkbox"/>	LFC25-CSV \$248 LM115 \$90	<input type="checkbox"/>	LFC30-CSV \$248 LM115 \$90	<input type="checkbox"/>	LFC35-CSV \$248 LM115 \$90	<input type="checkbox"/>	LFC40-CSV \$248 LM115 \$90			
	<input type="checkbox"/>	LFC10-CS2L \$463 LM115 \$90	<input type="checkbox"/>	LFC15-CS2L \$463 LM115 \$90	<input type="checkbox"/>	LFC20-CS2L \$463 LM115 \$90	<input type="checkbox"/>	LFC25-CS2L \$463 LM115 \$90	<input type="checkbox"/>	LFC30-CS2L \$463 LM115 \$90	<input type="checkbox"/>	LFC35-CS2L \$463 LM115 \$90	<input type="checkbox"/>	LFC40-CS2L \$463 LM115 \$90		<input type="checkbox"/>	LFC80-CS2 \$529 LM115 \$90
	<input type="checkbox"/>	LFC10-CS2V \$463 LM115 \$90	<input type="checkbox"/>	LFC15-CS2V \$463 LM115 \$90	<input type="checkbox"/>	LFC20-CS2V \$463 LM115 \$90	<input type="checkbox"/>	LFC25-CS2V \$463 LM115 \$90	<input type="checkbox"/>	LFC30-CS2V \$463 LM115 \$90	<input type="checkbox"/>	LFC35-CS2V \$463 LM115 \$90	<input type="checkbox"/>	LFC40-CS2V \$463 LM115 \$90			
Pad Only*	<input type="checkbox"/>	PL10L \$80	<input type="checkbox"/>	PL15L \$113	<input type="checkbox"/>	PL20L \$113	<input type="checkbox"/>	P600L \$113	<input type="checkbox"/>	PL30L \$113	<input type="checkbox"/>	PL35L \$113	<input type="checkbox"/>	PL40L \$102		N/A	
	<input type="checkbox"/>	PL10V \$80	<input type="checkbox"/>	PL15V \$113	<input type="checkbox"/>	PL20V \$113	<input type="checkbox"/>	P600V \$113	<input type="checkbox"/>	PL30V \$113	<input type="checkbox"/>	PL35V \$113	<input type="checkbox"/>	PL40V \$102			

Lateral Facial Supports					
MOUNTING HARDWARE					
	Unilateral	Bilateral	Infinity Mount	Swing-Away Mount	LM115

LATERAL FACIAL SUPPORT PARTS

*Note: If ordering an additional Lateral Facial Support, select both a Lateral Facial Support Pad Only from page 3 and an Infinity Mount from below as well

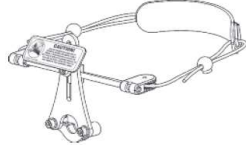
✓	Option #	Definition	Price
<input type="checkbox"/>	242161	Infinity Dual Mount Assembly*	\$220
<input type="checkbox"/>	LM1010	Lateral Facial Support*	\$142

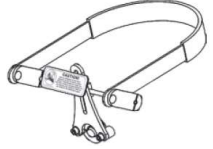
ANTERIOR HEAD SUPPORT									
									
	DYNAMIC FOREHEAD STRAP	DFS²	STRAP CAP	STATIC FOREHEAD STRAP					
ADULT	<input type="checkbox"/>	DFS10 \$326	<input type="checkbox"/>	DFSQ10 \$395	<input type="checkbox"/>	CAP10 (black) \$451	<input type="checkbox"/>	HU10 \$356	
PEDS	<input type="checkbox"/>	DFS30 \$326	<input type="checkbox"/>	DFSQ30 \$395	<input type="checkbox"/>	CAP30-R (red) \$451			
	<input type="checkbox"/>				<input type="checkbox"/>	CAP30-B (blue) \$451			

MOUNTING OPTIONS

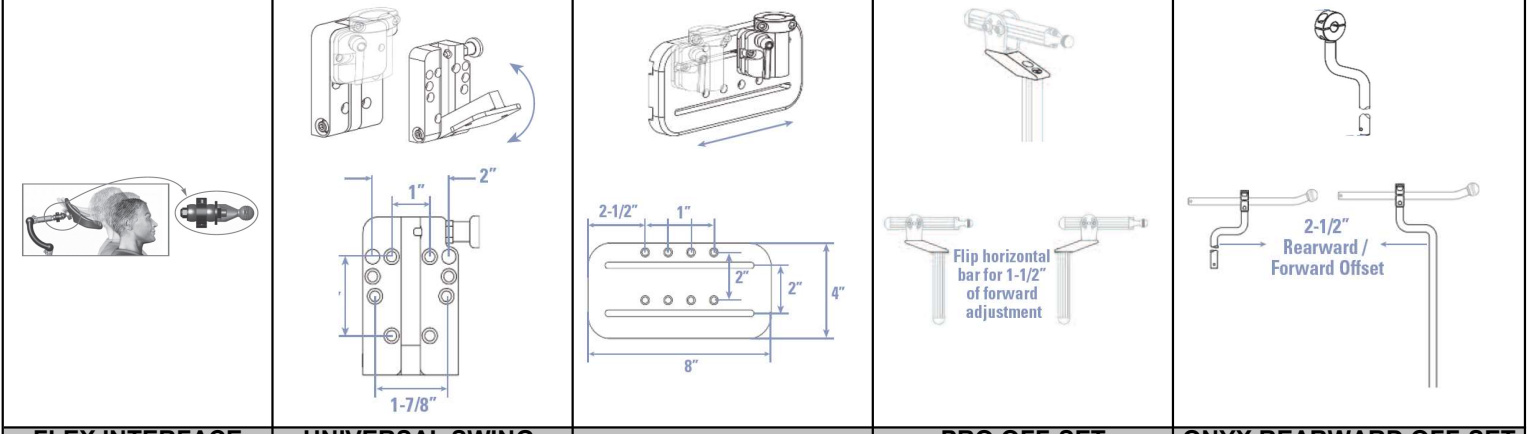

FLEX INTERFACE BRACKET	UNIVERSAL SWING-AWAY MOUNT	SLIDE MOUNT	PRO OFF-SET MOUNTING SYSTEM	ONYX REARWARD OFF-SET VERTICAL ROD
<input type="checkbox"/> M9450 (hard) \$209 <input type="checkbox"/> M9451 (soft) \$209	<input type="checkbox"/> M5000 \$113	<input type="checkbox"/> M7010 \$107	<input type="checkbox"/> PRC7070 \$184	<input type="checkbox"/> OX6030 \$68

TOOLS

<input checked="" type="checkbox"/>	Option #	Definition	Price
<input type="checkbox"/>	BOLT LUBE	Bolt Lube	\$9.00
<input type="checkbox"/>	T2500	Tool Kit	\$7.00

Pad Styles

HEADS UP COMMON SIZES				
	Large HU-L 5.8" Neck Width 9" Long Arms Standard Foam	Medium HU-M 4.6" Neck Width 9" Long Arms Standard Foam	Small HU-S 4" Neck Width 5.6" Short Arms Standard Foam	Early Intervention HU-I 3.3" Neck Width 5.6" Short Arms Standard Foam



Sunrise Medical (US) LLC
 2842 Business Park Ave. · Fresno, CA 93727 · USA