

Mark For: \_\_\_\_\_

Submitting for:  Quote  Order

Date: \_\_\_\_\_

PO#: \_\_\_\_\_

Dealer Acct #: \_\_\_\_\_

Dealer: \_\_\_\_\_

Dealer Contact: \_\_\_\_\_

Dealer Address: \_\_\_\_\_

Dealer City: \_\_\_\_\_ ST: \_\_\_\_\_ ZIP: \_\_\_\_\_

Dealer Phone: ( ) \_\_\_\_\_ Fax: ( ) \_\_\_\_\_

Confirmation Email: \_\_\_\_\_

Confirm Via:  Fax  Email

### ADDITIONAL SHIPPING INFORMATION

Ship To: \_\_\_\_\_

Attention: \_\_\_\_\_

Address: \_\_\_\_\_

Address: \_\_\_\_\_

Ship To City: \_\_\_\_\_ ST: \_\_\_\_\_ ZIP: \_\_\_\_\_





Ship To Phone: ( ) \_\_\_\_\_ Fax: ( ) \_\_\_\_\_

The **HCPCS CODES** herein are based on PDAC verification or interpretation of Medicare definitions and guidelines. Non-Medicare payers may accept alternative **HCPCS CODES**, including misc. codes to ensure access for their enrollees. The use of **HCPCS CODES** does not ensure coverage or payment.

### Head Positioning - Use HCPCS Code E0955

Whitmyer headrests come unassembled. Please add item WHITASSY001 if the dealer would like parts assembled. This is a no charge option.

Note: For cover selection, **L** = Lycra and **V** = Dartex Reversed (Example: AXYS-HUFALL or AXYS-HUFALV)

		<input type="checkbox"/> Receiver must be selected on pg 2		<input type="checkbox"/> Receiver must be selected on pg 2		<input type="checkbox"/> Receiver must be selected on pg 2		<input type="checkbox"/> Receiver must be selected on pg 2	
		<b>PAD</b>	<b>AXYS</b>	<b>ONYX</b>	<b>LINX</b>			<b>LINX<sup>2</sup></b>	
<b>HEADS UP - COMMON SIZES</b>	<b>Fixed Arm</b>	Large	<input type="checkbox"/> AXYS-HUFALL \$316	<input type="checkbox"/> ONYX-HUFALL \$316	<input type="checkbox"/> LINX-HUFALL \$316	<input type="checkbox"/> LINX2-HUFALL \$355			
		Medium	<input type="checkbox"/> AXYS-HUFALV \$316	<input type="checkbox"/> ONYX-HUFALV \$316	<input type="checkbox"/> LINX-HUFALV \$316	<input type="checkbox"/> LINX2-HUFALV \$355			
		Small	<input type="checkbox"/> AXYS-HUFAML \$316	<input type="checkbox"/> ONYX-HUFAML \$316	<input type="checkbox"/> LINX-HUFAML \$316	<input type="checkbox"/> LINX2-HUFAML \$355			
		Early Intervention	<input type="checkbox"/> AXYS-HUFAMV \$316	<input type="checkbox"/> ONYX-HUFAMV \$316	<input type="checkbox"/> LINX-HUFAMV \$316	<input type="checkbox"/> LINX2-HUFAMV \$355			
			<input type="checkbox"/> AXYS-HUFASL \$316	<input type="checkbox"/> ONYX-HUFASL \$316	<input type="checkbox"/> LINX-HUFASL \$316	<input type="checkbox"/> LINX2-HUFASL \$355			
			<input type="checkbox"/> AXYS-HUFASV \$316	<input type="checkbox"/> ONYX-HUFASV \$316	<input type="checkbox"/> LINX-HUFASV \$316	<input type="checkbox"/> LINX2-HUFASV \$355			
	<b>Swing-Away Arms*</b>	Large	<input type="checkbox"/> AXYS-HUFAEIL \$316	<input type="checkbox"/> ONYX-HUFAEIL \$316	<input type="checkbox"/> LINX-HUFAEIL \$316	<input type="checkbox"/> LINX2-HUFAEIL \$355			
		Medium	<input type="checkbox"/> AXYS-HUFAEIV \$316	<input type="checkbox"/> ONYX-HUFAEIV \$316	<input type="checkbox"/> LINX-HUFAEIV \$316	<input type="checkbox"/> LINX2-HUFAEIV \$355			
		Small	<input type="checkbox"/> AXYS-HUSALL \$381	<input type="checkbox"/> ONYX-HUSALL \$381	<input type="checkbox"/> LINX-HUSALL \$381	<input type="checkbox"/> LINX2-HUSALL \$419			
		Early Intervention	<input type="checkbox"/> AXYS-HUSALV \$381	<input type="checkbox"/> ONYX-HUSALV \$381	<input type="checkbox"/> LINX-HUSALV \$381	<input type="checkbox"/> LINX2-HUSALV \$419			
			<input type="checkbox"/> AXYS-HUSAML \$381	<input type="checkbox"/> ONYX-HUSAML \$381	<input type="checkbox"/> LINX-HUSAML \$381	<input type="checkbox"/> LINX2-HUSAML \$419			
			<input type="checkbox"/> AXYS-HUSAMV \$381	<input type="checkbox"/> ONYX-HUSAMV \$381	<input type="checkbox"/> LINX-HUSAMV \$381	<input type="checkbox"/> LINX2-HUSAMV \$419			
			<input type="checkbox"/> AXYS-HUSASL \$381	<input type="checkbox"/> ONYX-HUSASL \$381	<input type="checkbox"/> LINX-HUSASL \$381	<input type="checkbox"/> LINX2-HUSASL \$419			
			<input type="checkbox"/> AXYS-HUSASV \$381	<input type="checkbox"/> ONYX-HUSASV \$381	<input type="checkbox"/> LINX-HUSASV \$381	<input type="checkbox"/> LINX2-HUSASV \$419			
			<input type="checkbox"/> AXYS-HUSAEIL \$381	<input type="checkbox"/> ONYX-HUSAEIL \$381	<input type="checkbox"/> LINX-HUSAEIL \$381	<input type="checkbox"/> LINX2-HUSAEIL \$419			
			<input type="checkbox"/> AXYS-HUSAEIV \$381	<input type="checkbox"/> ONYX-HUSAEIV \$381	<input type="checkbox"/> LINX-HUSAEIV \$381	<input type="checkbox"/> LINX2-HUSAEIV \$419			

### Head Positioning - Use HCPCS Code E0955







Whitmyer headrests come unassembled. Please add item WHITASSY001 if the dealer would like parts assembled. This is a no charge option.

		<input type="checkbox"/> Receiver must be selected on pg 2		<input type="checkbox"/> Adult - 15" <input type="checkbox"/> Peds - 11" <input type="checkbox"/> EI - 10"		<input type="checkbox"/> Adult - 15" <input type="checkbox"/> Peds - 11" <input type="checkbox"/> EI - 10"	
		<b>PAD</b>	<b>PRO</b>	<b>COBRA</b>	<b>COBRA-FB</b>		
<b>HEADS UP - COMMON SIZES</b>	<b>Fixed Arm</b>	Large	<input type="checkbox"/> PRO-HUFALL \$355	<input type="checkbox"/> COBRA-HUFALL \$568	<input type="checkbox"/> FBCOB-HUFALL \$677		
		Medium	<input type="checkbox"/> PRO-HUFALV \$355	<input type="checkbox"/> COBRA-HUFALV \$568	<input type="checkbox"/> FBCOB-HUFALV \$677		
		Small	<input type="checkbox"/> PRO-HUFAML \$355	<input type="checkbox"/> COBRA-HUFAML \$568	<input type="checkbox"/> FBCOB-HUFAML \$677		
		Early Intervention	<input type="checkbox"/> PRO-HUFAMV \$355	<input type="checkbox"/> COBRA-HUFAMV \$568	<input type="checkbox"/> FBCOB-HUFAMV \$677		
			<input type="checkbox"/> PRO-HUFASL \$355	<input type="checkbox"/> COBRA-HUFASL \$568	<input type="checkbox"/> FBCOB-HUFASL \$677		
			<input type="checkbox"/> PRO-HUFASV \$355	<input type="checkbox"/> COBRA-HUFASV \$568	<input type="checkbox"/> FBCOB-HUFASV \$677		
	<b>Swing-Away Arms*</b>	Large	<input type="checkbox"/> PRO-HUFAEIL \$355	<input type="checkbox"/> COBRA-HUFAEIL \$568	<input type="checkbox"/> FBCOB-HUFAEIL \$677		
		Medium	<input type="checkbox"/> PRO-HUFAEIV \$355	<input type="checkbox"/> COBRA-HUFAEIV \$568	<input type="checkbox"/> FBCOB-HUFAEIV \$677		
		Small	<input type="checkbox"/> PRO-HUSALL \$429	<input type="checkbox"/> COBRA-HUSALL \$644	<input type="checkbox"/> FBCOB-HUSALL \$751		
		Early Intervention	<input type="checkbox"/> PRO-HUSALV \$429	<input type="checkbox"/> COBRA-HUSALV \$644	<input type="checkbox"/> FBCOB-HUSALV \$751		
			<input type="checkbox"/> PRO-HUSAML \$429	<input type="checkbox"/> COBRA-HUSAML \$644	<input type="checkbox"/> FBCOB-HUSAML \$751		
			<input type="checkbox"/> PRO-HUSAMV \$429	<input type="checkbox"/> COBRA-HUSAMV \$644	<input type="checkbox"/> FBCOB-HUSAMV \$751		
			<input type="checkbox"/> PRO-HUSASL \$429	<input type="checkbox"/> COBRA-HUSASL \$644	<input type="checkbox"/> FBCOB-HUSASL \$751		
			<input type="checkbox"/> PRO-HUSASV \$429	<input type="checkbox"/> COBRA-HUSASV \$644	<input type="checkbox"/> FBCOB-HUSASV \$751		
			<input type="checkbox"/> PRO-HUSAEIL \$429	<input type="checkbox"/> COBRA-HUSAEIL \$644	<input type="checkbox"/> FBCOB-HUSAEIL \$751		
			<input type="checkbox"/> PRO-HUSAEIV \$429	<input type="checkbox"/> COBRA-HUSAEIV \$644	<input type="checkbox"/> FBCOB-HUSAEIV \$751		

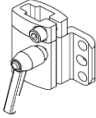
\*See Page 2 for all configurations available

**Mounting Brackets - Use HCPCS Code E1028**

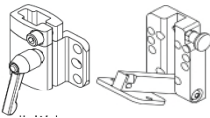

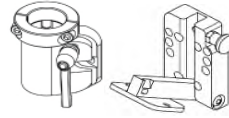
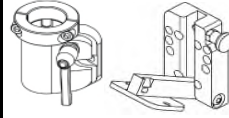



Head Support System Mounting Brackets must be ordered separately, except for COBRA

	AXYS	ONYX	LINX & LINX <sup>2</sup>	PRO	COBRA mounting system includes detachable mounting bracket	
<b>REMOVABLE MOUNTING BRACKET</b> (PART SOLD SEPARATELY FROM POST & PAD)						
<b>Detachable</b>	<input type="checkbox"/> M2500 \$113	<input type="checkbox"/> M2100-WB \$92	<input type="checkbox"/> M2300 \$177	<input type="checkbox"/> M2200-WB \$199		
<b>REMOVABLE &amp; SWING-AWAY MNT BRACKET</b> (PART SOLD SEPARATELY FROM POST & PAD)						
<b>Swing-Away</b>	<input type="checkbox"/> M5500 \$215	<input type="checkbox"/> M5100 \$199	<input type="checkbox"/> M5300 \$284	<input type="checkbox"/> M5200 \$305		

**HEADS UP - HEAD AND NECK POSITIONING SYSTEM ORDERING GUIDE**

Head Support System Mounting Brackets must be ordered separately, except for COBRA

**STEP 1: SELECT HARDWARE SYSTEM**

							
	<input type="checkbox"/> AXYS-HU-	<input type="checkbox"/> ONYX-HU-	<input type="checkbox"/> LINX-HU-	<input type="checkbox"/> LINX2-HU-	<input type="checkbox"/> PRO-HU-	<input type="checkbox"/> COBRA-HU-	<input type="checkbox"/> FBCOB-HU-
W/O OCC Pad	\$381	\$381	\$381	\$419	\$429	\$644	\$751
W/ OCC Pad	\$488	\$488	\$488	\$526	\$537	\$751	\$859

**BUILD YOUR HEADS UP SMART PART NUMBER**

<b>STEP 1</b> Enter Hardware System Part Number	
<b>STEP 2</b> Enter I, S, M, or L	
<b>STEP 3</b> Enter T or S	
<b>STEP 4</b> Enter S or L	
<b>STEP 5</b> Enter S or C	
<b>STEP 6</b> Enter L or V	
<b>STEP 7 (Optional)</b> Enter -O5, -O6, -O8, or -O10	

**STEP 2: SELECT NECK WIDTH**



<input type="checkbox"/> I = Infant 3.3" wide
<input type="checkbox"/> S = Small 4" wide
<input type="checkbox"/> M = Medium 4.6" wide
<input type="checkbox"/> L = Large 5.8" wide

**STEP 4: SELECT SWING OUT SUPPORT ARM LENGTH**



<input type="checkbox"/> S = Short
<input type="checkbox"/> L = Long
<i>Infant &amp; Small: Short = 5.63" Long = 7.25"</i>
<i>Medium &amp; Large: Short = 7" Long = 9"</i>

**STEP 5: SELECT FOAM TYPE**

<input type="checkbox"/> S = Standard
<input type="checkbox"/> C = Comfort

**STEP 6: SELECT COVER**

<input type="checkbox"/> L = Lycra Neoprene
<input type="checkbox"/> V = Dartex Reversed

**STEP 7: SELECT OPTIONAL OCC PADS**

*Available on Short Heights Only*

<input type="checkbox"/> -O5 = Pediatric 5" Pad (Short Infant Sizes)
<input type="checkbox"/> -O6 = Adult 6" Pad (Short Small Sizes)
<input type="checkbox"/> -O8 = Plush 8" Pad (Short Medium Sizes)
<input type="checkbox"/> -O10 = Plush 10" Pad (Short Large Sizes)
<input type="checkbox"/> N/A









**STEP 3: SELECT CONTOUR CRADLE HEIGHT**

**Tall**  **Short**  shown with Occipital Pad (Step 7)

<input type="checkbox"/> T = Tall
<input type="checkbox"/> S = Short

### Lateral Facial Supports

Note: Cover Selection - Add **L** = Lycra or **V** = Dartex Reversed (Example: LFC-PLL)



								
	2"	2.25" x 5"	2.25" x 7"	4" x 6"	2" x 6"	1.75" x 5"	1.25" x 4"	
	<b>SPOT</b>	<b>STANDARD</b>	<b>LONG</b>	<b>OVAL</b>	<b>LARGE-C</b>	<b>MED-C</b>	<b>SMALL-C</b>	<b>FSO-B</b>

<b>Unilateral</b>	<input type="checkbox"/>	LFC10-CSL	LFC15-CSL	LFC20-CSL	LFC25-CSL	LFC30-CSL	LFC35-CSL	LFC40-CSL	<input type="checkbox"/>	LFC80-CS LM115
		\$236	\$236	\$236	\$236	\$236	\$236	\$236		
	LM115	LM115	LM115	LM115	LM115	LM115	LM115	LM115		
	\$86	\$86	\$86	\$86	\$86	\$86	\$86	\$86		
<input type="checkbox"/>	<input type="checkbox"/>	LFC10-CSV	LFC15-CSV	LFC20-CSV	LFC25-CSV	LFC30-CSV	LFC35-CSV	LFC40-CSV	<input type="checkbox"/>	LM115
		\$236	\$236	\$236	\$236	\$236	\$236	\$236		
	LM115	LM115	LM115	LM115	LM115	LM115	LM115	LM115		
	\$86	\$86	\$86	\$86	\$86	\$86	\$86	\$86		

<b>Bilateral</b>	<input type="checkbox"/>	LFC10-CS2L	LFC15-CS2L	LFC20-CS2L	LFC25-CS2L	LFC30-CS2L	LFC35-CS2L	LFC40-CS2L	<input type="checkbox"/>	LFC80-CS2 LM115	
		\$440	\$440	\$440	\$440	\$440	\$440	\$440			
		LM115	LM115	LM115	LM115	LM115	LM115	LM115			
		\$86	\$86	\$86	\$86	\$86	\$86	\$86			
		LM115	LM115	LM115	LM115	LM115	LM115	LM115			
		\$86	\$86	\$86	\$86	\$86	\$86	\$86			
	<input type="checkbox"/>	<input type="checkbox"/>	LFC10-CS2V	LFC15-CS2V	LFC20-CS2V	LFC25-CS2V	LFC30-CS2V	LFC35-CS2V		LFC40-CS2V	LM115
			\$440	\$440	\$440	\$440	\$440	\$440		\$440	
		LM115	LM115	LM115	LM115	LM115	LM115	LM115			
		\$86	\$86	\$86	\$86	\$86	\$86	\$86			
		LM115	LM115	LM115	LM115	LM115	LM115	LM115			
		\$86	\$86	\$86	\$86	\$86	\$86	\$86			

<b>Pad Only*</b>	<input type="checkbox"/>	PL10L	PL15L	PL20L	P600L	PL30L	PL35L	PL40L	N/A
		\$76	\$107	\$107	\$107	\$107	\$107	\$97	
	PL10V	PL15V	PL20V	P600V	PL30V	PL35V	PL40V		
	\$76	\$107	\$107	\$107	\$107	\$107	\$97		

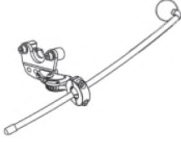
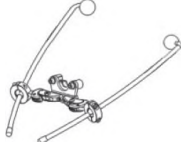
### Lateral Facial Supports

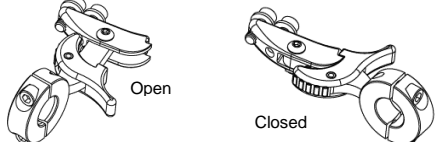

<b>MOUNTING HARDWARE</b>				
	<b>Unilateral</b>	<b>Bilateral</b>	<b>Infinity Mount</b>	<b>Swing-Away Mount</b> LM115

### LATERAL FACIAL SUPPORT PARTS

\*Note: If ordering an additional Lateral Facial Support, select both a Lateral Facial Support Pad Only from page 3 and an Infinity Mount from below as well

	Option #	Definition	Price
<input type="checkbox"/>	242161	Infinity Dual Mount Assembly*	\$209
<input type="checkbox"/>	LM1010	Lateral Facial Support*	\$135

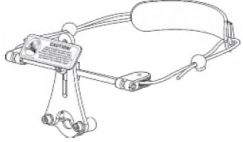
### ANTERIOR HEAD SUPPORT

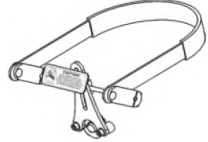
												
<b>DYNAMIC FOREHEAD STRAP</b>	<b>DFS<sup>2</sup></b>	<b>STRAP CAP</b>	<b>STATIC FOREHEAD STRAP</b>									
<b>ADULT</b>	<input type="checkbox"/>	DFS10	\$310	<input type="checkbox"/>	DFSQ10	\$375	<input type="checkbox"/>	CAP10 (black)	\$429	<input type="checkbox"/>	HU10	\$338
<b>PEDS</b>	<input type="checkbox"/>	DFS30	\$310	<input type="checkbox"/>	DFSQ30	\$375	<input type="checkbox"/>	CAP30-R (red)	\$429			
							<input type="checkbox"/>	CAP30-B (blue)	\$429			

**MOUNTING OPTIONS**

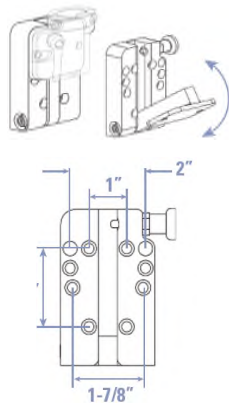
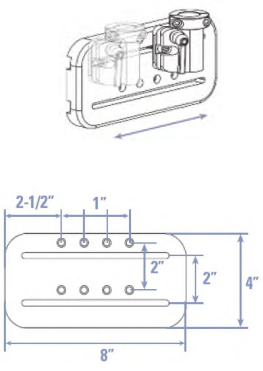
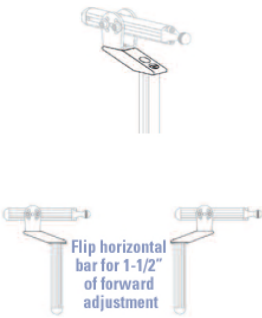
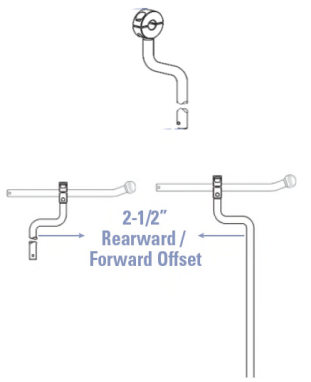
				
<p><b>FLEX INTERFACE BRACKET</b></p>	<p><b>UNIVERSAL SWING-AWAY MOUNT</b></p>	<p><b>SLIDE MOUNT</b></p>	<p><b>PRO OFF-SET MOUNTING SYSTEM</b></p>	<p><b>ONYX REARWARD OFF-SET VERTICAL ROD</b></p>

<input type="checkbox"/>	M9450 (hard)	\$199	<input type="checkbox"/>	M5000	\$107	<input type="checkbox"/>	M7010	\$102	<input type="checkbox"/>	PRC7070	\$175	<input type="checkbox"/>	OX6030	\$65
<input type="checkbox"/>	M9451 (soft)	\$199												

**TOOLS**

✓	Option #	Definition	Price
<input type="checkbox"/>	BOLT LUBE	Bolt Lube	\$8.00
<input type="checkbox"/>	T2500	Tool Kit	\$6.00

**Pad Styles**

<p><b>HEADS UP COMMON SIZES</b></p>	 <p><b>Large HU-L</b> 5.8" Neck Width 9" Long Arms Standard Foam</p>	 <p><b>Medium HU-M</b> 4.6" Neck Width 9" Long Arms Standard Foam</p>	 <p><b>Small HU-S</b> 4" Neck Width 5.6" Short Arms Standard Foam</p>	 <p><b>Early Intervention HU-I</b> 3.3" Neck Width 5.6" Short Arms Standard Foam</p>
-------------------------------------	---	--	--	---



**SUNRISE MEDICAL.**

Sunrise Medical (US) LLC  
2842 Business Park Ave. · Fresno, CA 93727 · USA