



JAY® J3 Plus Backrest

E2614

January 2022

Mark For: _____

Date: _____

Dealer Acct #: _____

Dealer: _____

Dealer Contact: _____

Dealer Address: _____

Dealer City: _____ ST: _____ ZIP: _____

Dealer Phone: () _____ Fax: () _____

Confirmation Email: _____

Confirm Via: Fax Email

Submitting for:

Quote Order

PO#: _____

ADDITIONAL SHIPPING INFORMATION

Ship To: _____

Attention: _____

Address: _____

Address: _____

Ship To City: _____ ST: _____ ZIP: _____

Ship To Phone: () _____ Fax () _____

The **HCPCS CODES** herein are based on PDAC verification or interpretation of Medicare definitions and guidelines. Non-Medicare payers may accept alternative **HCPCS CODES**, including misc. codes to ensure access for their enrollees. The use of **HCPCS CODES** does not ensure coverage or payment.

JAY J3 Plus Posterior (PA) Backrest - E2614



BACKREST WIDTH	22"	24"	26"
BACKCANE WIDTHS	22"-24"	24"-26"	26"-28"
MAX. USER TRUNK WIDTH	21"	23"	25"

Back Height	Mid Thoracic (MT)								
		12.0" (S)	J3PAMTSxxFS	<input type="checkbox"/> 22	\$853	<input type="checkbox"/> 24	\$853	<input type="checkbox"/> 26	\$853
			J3PAMTSxxTH	<input type="checkbox"/> 22	\$853	<input type="checkbox"/> 24	\$853	<input type="checkbox"/> 26	\$853
		13.5" (M)							
		15.0" (T)	J3PAMTTxxFS	<input type="checkbox"/> 22	\$853	<input type="checkbox"/> 24	\$853	<input type="checkbox"/> 26	\$853
			J3PAMTTxxTH	<input type="checkbox"/> 22	\$853	<input type="checkbox"/> 24	\$853	<input type="checkbox"/> 26	\$853
	Mid Thoracic (MT) w/ Vanity Shell Extension								
		20.0" (S)	J3PLUSPASxxFS	<input type="checkbox"/> 22	\$1,068	<input type="checkbox"/> 24	\$1,068	<input type="checkbox"/> 26	\$1,068
			J3PLUSPASxxTH	<input type="checkbox"/> 22	\$1,068	<input type="checkbox"/> 24	\$1,068	<input type="checkbox"/> 26	\$1,068
		21.5" (M)							
		23.0" (T)	J3PLUSPATxxFS	<input type="checkbox"/> 22	\$1,068	<input type="checkbox"/> 24	\$1,068	<input type="checkbox"/> 26	\$1,068
			J3PLUSPATxxTH	<input type="checkbox"/> 22	\$1,068	<input type="checkbox"/> 24	\$1,068	<input type="checkbox"/> 26	\$1,068
	Upper Thoracic (UT)								
		16.5" (S)							
		18.0" (M)	J3PAUTMxxFS	<input type="checkbox"/> 22	\$853	<input type="checkbox"/> 24	\$853		
		J3PAUTMxxTH	<input type="checkbox"/> 22	\$853	<input type="checkbox"/> 24	\$853			
	19.5" (T)								
Shoulder Height (SH)									
	21.0" (S)	J3PASHSxxFS	<input type="checkbox"/> 22	\$853					
		J3PASHSxxTH	<input type="checkbox"/> 22	\$853					
	22.5" (M)								
	24.0" (T)								

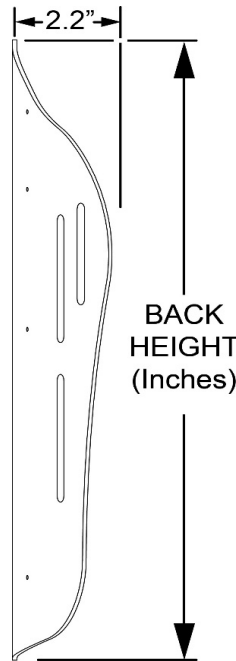

TH

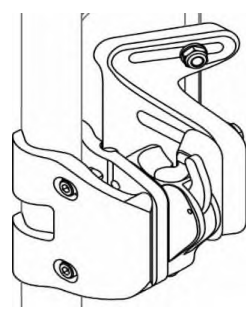

FS

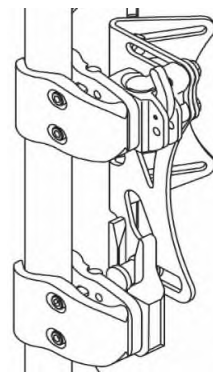

Vanity Shell Extension



MOUNTING HARDWARE OPTIONS

SHELL OPTIONS

Note: Back shells will measure 1" to 4" shorter as the material has been removed to accommodate additional tissue. (MT std -1", MT tall -2", UT med -3", SH std -4") however foam and cover will measure stated back height.

Note: Vanity Shell Extension extends the lower edge of the Mid Thoracic back shell by 8". The shell extension is equipped with dynamic hinges to allow the shell extension to easily move out of the way to discreetly cover the person sitting in the chair.

JAY J3 Back Accessories

All JAY J3 Plus Back accessories are optional. All accessories will be factory mounted as much as possible to insure proper shipping (If selected below).

SHIPPING INSTRUCTIONS

	Option #	HCPCS	Definition	Price		Option #	HCPCS	Definition	Price
<input checked="" type="checkbox"/>	N/A		Ship Back on Chair (Chair to be ordered separately)	NC	<input checked="" type="checkbox"/>	N/A		Ship accessories mounted on back	NC

Headrests

Use this section for selecting headrest. Head supports are not available on Mid Thoracic Back Shells

STEP 1

Select your HEADREST POST

Please select one box from the below **Headrest Mount & Bracket** choices.

<input type="checkbox"/>	J3HEDX	E1028	Axys Mount & Bracket	\$236.00	<input type="checkbox"/>	J3HEDO	E1028	ONYX Mount & Bracket	\$215.00
<input type="checkbox"/>	J3HEDL	E1028	LINX Mount & Bracket	\$301.00	<input type="checkbox"/>	J3HEDC	E1028	Cobra Mount & Bracket	\$301.00
<input type="checkbox"/>	J3HEDL2	E1028	LINX ² Mount & Bracket	\$333.00	<input type="checkbox"/>	J3HEDF	E1028	Cobra Flip Back Mount and Bracket	\$376.00

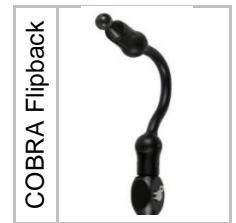
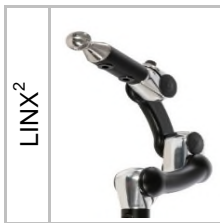
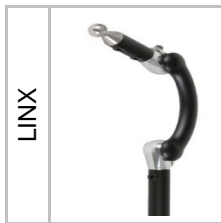

STEP 2

Select your HEADREST PAD

Please select one box from the below **Headrest Pad** choices.

<input type="checkbox"/>	14	E0955	J3PLSH14 - 14" Plush Pad	\$186.00	<input type="checkbox"/>	AAPS	E0955	J3AAPS - Adjust-A-Plush Standard (Lg)	\$279.00
<input type="checkbox"/>	10	E0955	J3PLSH10 - 10" Plush Pad	\$173.00	<input type="checkbox"/>	AAPM	E0955	J3AAPS - Adjust-A-Plush Medium	\$279.00
<input type="checkbox"/>	8	E0955	J3PLSH8 - 8" Plush Pad	\$173.00	<input type="checkbox"/>	AAPN	E0955	J3AAPS - Adjust-A-Plush Narrow (Sm)	\$279.00
<input type="checkbox"/>	HUPL	E0955	J3HUPL - HeadsUp Lrg: 5.3" Lng Arms	\$333.00	<input type="checkbox"/>	CL	E0955	J3CRDLLG - Lrg Contour Cradle Pad	\$166.00
<input type="checkbox"/>	HUPM	E0955	J3HUPM - HeadsUp Med: 4.1" Sht Arms	\$333.00	<input type="checkbox"/>	CM	E0955	J3CRDLMD - Med Contour Cradle Pad	\$154.00
<input type="checkbox"/>	HUPS	E0955	J3HUPS - HeadsUp Sml: 3.5" Sht Arms	\$333.00	<input type="checkbox"/>	PL	E0955	J3CPLULG - Large C-Plush Pad	\$166.00
					<input type="checkbox"/>	PM	E0955	J3CPLUMD - Medium C-Plush Pad	\$166.00

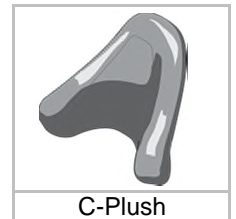
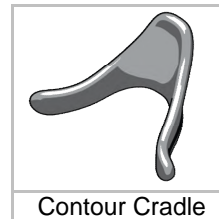
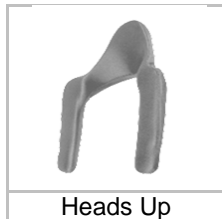
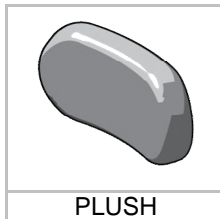

STEP 1 Headrest Post Example = J3HEDX	+	STEP 2 Headrest Pad # Example = 14	=	COMPLETED JAY J3 Headrest # Example = J3HEDX14
--	---	---	---	---

UNIVERSAL MOUNTING PLATE

<input type="checkbox"/>	J3UHM	K0108	Universal Headrest Mounting Plate Only	\$56.00
--------------------------	-------	-------	--	---------

Lateral Supports

Use this section for selecting laterals and hardware. Lateral supports are not available on Mid Thoracic Back Shells

Lateral Thoracic Support (Fixed)

Includes fixed mounting hardware. Lateral pads use 3DX covers with 1/2" Sunmate foam in the core

<input type="checkbox"/>	J3LAT4X4FX	E0956	LATERAL 4" Depth X 4" Height FIXED	\$269.00	<input type="checkbox"/>	J3LAT6X4FX	E0956	LATERAL 6" Depth X 4" Height FIXED	\$269.00
<input type="checkbox"/>	J3LAT4X5FX	E0956	LATERAL 4" Depth X 5" Height FIXED	\$269.00	<input type="checkbox"/>	J3LAT6X5FX	E0956	LATERAL 6" Depth X 5" Height FIXED	\$269.00
<input type="checkbox"/>	J3LAT4x6FX	E0956	LATERAL 4" Depth X 6" Height FIXED	\$269.00	<input type="checkbox"/>	J3LAT6X6FX	E0956	LATERAL 6" Depth X 6" Height FIXED	\$269.00

J3 Swing-Away Lateral Thoracic Support (Pairs)

<input type="checkbox"/>	J3LAT4X4SA		LAT 4X4 W/ S/A MOUNTS - PR	\$836.00	<input type="checkbox"/>	J3LAT6X4SA		LAT 6X4 W/ S/A MOUNTS - PR	\$836.00
	J3LAT4X4	E0956	LATERAL 4" Depth X 4" Height - PAIR	\$270.00		J3LAT6X4	E0956	LATERAL 6" Depth X 4" Height - PAIR	\$270.00
	J3SAMNT	E1028	LATERAL SWING AWAY MOUNT - PAIR	\$566.00		J3SAMNT	E1028	LATERAL SWING AWAY MOUNT - PAIR	\$566.00
<input type="checkbox"/>	J3LAT4X5SA		LAT 4X5 W/ S/A MOUNTS - PR	\$836.00	<input type="checkbox"/>	J3LAT6X5SA		LAT 6X5 W/ S/A MOUNTS - PR	\$836.00
	J3LAT4X5	E0956	LATERAL 4" Depth X 5" Height - PAIR	\$270.00		J3LAT6X5	E0956	LATERAL 6" Depth X 5" Height - PAIR	\$270.00
	J3SAMNT	E1028	LATERAL SWING AWAY MOUNT - PAIR	\$566.00		J3SAMNT	E1028	LATERAL SWING AWAY MOUNT - PAIR	\$566.00
<input type="checkbox"/>	J3LAT4X6SA		LAT 4X6 W/ S/A MOUNTS - PR	\$836.00	<input type="checkbox"/>	J3LAT6X6SA		LAT 6X6 W/ S/A MOUNTS - PR	\$836.00
	J3LAT4X6	E0956	LATERAL 4" Depth X 6" Height - PAIR	\$270.00		J3LAT6X6	E0956	LATERAL 6" Depth X 6" Height - PAIR	\$270.00
	J3SAMNT	E1028	LATERAL SWING AWAY MOUNT - PAIR	\$566.00		J3SAMNT	E1028	LATERAL SWING AWAY MOUNT - PAIR	\$566.00

NEW! Swing-Away Lateral Thoracic Support

Includes: Swing-away mounting hardware, left and right lateral are independent. Different types and sizes can be selected for each side.

Left Side

<input type="checkbox"/>	JLATSA44L		LAT 4X4 W/ S/A MOUNTS - LH	\$418.00
	JLAT4X4	E0956	Lateral 4" Depth X 4" Height	\$135.00
	JSAMNTL	E1028	Lateral Swing Away Mount - Left	\$283.00
<input type="checkbox"/>	JLATSA45L		LAT 4X5 W/ S/A MOUNTS - LH	\$418.00
	JLAT4X5	E0956	LATERAL 4" Depth X 5" Height	\$135.00
	JSAMNTRL	E1028	Lateral Swing Away Mount - Left	\$283.00
<input type="checkbox"/>	JLATSA46L		LAT 4X6 W/ S/A MOUNTS - LH	\$418.00
	JLAT4X6	E0956	LATERAL 4" Depth X 6" Height	\$135.00
	JSAMNTL	E1028	Lateral Swing Away Mount - Left	\$283.00
<input type="checkbox"/>	JLATSA64L		LAT 6X4 W/ S/A MOUNTS - LH	\$418.00
	JLAT6X4	E0956	LATERAL 6" Depth X 4" Height	\$135.00
	JSAMNTL	E1028	Lateral Swing Away Mount - Left	\$283.00
<input type="checkbox"/>	JLATSA65L		LAT 6X5 W/ S/A MOUNTS - LH	\$418.00
	JLAT6X5	E0956	LATERAL 6" Depth X 5" Height	\$135.00
	JSAMNTL	E1028	Lateral Swing Away Mount - Left	\$283.00
<input type="checkbox"/>	JLATSA66L		LAT 6X6 W/ S/A MOUNTS - LH	\$418.00
	JLAT6X6	E0956	LATERAL 6" Depth X 6" Height	\$135.00
	JSAMNTL	E1028	Lateral Swing Away Mount - Left	\$283.00

Right Side

<input type="checkbox"/>	JLATSA44R		LAT 4X4 W/ S/A MOUNTS - RH	\$418.00
	JLAT4X4	E0956	Lateral 4" Depth X 4" Height	\$135.00
	JSAMNTR	E1028	Lateral Swing Away Mount - Right	\$283.00
<input type="checkbox"/>	JLATSA45R		LAT 4X5 W/ S/A MOUNTS - RH	\$283.00
	JLAT4X5	E0956	Lateral 4" Depth X 5" Height	\$135.00
	JSAMNTR	E1028	Lateral Swing Away Mount - Right	\$283.00
<input type="checkbox"/>	JLATSA46R		LAT 4X6 W/ S/A MOUNTS - RH	\$418.00
	JLAT4X6	E0956	Lateral 4" Depth X 6" Height	\$135.00
	JSAMNTR	E1028	Lateral Swing Away Mount - Right	\$283.00
<input type="checkbox"/>	JLATSA64R		LAT 6X4 W/ S/A MOUNTS - RH	\$418.00
	JLAT6X4	E0956	Lateral 6" Depth X 4" Height	\$135.00
	JSAMNTR	E1028	Lateral Swing Away Mount - Right	\$283.00
<input type="checkbox"/>	JLATSA65R		LAT 6X5 W/ S/A MOUNTS - RH	\$418.00
	JLAT6X5	E0956	Lateral 6" Depth X 5" Height	\$135.00
	JSAMNTR	E1028	Lateral Swing Away Mount - Right	\$283.00
<input type="checkbox"/>	JLATSA66R		LAT 6X6 W/ S/A MOUNTS - RH	\$418.00
	JLAT6X6	E0956	Lateral 6" Depth X 6" Height	\$135.00
	JSAMNTR	E1028	Lateral Swing Away Mount - Right	\$283.00

Spine-Align Positioning Componets

J3 Plus Backs come standard with a small and large lumbar.

SPINE-ALIGN MINI FIT KIT 1

Includes: 3 wedges, 2 lateral shims, and 2 posterior/lateral pelvic positioning pads.

<input type="checkbox"/>	J3SPNK122	K0108	SPINE-ALIGN MINI FIT KIT 1 (22"-26")	\$108.00
--------------------------	-----------	-------	--------------------------------------	----------

LARGE LUMBAR PADS (Back Width) (W" x H" x D")

<input type="checkbox"/>	J3SPNLL22	K0108	LG LUMBAR (22"-26") (9.5" x 7" x 1.6")	\$47.00
--------------------------	-----------	-------	--	---------

WEDGES (Back Width) (W" x H" x D")

<input type="checkbox"/>	J3SPNWE22	K0108	WEDGES (22"-26") (9.5" x 6.5" x 1.6")	\$35.00
--------------------------	-----------	-------	---------------------------------------	---------

SPINE-ALIGN MINI FIT KIT 2

Includes: 5 wedges, 2 lat shims, 2 post/lat pelvic, 1 lg lumbar, 1 flat shim, and 1 curved









<input type="checkbox"/>	J3SPNK222	K0108	SPINE-ALIGN MINI FIT KIT 2 (22"-26")	\$149.00
--------------------------	-----------	-------	--------------------------------------	----------

SMALL LUMBAR PADS (Back Width) (W" x H" x D")

<input type="checkbox"/>	J3SPNSL22	K0108	SML LUMBAR (22"-26") (9.5" x 4.3" x 1")	\$45.00
--------------------------	-----------	-------	---	---------

OTHER INDIVIDUAL SPINE-ALIGN COMPONENTS

<input type="checkbox"/>	J3SPNCR	K0108	Curved Shim	\$26.00
<input type="checkbox"/>	J3SPNBS	K0108	Small Bean Bag	\$29.00
<input type="checkbox"/>	J3SPNFL	K0108	Flat Shim	\$26.00
<input type="checkbox"/>	J3SPNBL	K0108	Large Bean Bag	\$32.00
<input type="checkbox"/>	J3SPNLS	K0108	Lateral Shim	\$51.00
<input type="checkbox"/>	J3SPNLP	K0108	Posterior/Lateral Pelvic	\$51.00

									
	Sm Lumbar	Lg Lumbar	Wedge	Curved Slim	Flat	Lateral Slim	Sm Bean Bag	Lg Bean Bag	Post/Lat Pelvic
W	9.5"	9.5"	9.5"	10"	10"	2.4"	6"	10"	5.3"
H	4.3"	7"	6.5"	4"	4"	4.3"	4.5"	3.2"	3.6"
D	1"	1.6"	1.6"	0.5"	0.3"	0.5"	0.75"	0.75"	0.75"

Chest Straps, Harnesses and Brackets

Use this section for selecting harnesses. Harnesses are not available on Mid Thoracic Back Shells

CHEST STRAPS & HARNESSSES (Includes strap guides & mounting hardware)

<input type="checkbox"/>	J3HRNCOL	E0960	Center Opening w/ Buckle (Lrg)	\$163.00	<input type="checkbox"/>	J3HRNTDL	E0960	Contoured-Dynamic Pull Down (Lrg)	\$163.00
<input type="checkbox"/>	J3HRNCOX	E0960	Center Opening w/ Buckle (X-Lrg)	\$163.00	<input type="checkbox"/>	J3HRNTDX	E0960	Contoured-Dynamic Pull Down (X-Lrg)	\$163.00
<input type="checkbox"/>	J3HRNCDL	E0960	Classic-Dynamic Pull Down (Lrg)	\$163.00	<input type="checkbox"/>	J3HRNTSL	E0960	Contoured-Structured Pull Down (Lrg)	\$163.00
<input type="checkbox"/>	J3HRNCDX	E0960	Classic-Dynamic Pull Down (X-Lrg)	\$163.00	<input type="checkbox"/>	J3HRNTSX	E0960	Contoured-Structured Pull Down (XL)	\$163.00
<input type="checkbox"/>	J3HRNCSL	E0960	Classic-Structured Pull Down (Lrg)	\$163.00	<input type="checkbox"/>	J3HRNPSL	E0960	Padded Anterior Trunk Straps (Lrg)	\$152.00
<input type="checkbox"/>	J3HRNCSX	E0960	Classic-Structured Pull Down (X-Lrg)	\$163.00	<input type="checkbox"/>	J3HRNPSX	E0960	Padded Anterior Trunk Straps (X-Lrg)	\$152.00

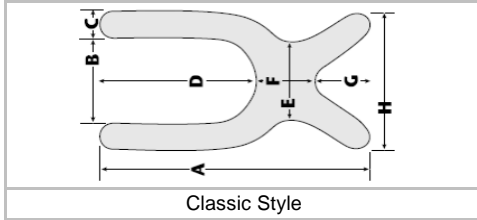

Classic Style

	A	B	C	D	E	F	G	H
L	22.5"	6.5"	2"	13"	6"	6"	3.5"	10.5"
XL	25.5"	6.5"	2.5"	14"	7"	7"	4.5"	11.5"

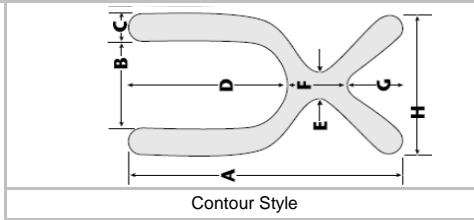

Contour Style

	A	B	C	D	E	F	G	H
L	22.5"	6.5"	2"	13"	1.5"	6"	3.5"	10.5"
XL	25.5"	6.5"	2.5"	14"	1.5"	7"	4.5"	11.5"

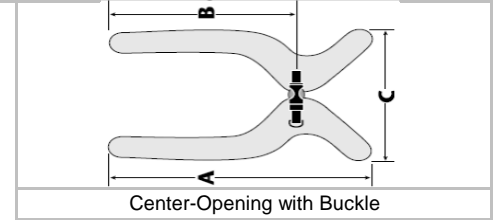

Center-Opening with Buckle

	A	B	C
L	15.5"	11.5"	9.8"
XL	17.5"	12.8"	10"

GUIDE BRACKETS & HARDWARE ONLY

<input type="checkbox"/>	J3GPSG	K0108	Guide Brackets Only - Pair	\$44.00	<input type="checkbox"/>	J3HHP	K0108	Hardware Pack Only	\$21
--------------------------	--------	-------	----------------------------	---------	--------------------------	-------	-------	--------------------	------

VANITY FLAP

All J3 Plus Backs ship standard with the vanity flap except J3 Plus Backs with the Vanity Shell Extension

<input type="checkbox"/>	117100	K0108	20" to 22" Wide	\$48.00	<input type="checkbox"/>	117102	K0108	24" to 26" Wide	\$48.00
<input type="checkbox"/>	117101	K0108	22" to 24" Wide	\$48.00	<input type="checkbox"/>	117103	K0108	26" to 28" Wide	\$48.00

JAY YOUR WAY MODIFICATIONS

To order sizes offered via JAY Your Way add a "M" to the front of the part number and follow the prompts.

For additional modifications visit www.sunrisemedical.com.

PAINTED BACK SHELL

<input type="checkbox"/>	SBC	Painted Back Shell	NC
Color:		<input type="checkbox"/> Match Quickie or Zippie Frame Color	

Note: Backshells can be painted any Quickie or Zippie Frame color at no charge please specify the desired color in the NOTES box below. For a full listing of frame colors available please visit www.sunrisemedical.com

MILITARY SERVICE PATCHES

<input type="checkbox"/>	VAPH	Purple Heart Service Patch	NC
<input type="checkbox"/>	VAM	Marine Service Patch	NC
<input type="checkbox"/>	VAA	Army Service Patch	NC
<input type="checkbox"/>	VAAF	Air Force Service Patch	NC
<input type="checkbox"/>	VAN	Navy Service Patch	NC
<input type="checkbox"/>	VACG	Coast Guard Service Patch	NC

EMBROIDERY

<input type="checkbox"/>	EMBROIDERY	K0108	Embroidery (32 Character Max)	\$23.00
Location:		<input type="checkbox"/> Front		
Font:		<input type="checkbox"/> Block	<input type="checkbox"/> Script	
Embroidery Text:				
Embroidery Color:				

COVER OPTIONS - Contact Surface

<input type="checkbox"/>	DBS	Dartex Back Surface	NC
<input type="checkbox"/>	3DXBS	3DX Back Surface	NC
<input type="checkbox"/>	RDBS	Reverse Dartex Back Surface	NC

COVER OPTIONS - Rear Center Flap

<input type="checkbox"/>	DCC	Digital Camouflage Cover	NC
<input type="checkbox"/>	CBC	Black Cover	NC
<input type="checkbox"/>	CBCI	Black Incontinence Cover	NC

SPINAL FLUID PAD

<input type="checkbox"/>	SFPS	Small Spinal Fluid Pad (16")	\$54.00
<input type="checkbox"/>	SFPM	Medium Spinal Fluid Pad (18")	\$54.00
<input type="checkbox"/>	SFPT	Tall Spinal Fluid Pad (20")	\$54.00
<input type="checkbox"/>	SFPXT	Extra Tall Spinal Fluid Pad (23")	\$54.00

VISCO FOAM INSERT

<input type="checkbox"/>	VF	Visco Foam Insert	\$54.00
<input type="checkbox"/>	SR	Scapular Relief Cut	\$26.00
<input type="checkbox"/>	VFWSR	Visco Foam Insert with Spinal Relief	\$54.00

Note: 2 Layers of 1" Yellow Visco foam is utilized as standard. Different colors of Visco foam can be utilized just list desired color in notes below.

Don't see the option you want? NO PROBLEM! Write your request below and we can evaluate it and provide a quote.

Notes: