

AI

ALUMINIUM 7020



CE

Customer Contact Details

Customer Name: _____

Advisor: _____

Address: _____

Phone: _____

Email: _____

Ship to Customer Address:

Shipping Name: _____

Shipping Address: _____

Phone: _____

Email: _____

Additional InformationNotes: _____

Current Wheelchair: _____

Customer Weight: _____

Customer Height: _____

Customer Disability: _____

OtherVAT Exemption Declaration (UK Only):

I declare that I am chronically sick or disabled by reason of:

and that I am receiving from RGK Wheelchairs Ltd, the wheelchair specified
herein and I claim relief from Value Added Tax under group 12 of schedule 8 to
Value Added Tax Act 1994.

Signature: _____ Date: _____

RGK Contact Authorisation:From time to time, RGK would like to send you exclusive information, news and
offers on everything RGK, by email or post. We will not pass any of your details
to any third party.I would like to be contacted by RGK:

Signature: _____ Date: _____

SERIAL NO: _____

Guide: Base product Required option Optional Extra Critical Information Information Needed

PRODUCT STYLE

- ECAXZ010 ELITE CX**
\$7,523.00
- XA600 Heat treated frame
- ECAXA062 Standard
- ECAXA063 Standard with 25mm seatrail
\$66.00
- ECAXA280 Heavy duty upgrade
\$530.00 *(Spinergy R10 wheels also required)*



Max User Weight 125kg (275lbs)

PLEASE NOTE: ALL RGK CHAIRS ARE HAND BUILT AND HAVE A MANUFACTURING MEASUREMENT TOLERANCE OF +/- 5MM

CAD APPROVAL

- | | |
|--|---|
| <ul style="list-style-type: none"> <input type="checkbox"/> XW009 QUOTE ONLY (NO CAD FOR APPROVAL)
\$0.00 <input type="checkbox"/> XW012 QUOTE CAD drawing for approval
\$405.00 (2 customer amendments ONLY) | <ul style="list-style-type: none"> <input type="checkbox"/> XW011 ORDER (NO CAD FOR APPROVAL)
\$0.00 <input type="checkbox"/> XW010 ORDER CAD drawing for approval
\$250.00 (2 customer amendments ONLY) |
|--|---|

KEY FRAME MEASUREMENTS

- XY010 Seat width *(Inside to inside of sideguards)*
 mm *(Max - 390mm) (Min=270mm)*
Select CX shell width (optional)
 A-330mm XY010 = 270-315 C-380mm XY010 = 320-365
 B-355mm XY010 = 295-340 D-405mm XY010 = 345-390
Hard foam will be used to get Seat width

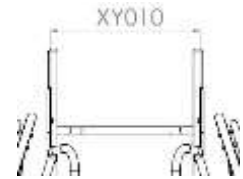

Note: CX Shell Seat Taper

Seat Taper	Seat length (mm)				
	250	300	350	400	
Seat width (mm)	330	305	280	255	230
	355	330	305	280	255
	380	355	330	305	280
	405	380	355	330	305

- XY020 Seat length
 mm Std = 20mm less than seat upholstery
(Max - 500mm)

- XY030 Extra seat length *(Provides additional leg support & hand grip)*
 mm

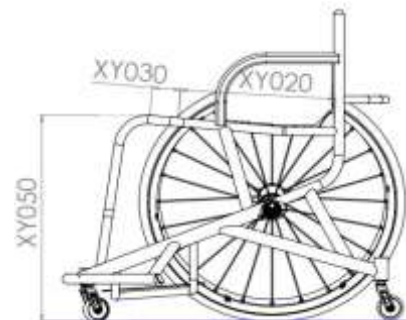

- ECAXY050 Front seat height *(Floor to middle of seat without cushion)*
 mm *(Max - 630mm) (Min - 360mm)*

- ECAXY060 Rear seat height *(Floor to middle of seat without cushion)*
 mm *(Max - 630mm) (Min - 360mm)*



- XY070 Frame length
 mm *(Min = XY020 + XY030 + 140mm)*

FRONT FRAME

XY080 Seat taper design

i Specify taper width
 mm



FOOTREST

Footrest Type

EXAXB080 Fixed position footrest

ECAXB145 Multi position footrest tubes
 \$135.00



Footrest Measurements

Front footrest height
 mm (min = 35mm)



Footrest width
 mm (Std = 200mm)

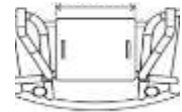

Rear footrest height
 mm (min = 35mm)



Footrest length
 mm (Std = 250mm)

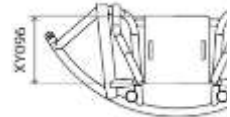

Footrest position
 (front of footplate to castor pot)
 mm

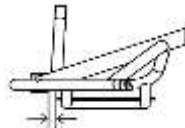

Footrest Plate

XB190 Carbon fibre footplate
 \$211.00

XB100 ABS moulded foot tray
 \$124.00

ECAXB140 Spacer kit
 \$17.00 (Allows for 25mm increase in height)

i Specify length
 mm (Max = 380mm (Full) Std = 330mm)

Footrest Plate Options

XB240 Aluminium raised edges
 \$72.00 (Cost per Edge)

Front Back Left Right

Specify height
 (Max = 60mm)

XB250 Carbon Fibre raised edge
 \$279.00 (1 side only)

Front Back

Specify height
 (Max = 45mm)

Castor Pin Width

XY330 Castor pin width

! mm **MAX 320mm**

Optimise measurements

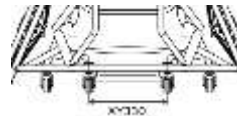

CAMBER BAR, WING AND ANTI-TIP

Centre of Gravity and Camber Angle

ECAXY510 Fixed centre of gravity



Specify measurement
 mm

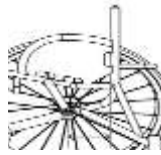

XY390 Camber angle



18 20

Wing Options (Choose one)

ECAXA110 Round design basketball wing

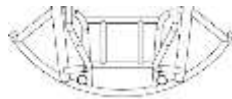

ECAXA125 Arrow design basketball wing
\$169.00

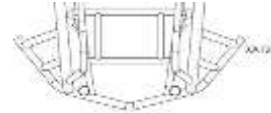

ECAXA120 Straight sided design basketball wing
\$169.00

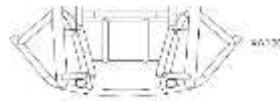

Anti-tip options (Choose one)

ECAXJ040 Single fixed anti tip

ECAXJ060 Double fixed anti tip
\$239.00

CX SIDES

Side Measurements

Sideguard height
(std = 150mm)(follow tyre)(Max = 180)



mm



Backrest depth
(std = 120mm)(Max = 150)



mm

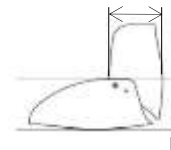

Individual Shape

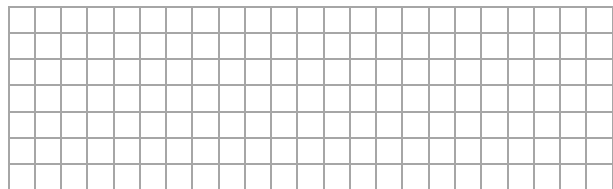
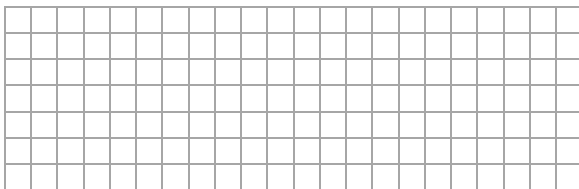

BACKREST

Backrest Height (Choose One)

XY230 Fixed backrest height



Specify height
 mm

Backrest depth **top**
(distance from front of back post to middle of upholstery)

mm

Backrest depth **bottom**
(distance from front of back post to middle of upholstery)

mm

Note: Take measurement from existing chair

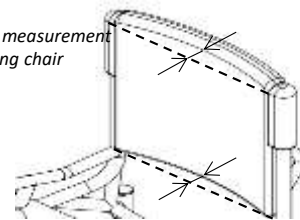

CASTOR AND REAR WHEELS

Castor Options

- | | |
|--|---|
| <input checked="" type="checkbox"/> XC160 Sport 61mm castor
(Black) | <input type="checkbox"/> XC181 Bones Reds bearings
(All castor bearings) |
| <input checked="" type="checkbox"/> XC200 Sport micro fork | <input type="checkbox"/> XC182 Bones Swiss Ceramic bearings
(All castor bearings)
\$267.00 |

Rear Wheel Size

- | | | | |
|---|---|---|--|
| <input type="checkbox"/> XY420 24" Wheels | <input type="checkbox"/> XY430 25" Wheels | <input type="checkbox"/> XY440 26" Wheels | <input type="checkbox"/> XY450 700C Wheels |
|---|---|---|--|

Rear Wheel Gap

<input type="checkbox"/> XY460 Rear wheel gap		<input type="checkbox"/> XY470 Inside to inside of wheel	
<input type="checkbox"/> 15 <input type="checkbox"/> 20 <input type="checkbox"/> 25 <input type="checkbox"/> 30 Individual <input type="text" value="mm"/>		OR	<input type="text" value="mm"/>

Rear Wheel Options

- | | |
|---|--|
| <input type="checkbox"/> XK080 Spinergy SLX 24 spoke
\$721.00 | <input type="checkbox"/> XK330 Spinergy SLX R10 heavy duty 24 spoke
\$1,332.00 (18 deg camber angle only) |
| <input type="checkbox"/> XK101 Spinergy XSLX 24 spoke + Caps
\$791.00 | <input type="checkbox"/> XK521 Spinergy Ceramic bearing upgrade
\$242.00 |

Spinergy Colour Options:

- | | | |
|--|--|--|
| <input type="checkbox"/> Black spokes | <input type="checkbox"/> White spokes | <input type="checkbox"/> Yellow spokes |
| <input type="checkbox"/> Red spokes | <input type="checkbox"/> Blue spokes | <input type="checkbox"/> Pink spokes |
| <input type="checkbox"/> Purple spokes | <input type="checkbox"/> Orange spokes | <input type="checkbox"/> Green spokes |

- | | |
|---|----------------|
| <input type="checkbox"/> XK180 Individual spoke design
\$169.00 | Inside: _____ |
| | Outside: _____ |

Spinergy Anodise Options

- | | | | |
|---|---|---|--|
| <input type="checkbox"/> XK190 Black hub
(std option) | <input type="checkbox"/> XK200 Silver hub
\$88.00 | <input type="checkbox"/> XK201 Red hub/rims
\$263.00 | <input type="checkbox"/> XK205 Individual hub/rims
\$304.00 Select colour: _____ |
| <input type="checkbox"/> XK202 Purple hub/rims
\$263.00 | <input type="checkbox"/> XK203 Blue hub/rims
\$263.00 | <input type="checkbox"/> XK204 Gold hub/rims
\$263.00 | |

Supply Without Wheels

- | | | |
|--|----------------------------------|---------------------------------|
| <input type="checkbox"/> XK040 Supply without Wheels
-\$177.00 | Wheel Type: <input type="text"/> | Tyre Type: <input type="text"/> |
|--|----------------------------------|---------------------------------|

Handrim Position / Options

- | | |
|---|---|
| <input type="checkbox"/> XY480 Narrow set handrim | <input type="checkbox"/> XY485 Wide set handrim |
| <input type="checkbox"/> XL090 Remove excess mounting tabs
\$94.00 (recommended for small wheel gaps) | <input type="checkbox"/> XL080 Super narrow set handrim
\$195.00 (only with XL040 and includes XL090) |

Handrim Style

- | | |
|--|--|
| <input type="checkbox"/> XL010 Aluminium hard anodised 6 tab | <input type="checkbox"/> XL040 Titanium 6 tab
\$231.00 (Not with 700C) |
| <input type="checkbox"/> XL070 Aluminium hard anodised 12 tab
\$97.00 (24" not available) | <input type="checkbox"/> XL050 Stainless steel 6 tab
\$127.00 |

Tyre Options

- | | | |
|--|--|---|
| <input type="checkbox"/> XM070 Kenda Kaliente | <input type="checkbox"/> Red <input type="checkbox"/> Blue | <input type="checkbox"/> XM095 Kenda Wide
\$34.00 (Grey Only) |
| <input type="checkbox"/> XM150 IRC Exeracer Pro
\$80.00 (Red Only) | | |
| <input type="checkbox"/> XM080 Tufo MS3 tubeless
\$80.00 (Blue only) | | |

Spare Wheel

- | | |
|---|---|
| <input type="checkbox"/> ELAXK500 Spare wheel Spinergy
\$812.00 (Built up + axle pin) | <input type="checkbox"/> XK523 Spare wheel upcharge - Individual Hubs/Rims
\$117.00 |
| <input type="checkbox"/> XK520 Spare wheel upcharge - Titanium Rims
\$189.00 | <input type="checkbox"/> XK524 Spare wheel upcharge - Individual Spoke Colour
\$85.00 |
| <input type="checkbox"/> XK522 Spare wheel upcharge - Remove Excess Tabs
\$49.00 | |

Inner Tube Valve Options

- | | |
|---|---|
| <input type="checkbox"/> XY500 Schraeder inner tube valve | <input type="checkbox"/> XY490 Presta inner tube valve
(Standard if no option selected) |
|---|---|

FINISH OPTIONS

Frame finish

XN010 Powder coated frame

Frame **Gloss**

- Black gloss 103
- White gloss 100
- Grey gloss 132
- Cream gloss 135
- Red gloss 108
- Yellow gloss 120
- Forest green gloss 143
- Green gloss 107
- Dark blue gloss 151
- Royal blue gloss 154
- Blue gloss 174
- Duckegg blue gloss 141
- Pink gloss 188
- Orange gloss 180
- Purple gloss 157

Frame **Matt**

- Black matt 105
- White matt 101
- Grey matt 131
- Light grey matt 133
- Navy blue matt 152

Frame **Special**

- Chrome Mirror 300
- Sparkle silver 170
- Metallic black matt 104
- Metallic grey matt 130
- Black sandpaper 201
- Grey sandpaper 202
- White sandpaper 200

XN200 Individual paint colour (State Colour/RAL code)
\$165.00

EXAXN030 Brushed frame
\$334.00

EXAXN050 Polished frame
\$884.00

Accent Colour

Note: Accent colour includes, forks, castor caps, and decals.

- Black accent
- Red accent
- Purple accent
- Silver accent
- Blue accent

XN250 Individual accent
\$165.00

Select Colour:

CUSHION

Cushion foam options

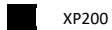

XP200 CX seat and backrest upholstery

Seat cushion foam thickness

7mm
 10mm
 25mm
 50mm
 Individual thickness

Backrest foam thickness

7mm
 10mm
 25mm
 50mm
 Individual thickness

Indicate Max Height:

580mm
 630mm

Seat cushion foam type

Soft
 Med
 Hard
 Plastazote

Backrest foam type

Soft
 Med
 Hard
 Plastazote

STRAPPING

Velcro straps

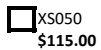

100mm Pro adjustable velcro strap

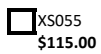

50mm Pro adjustable velcro strap

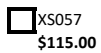

50mm Pro adjustable velcro **Knee** strap
(measurement from tube to tube over knees)

Velcro strap position

Strap 1

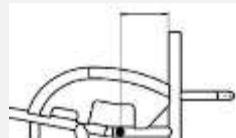
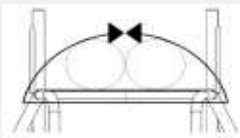

Specify strap length

Specify distance from back post

Strap 2

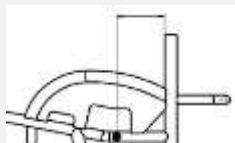
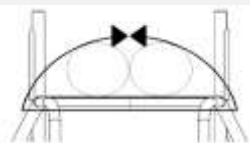

Specify strap length

Specify distance from back post

Ratchet Straps



Sport ratchet strap (Click strap)
(11" x 2" pad)



Sport ratchet strap (Single)



Pelvi Loc 2DA ratchet strap
(For thighs and knees)

Select size:

Medium (12")
 Large (14")



Pelvi Loc 3DA ratchet strap
(For hips)

Select size:

S (8")
 M (12")
 L (14")
 XL (17")



M2 ratchet strap
(For thighs and knees)

8"
 10"
 12"



M2 ratchet strap (Single)
(For Feet)

8"
 10"
 12"

Ratchet strap position

Strap 1

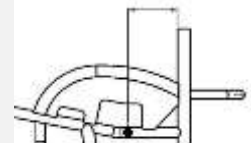

Specify distance from back post

Strap 2



Specify distance from back post



Fixed mounting points
(one set per click strap)

x1
 x2
 x3

FRAME OPTIONS



Calf strap mounting loops



Strap location loops



ACCESSORIES



Triple wheel bag
(Black)



Frame protectors full length



Plastic tube fitted to offensive wing



Foot strap (select if required)



Calf strap (select if required)



Back bar protector



Tool kit

ADDITIONAL NOTES

