



Quickie Pulse™ 6 Single Power Tilt Seating

K0856, K0011
EIPW22

Account: _____	Ship To: _____
Date: _____	Name: _____
PO#: _____	Address: _____
Buyer: _____	City, State, Zip: _____
Marked For: _____	Phone: _____

The HCPCS CODES herein are based on PDAC verification or interpretation of Medicare definitions and guidelines. Non-Medicare payers may accept alternative HCPCS CODES, including misc. codes to ensure access for their enrollees. The use of HCPCS CODES does not ensure coverage or payment.

✓	Option #	HCPCS	Definition	Price	✓	Option #	HCPCS	Definition	Price
---	----------	-------	------------	-------	---	----------	-------	------------	-------

1. QUICKIE Pulse™ 6 GROUP 3 CATEGORY

QUICKIE Pulse™ 6 SC (Group 3 K0856, K0011)

<input type="checkbox"/>	Quickie Pulse™ 6 SC for Tilt (Fig 1.1)		\$7,927.00
<input type="checkbox"/>	195PC76	K0856 / K0011 Base Package	\$7,927.00

SC Seating Specifications

HCPC Code	K0856 / K0011		
Typical Chair Weight	W/battery	260lbs	W/O Battery 182lbs
Transit	ISO occupied approved		
Seat Type	ASAP II		
Seat size range	Width	12"-22"	Depth 12"-22"
STFH range	ASAP II	17.5" -21.5"	
Power Seating	50° CG tilt		

Actuators Required by Power Seating Function

50° CG tilt	1 actuator
Power Leg Function (Centermount or Swing away):	2 actuators
Combination ; Tilt and Power Elevating Legrest. (Centermount or Swing away):	3 actuators



1.1 Pulse™ SC

QUICKIE Pulse™ 6 Base Specifications

Drive Wheel Position	Midwheel Drive			Drive Wheels	13" Drive Wheels w/ flat free insert (Black)
User weight Cap	300 lb			Tires/Casters	7" Front / 6" rear (Black)
Base size	Width	24"	Length	34"	Turn Radius 18"
Drive Control	VR-2 90A (non-expand)		R-net EL90 (Expandable)		
Driving Range	Up to 13.5 miles				
Drive Motors	4-pole 6 mph				
Charger	8A Dual Mode Charger (Compact) CTE				
Battery Size	Group 22				
Shroud Colors	12 standard colors, 6 upgrade prints.				
Ground Clearance	3"				

2. BASE CHAIR OPTIONS

Shroud Color				
<input type="checkbox"/>	195EZ01	-	Candy Apple Red	N/C
<input type="checkbox"/>	195EZ02	-	High Gloss Black	N/C
<input type="checkbox"/>	195EZ03	-	Candy Blue	N/C
<input type="checkbox"/>	195EZ04	-	Silver	N/C
<input type="checkbox"/>	195EZ05	-	Copper	N/C
<input type="checkbox"/>	195EZ08	-	Green Apple	N/C
<input type="checkbox"/>	195EZ09	-	Yellow	N/C
<input type="checkbox"/>	195EZ10	-	Pearl Pink	N/C
<input type="checkbox"/>	195EZ11	-	Candy Purple	N/C
<input type="checkbox"/>	195EZ12	-	Matte Black	N/C
<input type="checkbox"/>	195EZ13	-	Midnight Blue	N/C
<input type="checkbox"/>	195EZ15	-	Pearl White	N/C
<input type="checkbox"/>	195EZ06	-	Digital Camo.	\$553.00
<input type="checkbox"/>	195EZ07	-	Woodland Camo.	\$553.00
<input type="checkbox"/>	195EZ14	-	Carbon Fiber Print	\$553.00
<input type="checkbox"/>	195EZ17	-	Pink Camo	\$553.00
<input type="checkbox"/>	195EZ18	-	Grunge Skulls	\$553.00
<input type="checkbox"/>	195EZ16	-	American Flag	\$553.00

Drive wheel/tire package				
<input type="checkbox"/>	195DW60	-	Cast Wheel Solid Dual Density Inserts Black Knobby Tires and Black Casters	Std

User weight				
<input type="checkbox"/>	195WG06	-	< 150lb.	N/C
<input type="checkbox"/>	195WG13	-	151-200lb	N/C
<input type="checkbox"/>	195WG14	-	201-250lb	N/C
<input type="checkbox"/>	195WG03	-	251-300lb	N/C

Ventilator Options				
<i>Not available w/ Transit, Power Legs</i>				
<input type="checkbox"/>	195VT4	E1029	Fixed Vent Tray (Pulmonetic LTV Models)	\$499.00

Motor Package				
<input type="checkbox"/>	195PF88	-	300lbs 6mph 4-Pole	Std

Transit Option				
<input type="checkbox"/>	195TO40	-	Omit Transit	NC
<input type="checkbox"/>	195TO25	-	ISO Transit Package for use with ASAPII seating.	\$350.00

Pre-Set Seat Frame Angle				
<input type="checkbox"/>	195FA10	-	0°	N/C
<input type="checkbox"/>	195FA3	-	3° NA with +3" or +4" STFH	N/C

Seat Height				
<i>(Measured in the front) - Obtain Quote to verify est. STFH</i>				
<input type="checkbox"/>	195HT44		Position "0"	NC
<input type="checkbox"/>	195HT45		+1" Seat to Floor Height	NC
<input type="checkbox"/>	195HT46		+2" Seat to Floor Height	NC
<input type="checkbox"/>	195HT47		+3" Seat to Floor Height	NC
<input type="checkbox"/>	195HT48		+4" Seat to Floor Height	NC

STFH Matrix					
Seating Type and Power Option Combinations	Seat-to-Floor Height at 0 tilt				
	Low	+1"	+2"	+3"	+4"
SC ASAP II Tilt only	17.6"	18.6"	19.6"	20.6"	21.6"
STFH measured with batteries but no user. Actual STFH may vary by .5" *Adding seat angle will increase STFH by 1" for each incremental change. **Ultra low STFH may cause ground clearance of Power Centermount to drop below 2".					

3. BATTERIES and CHARGERS

Batteries				
<input type="checkbox"/>	195AG21	E2361	GP22 Flat Top Batteries Pair w/strap	\$564.00
<input type="checkbox"/>	195AG05	-	Omit batteries (Includes harness)	N/C

Battery Charger				
<input type="checkbox"/>	195BJ19	-	8A Dual Mode Charger (Compact) CTE	N/C

4. ELECTRONICS

Drive Control Options			
Non-Expandable Controllers			
<input type="checkbox"/>	195ER01	-	Non-expandable VR2-90 controller (For Use with 1 Thru-drive seat Function) N/C
<input type="checkbox"/>	195ER09	-	Non-expandable R-net controller (For use of Tilt and PowerCentermount) N/C

VR2 Joystick			
<input type="checkbox"/>	195J94	-	Non Expandable VR2 Joystick N/C

Expandable Controllers			
<input type="checkbox"/>	195ER02	R-Net Expandable Drive Control Upgrade (90A) \$1,053.00	
	195EX01	E2377	Expandable Controller - R-net \$580.00
	195EX02	E2313	Harnessing for Expandable Controller \$473.00

R-net Joystick			
<input type="checkbox"/>	195J70	-	Std LED Joystick for R-net Ctrls N/C
<input type="checkbox"/>	195J108	-	CJSM1: Joystick Standard: w/Stereo Jacks & Color Display N/C
<input type="checkbox"/>	195J114	-	CJSM2: Joystick Advanced: 3.5" Color Display, Paddle Switches, Shortcut Keys, IR, BT, and Stereo Jack. \$1,132.00
<input type="checkbox"/>	195J95	-	Omit JS. For use with Omni2 N/C

Joystick Mount (Fixed, Swing Away, Retractable, Mid)			
<input type="checkbox"/>	195JM10	-	Fixed Mount N/C
<input type="checkbox"/>	195JM11	E1028	Swing Away Mount \$263.00
<input type="checkbox"/>	195JM15	E1028	Retractable Joystick mount w/45° stops \$628.00
<input type="checkbox"/>	195JM14	E1028	Mid Line Mount \$263.00

Joystick Mount (Location)			
<i>Height Adjustable.</i>			
<input type="checkbox"/>	195HM1	-	Right Side Mount N/C
<input type="checkbox"/>	195HM2	-	Left Side Mount N/C

Joystick Handle (Optional)			
<input type="checkbox"/>	195JH1	E2323	Ball Handle \$86.00
<input type="checkbox"/>	195JH2	E2323	Foam Ball Handle \$86.00
<input type="checkbox"/>	195JH4	E2323	T-Handle \$86.00
<input type="checkbox"/>	195JH6	E2323	Goalpost \$86.00

Attendant Control			
<input type="checkbox"/>	1950A01	E2331	Attendant Control for VR-2 \$1,101.00
<input type="checkbox"/>	1950A02	E2331	Attendant Control for R-net \$1,101.00

Attendant Mounting Location			
<input type="checkbox"/>	195DN1		Mounting location: Right Back Cane N/C
<input type="checkbox"/>	195DN2		Mounting Location: Left Back Cane N/C

R-net Omni2 and Output Options			
<i>(For expandable controls, choose all that apply)</i>			
<input type="checkbox"/>	195ON16	-	R-net Omni2 Input Control Module and 3.5" LCD display with built in Infrared, Bluetooth and armrest mount. Choose mount below. (required for Specialty Input Devices.) \$1,132.00
<input type="checkbox"/>	195ON2	E2351	R-net Output Module (ECM) \$1,101.00

Omni2 Mount			
<i>(If used with Joystick must be mounted opposite side)</i>			
<input type="checkbox"/>	195DS17	E1028	Swing Away Left Side Omni2 Mount w/ Rear Mounted Interface \$263.00
<input type="checkbox"/>	195DS16	E1028	Swing Away Right Side Omni2 Mount w/ Rear Mounted Interface \$263.00

Switch inputs for R-Net Joysticks or Omni2			
<i>Drive or Mode / Profile Control</i>			
<input type="checkbox"/>	195SW22		Stereo to 2 Mono Splitter \$69.00
<input type="checkbox"/>	195SW1		Buddy Button Switch \$86.00
<input type="checkbox"/>	195SW4		Micro Light Switch \$86.00
<input type="checkbox"/>	195SW24		Egg Switch-Black \$107.00
<input type="checkbox"/>	195SW21		Dual toggle switch and bracket \$403.00
<input type="checkbox"/>	195SW35		Switch-It Mini 1 button on Mono plug \$215.00
<input type="checkbox"/>	195SW36		Switch-It Mini 2 button on 2 Mono plugs \$215.00
<input type="checkbox"/>	195SW37		Switch-It Mini 2 button on 1 Stereo plug \$215.00
<input type="checkbox"/>	195SW38		Switch-It Mini 4 button on DB9 connector \$215.00

Single Switch Mount Bracket			
<input type="checkbox"/>	195EM01		Single Switch Mount Bracket \$215.00

Electronic Programmers			
<input type="checkbox"/>	195PR2		VR-2 Hand Held Programmer \$279.00
<input type="checkbox"/>	195PR5		R-net PC Programmer with Dongle \$445.00

5. Specialty Driver Control Options

Requires expandable R-net controls and Omni2 unless otherwise noted. Not available with Upholstered backs.

5a. Proportional Control Packages

Head Control Proportional Packages			
□ Switch-It Dual Pro Proportional Head Control with Whitmyer and Facial Pads (Adult)			\$5,942.00
195ID72	E2328	Switch-It Dual Pro Head Control w/facial pad (Adult)	\$5,577.00
195IJ09	E1028	SA Boom Mount with Egg Switch Control	\$365.00
□ Switch-It Dual Pro Proportional Head Control with Spot Pads Package			\$5,942.00
195ID70	E2328	Switch-It Dual Pro Head Control w/Spot pads	\$5,577.00
195IJ09	E1028	SA Boom Mount with Egg Switch Control	\$365.00

Hand Control Proportional Joystick Packages			
□ Switch-It Versa-Guide Compact Joystick Midline with Gatlin Package			\$2,034.00
195ID71	E2373	Switch-It Versa-Guide Compact Proportional Joystick	\$1,771.00
195IJ07	E1028	S/A Gatlin Mount	\$263.00
□ Switch-It Versa-Guide Compact Joystick Midline and prox flex switches with Gatlin Package			\$2,599.00
195ID71	E2373	Switch-It Versa-Guide Compact Proportional Joystick	\$1,771.00
195IM08	K0108	Dual Flex Proximity Switches (requires no force)	\$564.00
195IJ07	E1028	S/A Gatlin Mount	\$263.00
□ Switch-It Micro-Pilot Joystick with SpaceDisc Package			\$3,875.00
195ID62	E2312	Micro-Pilot Proportional Joystick	\$3,215.00
195IJ08	K0108	S/A SpaceDisc mount	\$660.00
□ Switch-It Micro-Guide Joystick with SpaceDisc Package			\$3,875.00
195ID63	E2312	Micro-Guide Proportional Joystick	\$3,215.00
195IJ08	K0108	S/A SpaceDisc mount	\$660.00

Chin Control Proportional Joystick Packages			
□ Switch-It Versa-Guide Chin Control Compact Joystick and Egg Switch Package			\$2,411.00
195ID71	E2373	Switch-It Versa-Guide Compact Proportional Joystick	\$1,771.00
195IM07	E1028	S/A Mount off backrest	\$275.00
195IJ04	E1028	SA Boom Mount with egg switch	\$365.00
□ Switch-It Versa-Guide Chin Control Compact Joystick and Proximity Flex Switches Package			\$2,610.00
195ID71	E2373	Switch-It Versa-Guide Compact Proportional Joystick	\$1,771.00
195IM08	K0108	Dual Flex Proximity Switches (requires no force)	\$564.00
195IM07	E1028	S/A Mount off backrest	\$275.00
□ Switch-It Versa-Guide Bib Chin Control Compact Joystick with Proximity Flex switches Package Std 6"			\$2,995.00
195ID71	E2373	Switch-It Versa-Guide Compact Proportional Joystick	\$1,771.00
195IM08	K0108	Dual Flex Proximity Switches (requires no force)	\$564.00
195IM05	K0108	Bib mount Small	\$660.00
□ Switch-It Versa-Guide Bib Chin Control Compact Joystick with Proximity Flex Switches Package Large 8"			\$2,995.00
195ID71	E2373	Switch-It Versa-Guide Compact Proportional Joystick	\$1,771.00
195IM08	K0108	Dual Flex Proximity Switches (requires no force)	\$564.00
195IM06	K0108	Bib mount Large	\$660.00
□ Switch-It Versa-Guide Bib Chin Control Compact Joystick with Egg Switch Package Std 6"			\$2,796.00
195ID71	E2373	Switch-It Versa-Guide Compact Proportional Joystick	\$1,771.00
195IM05	K0108	Bib mount Small	\$660.00
195IJ04	E1028	SA Boom Mount with egg switch	\$365.00
□ Switch-It Versa-Guide Bib Chin Control Compact Joystick with Egg Switch Package Large 8"			\$2,796.00
195ID71	E2373	Switch-It Versa-Guide Compact Proportional Joystick	\$1,771.00
195IM06	K0108	Bib mount Large	\$660.00
195IJ04	E1028	SA Boom Mount with egg switch	\$365.00
□ Switch-It Micro-Pilot Bib Chin Control with Egg Switch Package Std 6"			\$4,241.00
195ID62	E2312	Micro-Pilot Proportional Joystick	\$3,215.00
195IM05	K0108	Bib mount Small	\$660.00
195IJ04	E1028	SA Boom Mount with egg switch	\$365.00
□ Switch-It Micro-Pilot Bib Chin Control with Egg Switch Package Large 8"			\$4,241.00
195ID62	E2312	Micro-Pilot Proportional Joystick	\$3,215.00
195IM06	K0108	Bib mount Large	\$660.00
195IJ04	E1028	SA Boom Mount with egg switch	\$365.00
□ Switch-It Micro-Guide Bib Chin Control with Egg Switch Package Std 6"			\$4,241.00
195ID63	E2312	Micro-Guide Proportional Joystick	\$3,215.00
195IM05	K0108	Bib mount Small	\$660.00
195IJ04	E1028	SA Boom Mount with egg switch	\$365.00
□ Switch-It Micro-Guide Bib Chin Control with Egg Switch Package Large 8"			\$4,241.00
195ID63	E2312	Micro-Guide Proportional Joystick	\$3,215.00
195IM06	K0108	Bib mount Large	\$660.00
195IJ04	E1028	SA Boom Mount with egg switch	\$365.00

5. Specialty Driver Control Options (cont.)

5b. Switch Control

Requires Headrest and/or Headrest Mount

3 Switch Proximity Head Arrays Choose headrest mount below

<input type="checkbox"/> Switch-It Head Array Package 3 Switch Curved (Long)			\$4,869.00
195II13	E2330	Switch-It Proximity Head Array Long	\$4,504.00
195IJ09	E1028	SA Boom Mount with Egg Switch Control	\$365.00
<input type="checkbox"/> Switch-It Head Array Package 3 switch curved (Stubby)			\$4,869.00
195II14	E2330	Switch-It Proximity Head Array Stubby	\$4,504.00
195IJ09	E1028	SA Boom Mount with Egg Switch Control	\$365.00

Sip N Puff Package Choose headrest and HR mount below

<input type="checkbox"/> Quickie Sip n' Puff System			\$2,341.00
195ID34	E2325	Sip N' Puff Kit	\$1,572.00
195IH1	E2326	Sip n' Puff Tubing and SA Hardware	\$403.00
195IJ10	E1028	S/A Boom Mount with egg switch	\$365.00

Whitmyer Headrest Mount for Specialty Controls

<input type="checkbox"/>	195MH12	E1028	Axys Mount & Bracket for Specialty Controls	\$247.00
<input type="checkbox"/>	195MH13	E1028	Cobra Mount & Bracket for Specialty Controls	\$312.00
<input type="checkbox"/>	195MH14	E1028	Linx Mount & Bracket for Specialty Controls	\$247.00

Whitmyer Headrest Pad for Specialty controls

<input type="checkbox"/>	195HE79	E0955	Plush Pad 8" for Specialty controls	\$247.00
<input type="checkbox"/>	195HE80	E0955	Plush Pad 10" for Specialty controls	\$247.00
<input type="checkbox"/>	195HE81	E0955	Plush Pad 14" for Specialty controls	\$247.00

5 Switch Proximity Head Array (No Egg Switch Needed) Choose "Headrest Mount for Special Controls"

<input type="checkbox"/>	195II04	E2330	Switch-It Head Array 5 switch flat	\$4,611.00
--------------------------	---------	-------	------------------------------------	------------

Multiple Switches.

<input type="checkbox"/>	195SW31		Switch-It 3 Naked proximity switches on DB9 connector. (requires Omni2)	\$2,872.00
<input type="checkbox"/>	195SW32		Switch-It 4 Naked proximity switches on DB9 connector. (requires Omni2)	\$3,532.00
<input type="checkbox"/>	195SW33		Switch-It 5 Naked proximity switches on DB9 connector. (requires Omni2)	\$3,977.00
<input type="checkbox"/>	195SW23		4-way toggle switch button DB9 Connector. Includes bracket	\$590.00

Extra Swing Away Head Boom Egg Switch and Mount

195IJ05	E1028	Extra S/A Boom Mount with egg switch #1	\$365.00
195IJ06	E1029	Extra S/A Boom Mount with egg switch #2	\$365.00

Single Switches

<input type="checkbox"/>	195IB01		Ribbon Switch	\$107.00
<input type="checkbox"/>	195IB02		Buddy Button Switch	\$86.00
<input type="checkbox"/>	195IB03		Disc Switch	\$177.00
<input type="checkbox"/>	195IB04		Wobble Switch	\$553.00
<input type="checkbox"/>	195IB05		Micro Light Switch	\$86.00
<input type="checkbox"/>	195IB06		Egg Switch-Black	\$107.00
<input type="checkbox"/>	195IB07		Switch-It Mini 1 button on Mono plug	\$215.00

6. SEAT TYPE

<input type="checkbox"/>	195ST56	-	Quickie A.S.A.P II (Adjustable Seating and Positioning) Choose Seat Frame Size Platform.	N/C
--------------------------	---------	---	--	-----

ASAP II Frame size

(each frame is width and depth adjustable within given range.)

<input type="checkbox"/>	195FU17	-	Adjustable 12x12 to 16X19 (A)	N/C
<input type="checkbox"/>	195FU18	-	Adjustable 16x12 to 20x20 (B)	N/C
<input type="checkbox"/>	195FU19	-	Adjustable 18x16 to 22x22 (C)	N/C

7. SEAT SIZE

Seat Size Matrix. Seat type is chosen in section 5.

A = ASAP II Seat Frame Adjustable from 12x12 to 16X19
 B = ASAP II Seat Frame Adjustable from 16X12 to 20X20
 C = ASAP II Seat Frame Adjustable from 18X16 to 22X22

		ASAP II Seat Width (Adjustable)									
		12"	13"	14"	15"	16"	17"	18"	19"	20"	22"
Seat Depth (Adjustable)	12"	A	A	A	A	A,B	B	B	B	B	
	13"	A	A	A	A	A,B	B	B	B	B	
	14"	A	A	A	A	A,B	B	B	B	B	
	15"	A	A	A	A	A,B	B	B	B	B	
	16"	A	A	A	A	A,B	B	B,C	B,C	B,C	C
	17"	A	A	A	A	A,B	B	B,C	B,C	B,C	C
	18"	A	A	A	A	A,B	B	B,C	B,C	B,C	C
	19"	A	A	A	A	A,B	B	B,C	B,C	B,C	C
	20"					B	B	B,C	B,C	B,C	C
	21"							C	C	C	C
22"							C	C	C	C	

Seat Width

<input type="checkbox"/>	195R21	12"	Seat width	N/C
<input type="checkbox"/>	195R22	13"	Seat width	N/C
<input type="checkbox"/>	195R23	14"	Seat width	N/C
<input type="checkbox"/>	195R24	15"	Seat width	N/C
<input type="checkbox"/>	195R5	16"	Seat width	N/C
<input type="checkbox"/>	195R6	17"	Seat width	N/C
<input type="checkbox"/>	195R7	18"	Seat width	N/C
<input type="checkbox"/>	195R8	19"	Seat width	N/C
<input type="checkbox"/>	195R9	20"	Seat width	N/C
<input type="checkbox"/>	195R25	22"	Seat width	N/C

Seat Depth

<input type="checkbox"/>	195RF20	12"	Seat depth	N/C
<input type="checkbox"/>	195RF21	13"	Seat depth	N/C
<input type="checkbox"/>	195RF22	14"	Seat depth	N/C
<input type="checkbox"/>	195RF23	15"	Seat depth	N/C
<input type="checkbox"/>	195RF5	16"	Seat depth	N/C
<input type="checkbox"/>	195RF6	17"	Seat depth	N/C
<input type="checkbox"/>	195RF7	18"	Seat depth	N/C
<input type="checkbox"/>	195RF8	19"	Seat depth	N/C
<input type="checkbox"/>	195RF24	20"	Seat depth	N/C
<input type="checkbox"/>	195RF25	21"	Seat depth	N/C
<input type="checkbox"/>	195RF26	22"	Seat depth	N/C

8. SEAT CUSHIONS

JAY Cushion Bundling

<input type="checkbox"/>	195JC14	-	Jay Cushion <u>On Chair Order</u> Choose Cushion in section 17c.	NC
--------------------------	---------	---	---	----

9. POWERED SEATING

Power Seating Options

<input type="checkbox"/>	195PJ2	E1002	Quickie SPOT 50° CG Tilt (1 Actuator)	\$5,314.00
--------------------------	--------	-------	---------------------------------------	------------

Power Seating Control

Powered Seating Switch Control Method

(For use with power seating actuators. Switch activation is stand-alone and does not require expandable or thru-drive electronics.)

Single Actuator Switch Control (Tilt)

<input type="checkbox"/>	195EO10	-	Switch Control 1 actuator with <u>Dual Toggle</u>	N/C
<input type="checkbox"/>	195EO11	-	Switch Control 1 actuator with <u>Buddy Button</u>	N/C
<input type="checkbox"/>	195EO19	-	Switch Control 1 actuator with Switch-It Mini 1 button	N/C
<input type="checkbox"/>	195EO20	-	Switch Control 1 actuator with Switch-It Mini 2 button	N/C

2-3 Actuator Switch Control (Tilt/Legs or Legs only)

<input type="checkbox"/>	195EO21	-	Switch Control 2-3 actuator with <u>Dual Toggle</u>	\$537.00
<input type="checkbox"/>	195EO12	-	Switch Control 2-3 actuator with <u>4-way toggle</u>	\$805.00
<input type="checkbox"/>	195EO23	-	Switch Control 2-3 actuator with Switch-It Mini 2 button	\$537.00
<input type="checkbox"/>	195EO22	-	Switch Control 2-3 actuator with Switch-It Mini 4 button	\$537.00

Switch Mount

(for use with switch control powered seating)

<input type="checkbox"/>	195EY01	-	Switch Mount Right	N/C
<input type="checkbox"/>	195EY02	-	Switch Mount Left	N/C

Powered Seating Thru-drive Control Method.

Thru-Drive 1 Actuator

<input type="checkbox"/>	195EO28	E2310	Thru Drive 1 Actuator (For operating Tilt thru Joystick.) Includes Ctrl+5 when ordered with R-net.	\$2,169.00
--------------------------	---------	-------	--	------------

Thru-Drive 2+ Actuator (Requires R-net)

<input type="checkbox"/>	195EO29	E2311	Thru Drive 2+ Actuators: (For operating Tilt, power legs) Includes Ctrl+5	\$3,853.00
--------------------------	---------	-------	---	------------

Powered Seating Thru-drive Control Options

Assignable Buttons (Requires R-net)

"Assignable Button" feature allows for personalization of joystick buttons and/or Ctrl+5 Switches allowing access to various wheelchair and seating functions. When enabled, chair will be pre-programmed with seating functions assigned to buttons on the joystick. Assignments can be changed via PC Dongle.

<input type="checkbox"/>	195PM01	-	Enable Assignable buttons	N/C
--------------------------	---------	---	---------------------------	-----

Ctrl+5 Switchbox Options (Requires R-net)

Ctrl+5 allows direct control to 5 power seating functions (10 total switches).

Switches can also be used with assignable buttons for greater flexibility.

Box includes 3-Amp USB port for charging portable devices

<input type="checkbox"/>	195QG01	-	Ctrl+5 Switchbox mounted behind joystick	N/C
<input type="checkbox"/>	195QG02	-	Ctrl+5 Switchbox mounted opposite joystick	N/C
<input type="checkbox"/>	195QG03	-	Ctrl+5 Switchbox mounted on back cane	N/C
<input type="checkbox"/>	195QG05	-	Omit Ctrl+5	-\$500.00



Ctrl+5 Switch Type

<input type="checkbox"/>	195EY03	-	Push buttons	N/C
<input type="checkbox"/>	195EY04	-	Toggle switches	\$268.00

10. BACKREST AND BACK OPTIONS FOR ASAP II SEAT

Backrest Frame Type

<input type="checkbox"/>	195BT8	-	Angle Adjustable	N/C
<input type="checkbox"/>	195BT98	E1225	Manual Recline 40° (not width adjust.)	\$473.00

Manual Recline Adjustment Method Option

Back Height 23". NA with Cantilever Arms

<input type="checkbox"/>	195MN01		Tool	N/C
<input type="checkbox"/>	195MN02		Knob (NA with dual post arms.)	N/C

Angle Adjustable Backrest Options

(NA with Manual recline)

<input type="checkbox"/>	195OD8		Non-Folding Backrest	N/C
<input type="checkbox"/>	195OD9		Folding Backrest (Max weight 250lbs)	\$123.00

Back Cane Angle

<input type="checkbox"/>	195BP40		Straight Back Post	N/C
<input type="checkbox"/>	195BP41		8° Bend Back Post (Avail. only J3 Back) NA with Manual recline	\$113.00

Back Cane height

<input type="checkbox"/>	195B1		Fixed Low (15.5")	N/C
<input type="checkbox"/>	195B5		Fixed Med (17.5")	N/C
<input type="checkbox"/>	195B9		Fixed Tall (19.5")	N/C
<input type="checkbox"/>	195B243		Adjustable Low 14" - 18"	\$113.00
<input type="checkbox"/>	195B244		Adjustable High 20" - 26"	\$113.00

Towel Bar Depth

<input type="checkbox"/>	195QT03		Shallow (NA with Upholstery backs.)	N/C
<input type="checkbox"/>	195QT04		Deep (Ext. 4" from back canes for deep backs)	N/C

Back Type (Upholstery or Solid)

<input type="checkbox"/>	195BU76	-	S.P.O.T. Curved	N/C
<input type="checkbox"/>	195BU77	E2613	JAY SPO Posterior	\$526.00
<input type="checkbox"/>	195BU14	-	Omit Upholstery	-\$15.00

JAY J3 Option (select Omit above)

<input type="checkbox"/>	195JB08	-	JAY J3 <u>On Chair Order</u> Choose back, headrest, laterals in section 17a,b,c	NC
--------------------------	---------	---	--	----

Back Height - Required for SPOT Curved and SPO Backs.

(Limited combinations of widths) Measured from pan to top of solid back.

<input type="checkbox"/>	195B132	-	14"	N/C
<input type="checkbox"/>	195B36	-	16"	N/C
<input type="checkbox"/>	195B38	-	18"	N/C
<input type="checkbox"/>	195B40	-	20"	N/C
<input type="checkbox"/>	195B42	-	22"	N/C
<input type="checkbox"/>	195B44	-	24"	N/C
<input type="checkbox"/>	195B140	-	26"	N/C

12. HEADREST OPTIONS

For use with SPOT, and JAY SPO Backrest Only. Choose One Each.

Whitmyer Headrest Mount			
<input type="checkbox"/>	195MH10	E1028	Axys Mount & Bracket \$247.00
<input type="checkbox"/>	195MH11	E1028	Cobra Mount and Bracket \$312.00
<input type="checkbox"/>	195MH1	E1028	Linx Mount and Bracket \$247.00

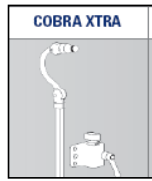
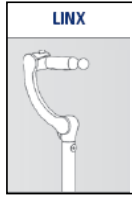
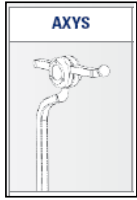

Whitmyer Headrest Pad			
<input type="checkbox"/>	195HE65	E0955	Plush Head Support Pad 8" \$247.00
<input type="checkbox"/>	195HE66	E0955	Plush Head Support Pad 10" \$247.00
<input type="checkbox"/>	195HE78	E0955	Plush Head Support Pad 14" \$247.00
<input type="checkbox"/>	195HE82	E0955	Adjusta Plush Head Support Pad Narrow \$247.00
<input type="checkbox"/>	195HE83	E0955	Adjusta Plush Head Support Pad std \$247.00

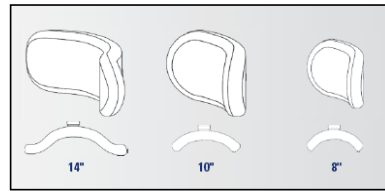

13. POSTURAL SUPPORTS

LATERAL THORACIC SUPPORT (Swing Away)			
<i>Available on SPOT and JAY SPO Solid Backs.</i>			
<input type="checkbox"/>	LAT 4X4 S/A MOUNTS W/ 1" OFFSET - PR		\$864.00
	195ZV14	E0956	LATERAL 4X4 W/ 1" OFFSET - PAIR \$279.00
	195ZS07	E1028	LATERAL SWING AWAY MOUNT - PAIR \$585.00
<input type="checkbox"/>	LAT 4X5 S/A MOUNTS W/ 1" OFFSET - PR		\$864.00
	195ZV15	E0956	LATERAL 4X5 W/ 1" OFFSET - PAIR \$279.00
	195ZS07	E1028	LATERAL SWING AWAY MOUNT - PAIR \$585.00
<input type="checkbox"/>	LAT 4X6 S/A MOUNTS W/ 1" OFFSET - PR		\$864.00
	195ZV16	E0956	LATERAL 4X6 W/ 1" OFFSET - PAIR \$279.00
	195ZS07	E1028	LATERAL SWING AWAY MOUNT - PAIR \$585.00
<input type="checkbox"/>	LAT 6X4 S/A MOUNTS W/ 1" OFFSET - PR		\$864.00
	195ZV17	E0956	LATERAL 6X4 W/ 1" OFFSET - PAIR \$279.00
	195ZS07	E1028	LATERAL SWING AWAY MOUNT - PAIR \$585.00
<input type="checkbox"/>	LAT 6X5 S/A MOUNTS W/ 1" OFFSET - PR		\$864.00
	195ZV18	E0956	LATERAL 6X5 W/ 1" OFFSET - PAIR \$279.00
	195ZS07	E1028	LATERAL SWING AWAY MOUNT - PAIR \$585.00
<input type="checkbox"/>	LAT 6X6 S/A MOUNTS W/ 1" OFFSET - PR		\$864.00
	195ZV19	E0956	LATERAL 6X6 W/ 1" OFFSET - PAIR \$279.00
	195ZS07	E1028	LATERAL SWING AWAY MOUNT - PAIR \$585.00

CHEST STRAP			
<input type="checkbox"/>	195ZR03	E0960	Padded Chest Strap \$247.00

Swing Away Knee Adductor Supports			
<i>Available only with Fixed and Power Center Mount Legrests.</i>			
<i>Not available with Dual Post Arm Rests or 2-point Locking Cantilever Arms</i>			
Knee Adductor Supports - LEFT (choose Pad and Arm)			\$436.00
Pad Size			
<input type="checkbox"/>	195KB5	E0956	Knee Adductor Pad SM- Left \$188.00
<input type="checkbox"/>	195KB7	E0956	Knee Adductor Pad LG- Left \$188.00
S/A Arm Size			
<input type="checkbox"/>	195XX04	E1028	Swing Away Short - Left \$247.00
<input type="checkbox"/>	195XX06	E1028	Swing Away Long - Left \$247.00
Knee Adductor Supports - RIGHT (choose Pad and Arm)			\$436.00
Pad Size			
<input type="checkbox"/>	195KB6	E0956	Knee Adductor Pad SM- Right \$188.00
<input type="checkbox"/>	195KB8	E0956	Knee Adductor Pad LG- Right \$188.00
S/A Arm Size			
<input type="checkbox"/>	195XX05	E1028	Swing Away Short - Right \$247.00
<input type="checkbox"/>	195XX07	E1028	Swing Away Long - Right \$247.00
Long Thigh Support w/Removable Mount			
<i>Available with Cantilever Arms, NA with Manual Recline Back, Dual Post, Single Post or Cantilever w/ 2 pt Locking arms.</i>			
<input type="checkbox"/>	SPOT Long Thigh Support - Left		\$360.00
	195TV2	E0956	Long Thigh Support - Left \$113.00
	195TX1	E1028	Removable Mount - Left \$247.00
<input type="checkbox"/>	SPOT Long Thigh Support - Right		\$360.00
	195TV1	E0956	Long Thigh Support - Right \$113.00
	195TX2	E1028	Removable Mount - Right \$247.00

14. ARMREST AND ARMPAD OPTIONS

Cantilever Armrest Mounting			
Cantilever Armrests			
<i>(Adjustable length arm pad included (choose Pad setting below, except for Low Arm Option) NA with Manual Recline Back</i>			
<input type="checkbox"/>	195EG12	-	STD Cantilever Arm 9"-12" Ht Range Std
<input type="checkbox"/>	195EG13	-	Low Cantilever Arm 7"-10" Ht Range (Choose ASAPII pad type and size below) NC
<input type="checkbox"/>	195EG10	-	Standard Cantilever Arm w/ 2 Point Locking Post. (9"-10" Ht Range.) NA w/ seat depths below 16" \$258.00
<input type="checkbox"/>	195EG11	-	Standard Cantilever Arm w/ 2 Point Locking Post. (11"-12" Ht Range.) NA w/ seat depths below 16" \$258.00

Cantilever Armpad			
Pad Setting Options for Standard Cantilever Arm			
Left Arm Pad (Std)		Right Arm Pad (Std)	
<input type="checkbox"/>	195AE11	-	Full Length Cantilever (14") <input type="checkbox"/> 195AB11
<input type="checkbox"/>	195AE10	-	Desk Length Cantilever (10") <input type="checkbox"/> 195AB10

Single - Dual Post Armrest Mounting			
Single Post Armrests			
<input type="checkbox"/>	195EG14	-	Single Post Height Adjustable - Std. \$258.00
<input type="checkbox"/>	195EG15	-	Single Post Height Adjustable - Low \$258.00

Dual Post Armrests			
<input type="checkbox"/>	195EG09	-	Shrt Dual Post Flip Back HT Adj 10"-15" \$258.00
<input type="checkbox"/>	195EG23	-	Lng Dual Post Flip Back HT Adj 10"-15" \$258.00

Pad Type / Size Options for Dual Post / Single Post / Low Cantilever			
Left Arm Pad (N/C)		Right Arm Pad (N/C)	
<input type="checkbox"/>	195AE01	-	Desk Length Waterfall (10") <input type="checkbox"/> 195AB01
<input type="checkbox"/>	195AE02	-	Full Length Waterfall (14") <input type="checkbox"/> 195AB02
			<i>NA w/Low Cantilever arm</i>
<input type="checkbox"/>	195AE03	-	Desk Length Standard (10") <input type="checkbox"/> 195AB03
<input type="checkbox"/>	195AE04	-	Full Length Standard (14") <input type="checkbox"/> 195AB04
			<i>NA w/Low Cantilever arm</i>

15. HANGERS AND FOOTRESTS

Swing-away Hangers

Non-Powered Swing Away Legrests

Sold as Pairs

<input type="checkbox"/>	195H2		70° Swing Away (B)	N/C
<input type="checkbox"/>	195H6		90° Swing Away (B) (5.5-9")	N/C
<input type="checkbox"/>	195H138	E0990	Manual ELR S/A (B) (Avail. with Fixed Centermount, choose below)	\$301.00

Power Elevating Legrests (2 Actuators)

<input type="checkbox"/>	195H126	E1010	Swing Away Power ELR w/ Articulation Pair (B footplates) (N/A for 12" or 13" wide)	\$2,565.00
--------------------------	---------	-------	--	------------

Swing Away Footplates

<input type="checkbox"/>	B - Adult Angle Adjust w/Heel Loop for use with 70° hanger and ELR (Pair)			\$236.00
	195F282	K0040	Adult Angle Adjustable Footplate	\$182.00
	195HL10	E0951	Heel Loop	\$54.00
<input type="checkbox"/>	B - Adult Angle Adjust w/Heel Loop for use with 90° hanger (Pair)			\$236.00
	195F285	K0040	Adult Angle Adjustable Footplate	\$182.00
	195HL10	E0951	Heel Loop	\$54.00
<input type="checkbox"/>	C - Kids Angle Adjust w/Leg Strap for use with 70° hanger (Pair)			\$220.00
	195F283	K0040	Kids Angle Adjustable Footplate	\$182.00
	195LS13	K0038	Leg Strap	\$38.00
<input type="checkbox"/>	C - Kids Angle Adjust w/Leg Strap for use with 80° and 90° hanger(Pair)			\$220.00
	195F286	K0040	Kids Angle Adjustable Footplate	\$182.00
	195LS13	K0038	Leg Strap	\$38.00

Omit Hangers.

<input type="checkbox"/>	195H144		Omit Hangers	N/C
--------------------------	---------	--	--------------	-----

Hanger Extensions. (See range listed in matrix below)

NOTE: Not all extension tube will be available; depending on the seat height, some extension tube options may not offer enough ground clearance.

<input type="checkbox"/>	195E16	K0037	High Mount Hanger	\$59.00
<input type="checkbox"/>	195E1		Short	N/C
<input type="checkbox"/>	195E2		Medium	N/C
<input type="checkbox"/>	195E5		Long	N/C

Footrest Accessories

<input type="checkbox"/>	195A01	E0952	Toe Loop (Pair) Only avail on (opt B).	\$54.00
<input type="checkbox"/>	195LS14	K0038	Extra Leg Strap	\$38.00
<input type="checkbox"/>	195F279		Omit Footplate and extension tube	N/C

Lower Leg Length Matrix (measured seat pan to the top of the footplate surface)					Footplate Matrix			
Hanger Type	Standard	High Mount	Short	Medium	Long	B	F	I
70° Swing Away		7"-14"	13.5"-16"	16"-18.5"	18"-20.5"	X		
90° Swing Away		5.5-9" Footplate mounts to front of hanger.					X	
Manual ELR S/A			12.5"-17"	14.5"-19"	17"-21"	X		
Power ELR S/A			12"-14"	14"-17"	16.5"-19"	X		
Fixed Cntrmnt ASAP			12.5"-15.5"		14.5"-19.5"			Single Footplate
Angle Adj Cntrmnt				3"-13"	3"-15"			X
Power Cntrmnt	3"-19"							X

Centermount Legrests

Non-Powered Center Mount Legrests

Fixed Center Mount Legrests (includes footplate)

Plus options below

<input type="checkbox"/>	195H134	-	Fixed Center ASAP II Mount Short	N/C
<input type="checkbox"/>	195H135	-	Fixed Center ASAP II Mount Long	N/C

Angle Adjustable Center Mount Legrests for ASAP II

<input type="checkbox"/>	195H104	-	Angle adjustable Center Mount Medium 3" - 11.25" Choose Footplate (I or J) infinite and Independent leg length and angle adjustable	\$338.00
<input type="checkbox"/>	195H108	-	Angle adjustable Center Mount Long 3" - 13.25" Choose Footplate (I or J) infinite and Independent leg length and angle adjustable	\$338.00

Power Centermount (2 Actuators)

<input type="checkbox"/>	195H127	K0108	Power Centermount ELR w/7.5" Power Articulation (F) Centermount footplates w/ programming options below	\$2,621.00
--------------------------	---------	-------	---	------------

Power Centermount Footplate Extension Option (For Thru-Drive Operation)

<input type="checkbox"/>	195IE01	K0108	Enable 7.5" Powered footplate extension for transfer assist. (Electronics programmed to allow footplates to be extended with or without legrest being raised)	\$1,412.00
<input type="checkbox"/>	195IE02	-	Disable Footplate extension for transfers. (Electronics programmed to ONLY extend footplates when legs are raised.)	N/C

Centermount Footplates

<input type="checkbox"/>	F - Centermount Dual Footplate (Pair) (Individually Height (3"-19") and Angle Adjustable)			\$182.00
	195F315	K0040	CMT Angle Adjustable Footplates	\$182.00
	195HL14	E0951	Padded and Adjustable Heel Block	N/C
<input type="checkbox"/>	I - Angle adj Centermount Footplate pair Small			\$182.00
	195F125	K0040	Small Angle Adjustable Footplates 5.75" x 6"	\$182.00
<input type="checkbox"/>	J - Angle adj Centermount Footplate pair Large			\$182.00
	195F126	K0040	Large Angle Adjustable Footplates 5.75" x 10"	\$182.00

16. ACCESSORIES

Wheelchair Tray Table

<input type="checkbox"/>	1957A01	E0950	TRAY TABLE SM TUFFAK 12"-14" PWR	\$247.00
<input type="checkbox"/>	1957A02	E0950	TRAY TABLE MED TUFFAK 15"-17" PWR	\$247.00
<input type="checkbox"/>	1957A03	E0950	TRAY TABLE LRG TUFFAK 18"-20" PWR	\$247.00

Backpack

<input type="checkbox"/>	195A1		Black Utility	\$59.00
--------------------------	-------	--	---------------	---------

Accessories

<input type="checkbox"/>	1958A09		Ram Phone Mount on Round JS tube	\$54.00
<input type="checkbox"/>	1958A10		Ram Tablet Mount on Round JS tube	\$215.00
<input type="checkbox"/>	1958A11		Ram Cup holder	\$54.00
<input type="checkbox"/>	1958A12		Switch-It Remote Stop Switch	\$961.00

Positioning Belt

<input type="checkbox"/>	195EJ01		Auto Style Buckle	N/C
<input type="checkbox"/>	195EJ02	E0978	Belt 2" Aircraft Buckle	\$43.00
<input type="checkbox"/>	195EJ03	E0978	Belt 2" Aircraft Buckle Padded	\$75.00

Mounting Accessories

Only one accessory can be mounted at a time.

<input type="checkbox"/>	195A603	E2207	Cane/Crutch Holder	\$279.00
<input type="checkbox"/>	195A604	E2208	O2 holder	\$279.00
<input type="checkbox"/>	195A605	K0108	Walker holder	\$279.00



JAY[®] Signature Series Backrest and Accessories

Note: Not all sizes and configurations shown below, for full offering visit www.sunrisemedical.com

17a. JAY BACKREST

Seat width must be equal to or 2" less than selection in section 7.

JAY J3 Back PA (2.2" Contour Depth)

UT Shells- Heavy Duty TH 2 Point Hardware

<input type="checkbox"/>	195JT01	E2613	J3PAUTS16TH	16" Wide J3 Back w/ 16.5" Shell Height	\$656.00
<input type="checkbox"/>	195JT02	E2613	J3PAUTS18TH	18" Wide J3 Back w/ 16.5" Shell Height	\$656.00
<input type="checkbox"/>	195JT03	E2613	J3PAUTS20TH	20" Wide J3 Back w/ 16.5" Shell Height	\$656.00
<input type="checkbox"/>	195JT04	E2613	J3PAUTM16TH	16" Wide J3 Back w/ 18" Shell Height	\$656.00
<input type="checkbox"/>	195JT05	E2613	J3PAUTM18TH	18" Wide J3 Back w/ 18" Shell Height	\$656.00
<input type="checkbox"/>	195JT06	E2613	J3PAUTM20TH	20" Wide J3 Back w/ 18" Shell Height	\$656.00
<input type="checkbox"/>	195JT07	E2614	J3PAUTM22TH	22" Wide J3 Back w/ 18" Shell Height	\$899.00
<input type="checkbox"/>	195JT08	E2613	J3PAUTT16TH	16" Wide J3 Back w/ 19.5" Shell Height	\$656.00
<input type="checkbox"/>	195JT09	E2613	J3PAUTT18TH	18" Wide J3 Back w/ 19.5" Shell Height	\$656.00
<input type="checkbox"/>	195JT10	E2613	J3PAUTT20TH	20" Wide J3 Back w/ 19.5" Shell Height	\$656.00

SH Shells- TH 2 Point Hardware

<input type="checkbox"/>	195JT11	E2613	J3PASHS18TH	18" Wide J3 Back w/ 21" Shell Height	\$656.00
<input type="checkbox"/>	195JT12	E2613	J3PASHS20TH	20" Wide J3 Back w/ 21" Shell Height	\$656.00
<input type="checkbox"/>	195JT13	E2614	J3PASHS22TH	22" Wide J3 Back w/ 21" Shell Height	\$899.00

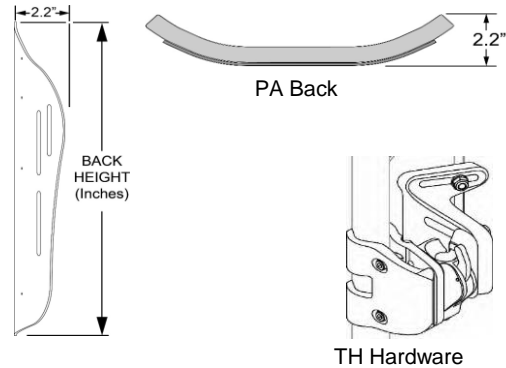

JAY J3 Back PD (6" Contour Depth)

UT Shells- Heavy Duty TH 2 Point Hardware

<input type="checkbox"/>	195JT14	E2620	J3PDUTM16TH	16" Wide J3 Back w/ 18" Shell Height	\$847.00
<input type="checkbox"/>	195JT15	E2620	J3PDUTM18TH	18" Wide J3 Back w/ 18" Shell Height	\$847.00
<input type="checkbox"/>	195JT16	E2620	J3PDUTM20TH	20" Wide J3 Back w/ 18" Shell Height	\$847.00

SH Shells- Heavy Duty TH 2 Point Hardware

<input type="checkbox"/>	195JT17	E2620	J3PDSHS16TH	16" Wide J3 Back w/ 21" Shell Height	\$847.00
<input type="checkbox"/>	195JT18	E2620	J3PDSHS18TH	18" Wide J3 Back w/ 21" Shell Height	\$847.00
<input type="checkbox"/>	195JT19	E2620	J3PDSHS20TH	20" Wide J3 Back w/ 21" Shell Height	\$847.00

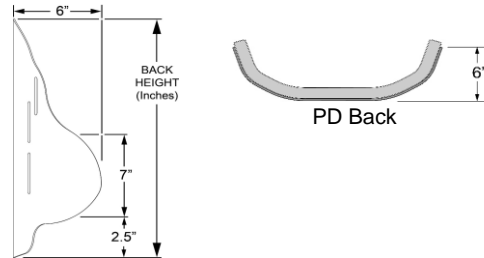

JAY J3 Back PL (3" Contour Depth)

UT Shells- Heavy Duty TH 2 Point Hardware

<input type="checkbox"/>	195JT20	E2613	J3PLUTS16TH	16" Wide J3 Back w/ 16.5" Shell Height	\$757.00
<input type="checkbox"/>	195JT21	E2613	J3PLUTS18TH	18" Wide J3 Back w/ 16.5" Shell Height	\$757.00
<input type="checkbox"/>	195JT22	E2613	J3PLUTS20TH	20" Wide J3 Back w/ 16.5" Shell Height	\$757.00
<input type="checkbox"/>	195JT23	E2613	J3PLUTM16TH	16" Wide J3 Back w/ 18" Shell Height	\$757.00
<input type="checkbox"/>	195JT24	E2613	J3PLUTM18TH	18" Wide J3 Back w/ 18" Shell Height	\$757.00
<input type="checkbox"/>	195JT25	E2613	J3PLUTM20TH	20" Wide J3 Back w/ 18" Shell Height	\$757.00
<input type="checkbox"/>	195JT26	E2613	J3PLUTT16TH	16" Wide J3 Back w/ 19.5" Shell Height	\$757.00
<input type="checkbox"/>	195JT27	E2613	J3PLUTT18TH	18" Wide J3 Back w/ 19.5" Shell Height	\$757.00
<input type="checkbox"/>	195JT28	E2613	J3PLUTT20TH	20" Wide J3 Back w/ 19.5" Shell Height	\$757.00

SH Shells- TH 2 Point Hardware

<input type="checkbox"/>	195JT29	E2613	J3PLSHS18TH	18" Wide J3 Back w/ 21" Shell Height	\$757.00
<input type="checkbox"/>	195JT30	E2613	J3PLSHS20TH	20" Wide J3 Back w/ 21" Shell Height	\$757.00

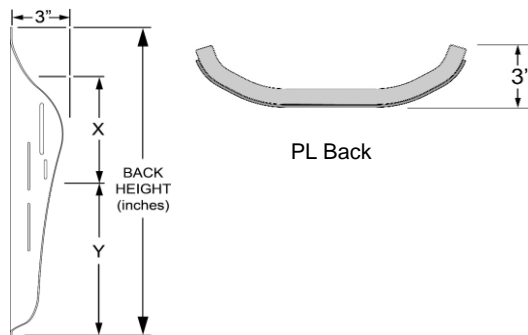

JAY Back

To order any **JAY Back not listed above**, please see the JAY price list. Cushion name or part number must be filled out w/ desired width and depth

<input type="checkbox"/>	195JB01	JAY Bundled Back	Back Name or Part #	Width:	Height:	Price List
--------------------------	---------	------------------	---------------------	--------	---------	------------

17b. JAY BACKREST ACCESSORIES

JAY J3 Back Headrest

AXYS Mount and Pad (includes removable mount)

<input type="checkbox"/>	195HD01	E0955/E1028	J3HEDX10	AXYS Headrest with 10" Plush Pad	\$430.00
<input type="checkbox"/>	195HD02	E0955/E1028	J3HEDX14	AXYS Headrest with 14" Plush Pad	\$445.00
<input type="checkbox"/>	195HD05	E0955/E1028	J3HEDXAAPS	AXYS Headrest with Narrow Adjust-a-Plush	\$543.00
<input type="checkbox"/>	195HD06	E0955/E1028	J3HEDXAAPN	AXYS Headrest with Standard Adjust-a-Plush	\$543.00

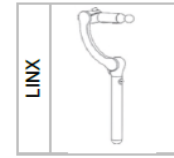
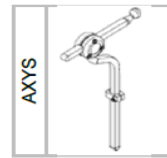

LINX Mount and Pad (includes removable mount)

<input type="checkbox"/>	195HD03	E0955/E1028	J3HEDL10	LINX Headrest with 10" Plush Pad	\$499.00
<input type="checkbox"/>	195HD04	E0955/E1028	J3HEDL14	LINX Headrest with 14" Plush Pad	\$618.00
<input type="checkbox"/>	195HD07	E0955/E1028	J3HEDLAAPS	LINX Headrest with Narrow Adjust-a-Plush	\$610.00
<input type="checkbox"/>	195HD08	E0955/E1028	J3HEDLAAPN	LINX Headrest with Standard Adjust-a-Plush	\$610.00

JAY J3 Back Laterals

Swing Away Laterals With Pad - Pair

<input type="checkbox"/>	195JW02	E0956/E1028	J3LAT4X4SA	SwingAway Lat with 4"x4" Pad (PR)	\$880.00
<input type="checkbox"/>	195JW03	E0956/E1028	J3LAT4X5SA	SwingAway Lat with 4"x5" Pad (PR)	\$880.00
<input type="checkbox"/>	195JW04	E0956/E1028	J3LAT4X6SA	SwingAway Lat with 4"x6" Pad (PR)	\$880.00

17c. JAY CUSHIONS

Seat width must match selection in section 7. Seat depth can be +/- 2" of selection in section 7

JAY Fusion Cushion

<input type="checkbox"/>	195JU01	E2622	JFUSION1616	JAY Fusion 16" x 16"	\$498.00
<input type="checkbox"/>	195JU02	E2622	JFUSION1618	JAY Fusion 16" x 18"	\$498.00
<input type="checkbox"/>	195JU03	E2622	JFUSION1816	JAY Fusion 18" x 16"	\$498.00
<input type="checkbox"/>	195JU04	E2622	JFUSION1818	JAY Fusion 18" x 18"	\$498.00
<input type="checkbox"/>	195JU05	E2622	JFUSION1820	JAY Fusion 18" x 20"	\$498.00
<input type="checkbox"/>	195JU06	E2622	JFUSION2018	JAY Fusion 20" x 18"	\$498.00
<input type="checkbox"/>	195JU07	E2622	JFUSION2020	JAY Fusion 20" x 20"	\$498.00

JAY X2 Cushion

<input type="checkbox"/>	195JU22	E2622	JX21616	JAY X2 16" x 16"	\$481.00
<input type="checkbox"/>	195JU23	E2622	JX21618	JAY X2 16" x 18"	\$481.00
<input type="checkbox"/>	195JU24	E2622	JX21816	JAY X2 18" x 16"	\$481.00
<input type="checkbox"/>	195JU25	E2622	JX21818	JAY X2 18" x 18"	\$481.00
<input type="checkbox"/>	195JU26	E2622	JX21820	JAY X2 18" x 20"	\$481.00
<input type="checkbox"/>	195JU27	E2622	JX22020	JAY X2 20" x 20"	\$481.00

JAY Union Cushion

<input type="checkbox"/>	195JU15	E2607	JU1616	JAY UNION 16" x 16"	\$503.00
<input type="checkbox"/>	195JU16	E2607	JU1618	JAY UNION 16" x 18"	\$503.00
<input type="checkbox"/>	195JU17	E2607	JU1816	JAY UNION 18" x 16"	\$503.00
<input type="checkbox"/>	195JU18	E2607	JU1818	JAY UNION 18" x 18"	\$503.00
<input type="checkbox"/>	195JU19	E2607	JU1820	JAY UNION 18" x 20"	\$503.00
<input type="checkbox"/>	195JU20	E2607	JU2018	JAY UNION 20" x 18"	\$503.00
<input type="checkbox"/>	195JU21	E2607	JU2020	JAY UNION 20" x 20"	\$503.00

JAY Ion Cushion

<input type="checkbox"/>	195JU08	E2607	JION1616	JAY ION 16" x 16"	\$446.00
<input type="checkbox"/>	195JU09	E2607	JION1618	JAY ION 16" x 18"	\$446.00
<input type="checkbox"/>	195JU10	E2607	JION1816	JAY ION 18" x 16"	\$446.00
<input type="checkbox"/>	195JU11	E2607	JION1818	JAY ION 18" x 18"	\$446.00
<input type="checkbox"/>	195JU12	E2607	JION1820	JAY ION 18" x 20"	\$446.00
<input type="checkbox"/>	195JU13	E2607	JION2018	JAY ION 20" x 18"	\$446.00
<input type="checkbox"/>	195JU14	E2607	JION2020	JAY ION 20" x 20"	\$446.00

JAY Cushion

*To order any **JAY cushions not listed above**, please see the JAY price list. Cushion name or part number must be filled out w/ desired width and depth*

<input type="checkbox"/>	195JC20	JAY Bundled Cushion	Cushion Name or Part #	Width:	Depth:	Price List
--------------------------	---------	---------------------	------------------------	--------	--------	------------

18. Personalized Options



Looking for more options? Contact our "Built-4-Me" department.

Below are common upgrades that utilize **Ready Made Quotes**. These options can be quickly quoted to add a personal touch to your Pulse power chair.

<input type="checkbox"/>	Lights and Indicators	Call for quote
<input type="checkbox"/>	Gel Flat 2" arm pads	Call for quote
<input type="checkbox"/>	Gel Flat 4" arm pads	Call for quote
<input type="checkbox"/>	Gel Trough/Elbow Block Medium (3.4" x 13") arm pads	Call for quote
<input type="checkbox"/>	Gel Trough/Elbow Block Large (4" x 14.5") arm pads	Call for quote

Some Restrictions Apply

To Inquire about any unique personalizing of Quickie products, contact:
Phone: (800) 333-4000, Option #3 or Fax: (800) 333-9011



Sunrise Medical (US) LLC
2842 Business Park Ave.
Fresno, CA 93727 · USA