

Mark For:

Date: _____
 Dealer Acct #: _____
 Dealer: _____
 Dealer Contact: _____
 Dealer Address: _____
 Dealer City: _____ ST: _____ ZIP: _____
 Dealer Phone: () _____ Fax: () _____
 Confirmation Email: _____
 Confirm Via: Fax Email

Submitting for:
 Quote Order

PO#: _____

ADDITIONAL SHIPPING INFORMATION





Ship To: _____
 Attention: _____
 Address: _____
 Address: _____
 Ship To City: _____ ST: _____ ZIP: _____
 Ship To Phone: () _____ Fax: () _____

The **HCPCS CODES** herein are based on PDAC verification or interpretation of Medicare definitions and guidelines. Non-Medicare payers may accept alternative **HCPCS CODES**, including misc. codes to ensure access for their enrollees. The use of **HCPCS CODES** does not ensure coverage or payment.

Head Positioning - Use HCPCS Code E0955

Whitmyer headrests come unassembled. Please add item WHITASSY001 if the dealer would like parts assembled. This is a no charge option.

Note: For cover selection, L = Lycra and V = Dartex Reversed (Example: AXYS-HUFALL or AXYS-HUFALV)

	<input type="checkbox"/> Receiver must be selected on pg 2		<input type="checkbox"/> Receiver must be selected on pg 2		<input type="checkbox"/> Receiver must be selected on pg 2		<input type="checkbox"/> Receiver must be selected on pg 2
PAD	AXYS	ONYX	LINX	LINX²			



CONTOUR CRADLE	Large	<input type="checkbox"/> AXYS-CCS4L \$215	<input type="checkbox"/> ONYX-CCS4L \$215	<input type="checkbox"/> LINX-CCS4L \$166	<input type="checkbox"/> LINX2-CCS4L \$204
	Medium	<input type="checkbox"/> AXYS-CCS4V \$215	<input type="checkbox"/> ONYX-CCS4V \$215	<input type="checkbox"/> LINX-CCS4V \$166	<input type="checkbox"/> LINX2-CCS4V \$204
	Small	<input type="checkbox"/> AXYS-CCS3L \$204	<input type="checkbox"/> ONYX-CCS3L \$204	<input type="checkbox"/> LINX-CCS3L \$156	<input type="checkbox"/> LINX2-CCS3L \$194
		<input type="checkbox"/> AXYS-CCS3V \$204	<input type="checkbox"/> ONYX-CCS3V \$204	<input type="checkbox"/> LINX-CCS3V \$156	<input type="checkbox"/> LINX2-CCS3V \$194
		<input type="checkbox"/> AXYS-CCS2L \$194	<input type="checkbox"/> ONYX-CCS2L \$194	<input type="checkbox"/> LINX-CCS2L \$145	<input type="checkbox"/> LINX2-CCS2L \$182

C-PLUSH	Large	<input type="checkbox"/> AXYS-CCP4L \$215	<input type="checkbox"/> ONYX-CCP4L \$215	<input type="checkbox"/> LINX-CCP4L \$166	<input type="checkbox"/> LINX2-CCP4L \$204
	Medium	<input type="checkbox"/> AXYS-CCP4V \$215	<input type="checkbox"/> ONYX-CCP4V \$215	<input type="checkbox"/> LINX-CCP4V \$166	<input type="checkbox"/> LINX2-CCP4V \$204
	Small	<input type="checkbox"/> AXYS-CCP3L \$204	<input type="checkbox"/> ONYX-CCP3L \$204	<input type="checkbox"/> LINX-CCP3L \$156	<input type="checkbox"/> LINX2-CCP3L \$194
		<input type="checkbox"/> AXYS-CCP3V \$204	<input type="checkbox"/> ONYX-CCP3V \$204	<input type="checkbox"/> LINX-CCP3V \$156	<input type="checkbox"/> LINX2-CCP3V \$194
		<input type="checkbox"/> AXYS-CCP2L \$194	<input type="checkbox"/> ONYX-CCP2L \$194	<input type="checkbox"/> LINX-CCP2L \$145	<input type="checkbox"/> LINX2-CCP2L \$182

CONTOUR CRADLE INFANT	<input type="checkbox"/> AXYS-CCS1 \$194	<input type="checkbox"/> ONYX-CCS1 \$194	N/A
------------------------------	--	--	------------

Head Positioning - Use HCPCS Code E0955

Whitmyer headrests come unassembled. Please add item WHITASSY001 if the dealer would like parts assembled. This is a no charge option.





	<input type="checkbox"/> Receiver must be selected on pg 2		<input type="checkbox"/> Adult - 15" <input type="checkbox"/> Peds - 11" <input type="checkbox"/> EI - 10"		<input type="checkbox"/> Adult - 15" <input type="checkbox"/> Peds - 11" <input type="checkbox"/> EI - 10"
PAD	PRO	COBRA		COBRA-FB	

CONTOUR CRADLE	Large	<input type="checkbox"/> PRO-CCS4L \$247	<input type="checkbox"/> COBRA-CCS4L \$463	<input type="checkbox"/> FB-COBRA-CCS4L \$568
	Medium	<input type="checkbox"/> PRO-CCS4V \$247	<input type="checkbox"/> COBRA-CCS4V \$463	<input type="checkbox"/> FB-COBRA-CCS4V \$568
	Small	<input type="checkbox"/> PRO-CCS3L \$247	<input type="checkbox"/> COBRA-CCS3L \$463	<input type="checkbox"/> FB-COBRA-CCS3L \$568
		<input type="checkbox"/> PRO-CCS3V \$247	<input type="checkbox"/> COBRA-CCS3V \$463	<input type="checkbox"/> FB-COBRA-CCS3V \$568
		<input type="checkbox"/> PRO-CCS2L \$247	<input type="checkbox"/> COBRA-CCS2L \$463	<input type="checkbox"/> FB-COBRA-CCS2L \$568

C-PLUSH	Large	<input type="checkbox"/> PRO-CCP4L \$247	<input type="checkbox"/> COBRA-CCP4L \$463	<input type="checkbox"/> FB-COBRA-CCP4L \$568
	Medium	<input type="checkbox"/> PRO-CCP4V \$247	<input type="checkbox"/> COBRA-CCP4V \$463	<input type="checkbox"/> FB-COBRA-CCP4V \$568
	Small	<input type="checkbox"/> PRO-CCP3L \$247	<input type="checkbox"/> COBRA-CCP3L \$463	<input type="checkbox"/> FB-COBRA-CCP3L \$568
		<input type="checkbox"/> PRO-CCP3V \$247	<input type="checkbox"/> COBRA-CCP3V \$463	<input type="checkbox"/> FB-COBRA-CCP3V \$568
		<input type="checkbox"/> PRO-CCP2L \$247	<input type="checkbox"/> COBRA-CCP2L \$463	<input type="checkbox"/> FB-COBRA-CCP2L \$568





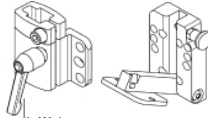
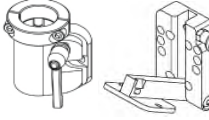
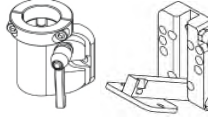
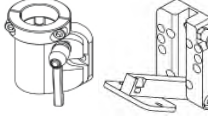



Mounting Brackets - Use HCPCS Code E1028

Head Support System Mounting Brackets must be ordered separately, except for COBRA



	AXYS	ONYX	LINX & LINX ²	PRO	COBRA mounting system includes detachable mounting bracket
REMOVABLE MOUNTING BRACKET (PART SOLD SEPARATELY FROM POST & PAD)					
Detachable	<input type="checkbox"/> M2500 \$113	<input type="checkbox"/> M2100-WB \$92	<input type="checkbox"/> M2300 \$177	<input type="checkbox"/> M2200-WB \$199	
REMOVABLE & SWING-AWAY MNT BRACKET (PART SOLD SEPARATELY FROM POST & PAD)					
Swing-Away	<input type="checkbox"/> M5500 \$215	<input type="checkbox"/> M5100 \$199	<input type="checkbox"/> M5300 \$284	<input type="checkbox"/> M5200 \$305	

Lateral Facial Supports

Note: Cover Selection - Add L = Lycra or V = Dartex Reversed (Example: LFC-PLL)

									
	2"	2.25" x 5"	2.25" x 7"	4" x 6"	2" x 6"	1.75" x 5"	1.25" x 4"		
	SPOT	STANDARD	LONG	OVAL	LARGE-C	MED-C	SMALL-C	FSO-B	
Unilateral	<input type="checkbox"/> LFC10-CSL \$236 LM115 \$86	<input type="checkbox"/> LFC15-CSL \$236 LM115 \$86	<input type="checkbox"/> LFC20-CSL \$236 LM115 \$86	<input type="checkbox"/> LFC25-CSL \$236 LM115 \$86	<input type="checkbox"/> LFC30-CSL \$236 LM115 \$86	<input type="checkbox"/> LFC35-CSL \$236 LM115 \$86	<input type="checkbox"/> LFC40-CSL \$236 LM115 \$86	<input type="checkbox"/> LFC80-CS \$260 LM115 \$86	
	<input type="checkbox"/> LFC10-CSV \$236 LM115 \$86	<input type="checkbox"/> LFC15-CSV \$236 LM115 \$86	<input type="checkbox"/> LFC20-CSV \$236 LM115 \$86	<input type="checkbox"/> LFC25-CSV \$236 LM115 \$86	<input type="checkbox"/> LFC30-CSV \$236 LM115 \$86	<input type="checkbox"/> LFC35-CSV \$236 LM115 \$86	<input type="checkbox"/> LFC40-CSV \$236 LM115 \$86		
	<input type="checkbox"/> LFC10-CS2L \$440 LM115 \$86	<input type="checkbox"/> LFC15-CS2L \$440 LM115 \$86	<input type="checkbox"/> LFC20-CS2L \$440 LM115 \$86	<input type="checkbox"/> LFC25-CS2L \$440 LM115 \$86	<input type="checkbox"/> LFC30-CS2L \$440 LM115 \$86	<input type="checkbox"/> LFC35-CS2L \$440 LM115 \$86	<input type="checkbox"/> LFC40-CS2L \$440 LM115 \$86		<input type="checkbox"/> LFC80-CS2 \$478 LM115 \$86
	<input type="checkbox"/> LFC10-CS2V \$440 LM115 \$86	<input type="checkbox"/> LFC15-CS2V \$440 LM115 \$86	<input type="checkbox"/> LFC20-CS2V \$440 LM115 \$86	<input type="checkbox"/> LFC25-CS2V \$440 LM115 \$86	<input type="checkbox"/> LFC30-CS2V \$440 LM115 \$86	<input type="checkbox"/> LFC35-CS2V \$440 LM115 \$86	<input type="checkbox"/> LFC40-CS2V \$440 LM115 \$86		
Pad Only*	<input type="checkbox"/> PL10L \$76	<input type="checkbox"/> PL15L \$107	<input type="checkbox"/> PL20L \$107	<input type="checkbox"/> P600L \$107	<input type="checkbox"/> PL30L \$107	<input type="checkbox"/> PL35L \$107	<input type="checkbox"/> PL40L \$97	N/A	
	<input type="checkbox"/> PL10V \$76	<input type="checkbox"/> PL15V \$107	<input type="checkbox"/> PL20V \$107	<input type="checkbox"/> P600V \$107	<input type="checkbox"/> PL30V \$107	<input type="checkbox"/> PL35V \$107	<input type="checkbox"/> PL40V \$97		

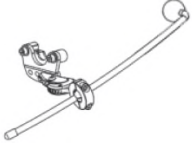
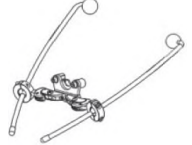
Lateral Facial Supports

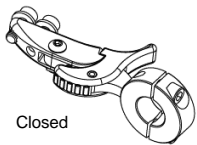

MOUNTING HARDWARE					
	Unilateral	Bilateral	Infinity Mount	Swing-Away Mount	LM115

LATERAL FACIAL SUPPORT PARTS

*Note: If ordering an additional Lateral Facial Support, select both a Lateral Facial Support Pad Only from above and an Infinity Mount from below as well

✓	Option #	Definition	Price
<input type="checkbox"/>	242161	Infinity Dual Mount Assembly*	\$209
<input type="checkbox"/>	LM1010	Lateral Facial Support*	\$135

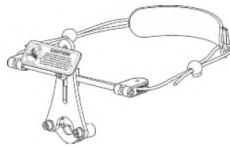
ANTERIOR HEAD SUPPORT

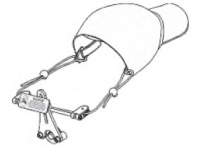
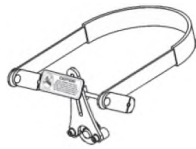
												
DYNAMIC FOREHEAD STRAP		DFS²		STRAP CAP		STATIC FOREHEAD STRAP						
ADULT	<input type="checkbox"/>	DFS10	\$310	<input type="checkbox"/>	DFSQ10	\$375	<input type="checkbox"/>	CAP10 (black)	\$429	<input type="checkbox"/>	HU10	\$338
PEDS	<input type="checkbox"/>	DFS30	\$310	<input type="checkbox"/>	DFSQ30	\$375	<input type="checkbox"/>	CAP30-R (red)	\$429			
							<input type="checkbox"/>	CAP30-B (blue)	\$429			

MOUNTING OPTIONS

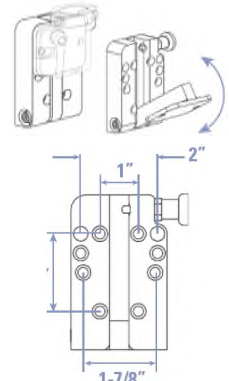
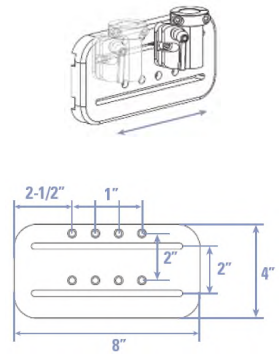
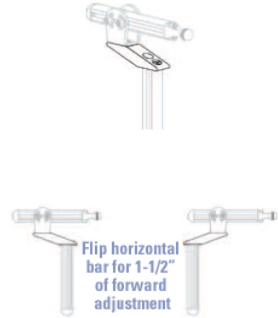
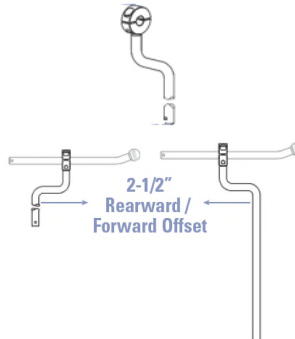
				
FLEX INTERFACE BRACKET	UNIVERSAL SWING-AWAY MOUNT	SLIDE MOUNT	PRO OFF-SET MOUNTING SYSTEM	ONYX REARWARD OFF-SET VERTICAL ROD
<input type="checkbox"/> M9450 (hard) \$199 <input type="checkbox"/> M9451 (soft) \$199	<input type="checkbox"/> M5000 \$107	<input type="checkbox"/> M7010 \$102	<input type="checkbox"/> PRC7070 \$175	<input type="checkbox"/> OX6030 \$65

TOOLS

Option #	Definition	Price
<input type="checkbox"/> BOLT LUBE	Bolt Lube	\$8.00
<input type="checkbox"/> T2500	Tool Kit	\$6.00

Pad Styles

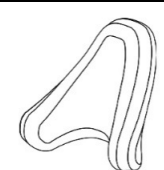
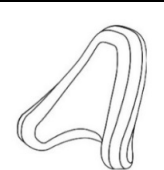
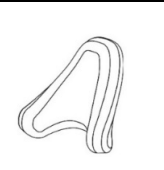
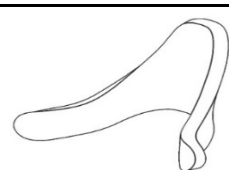
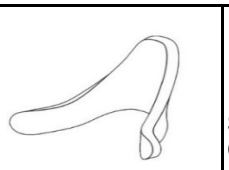
C-PLUSH	Large CCP4 7"w X 5"h		Medium CCP3 6"w X 4-1/2"h		Small CCP2 5"w X 4"h	
	CONTOUR CRADLE	Large CCS4 13"w X 7-1/2"h		Medium CCS3 10"w X 6-1/4"h		Small CCS2 8-1/2"w X 5-1/2"h



Sunrise Medical (US) LLC
2842 Business Park Ave. · Fresno, CA 93727 · USA