

SERIAL NO: _____

AI
ALUMINIUM 7020



CE

Customer Contact Details

Customer Name: _____

Advisor: _____

Address: _____

Phone: _____

Email: _____

Ship to Customer Address:

Shipping Name: _____

Shipping Address: _____

Phone: _____

Email: _____

Additional Information

Notes: _____

Current Wheelchair: _____

Customer Weight: _____

Customer Height: _____

Customer Disability: _____

Other

VAT Exemption Declaration (UK Only):

I declare that I am chronically sick or disabled by reason of:

and that I am receiving from RGK Wheelchairs Ltd, the wheelchair specified herein and I claim relief from Value Added Tax under group 12 of schedule 8 to Value Added Tax Act 1994.

Signature: _____ Date: _____

RGK Contact Authorisation:

From time to time, RGK would like to send you exclusive information, news and offers on everything RGK, by email or post. We will not pass any of your details to any third party.

I would like to be contacted by RGK:

Signature: _____ Date: _____

Guide:

- Base product
- Required option
- Optional Extra
- Critical Information
- Information Needed

PRODUCT STYLE

- GSAXZ010 GRANDSLAM**
\$4,873.00

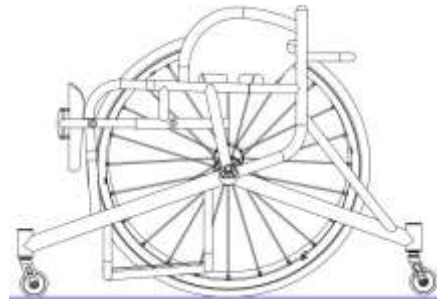

Max User Weight 125kg (275lbs)

PLEASE NOTE: ALL RGK CHAIRS ARE HAND BUILT AND HAVE A MANUFACTURING MEASUREMENT TOLERANCE OF +/- 5MM

CAD APPROVAL

- | | |
|---|--|
| <ul style="list-style-type: none"> <input type="checkbox"/> XW009 QUOTE ONLY (NO CAD FOR APPROVAL)
\$0.00 <input type="checkbox"/> XW012 QUOTE CAD drawing for approval
\$405.00 (2 customer amendments ONLY) | <ul style="list-style-type: none"> <input type="checkbox"/> XW011 ORDER (NO CAD FOR APPROVAL)
\$0.00 <input type="checkbox"/> XW010 ORDER CAD drawing for approval
\$250.00 (2 customer amendments ONLY) |
|---|--|

KEY MEASUREMENTS

- XY010 Seat width *(Inside to inside of sideguards)*
 (Max - 500mm)
- XY020 Seat length
 (Max - 500mm)
- XY030 Extra seat length *(NOT WITH WITH KNEE SUPPORT XA200)*
- XY050 Front frame height
 (Max - 630mm)
(Min - 360mm)
- XY060 Rear frame height
 (Max - 630mm)
(Min - 360mm)
- XY070 Frame length
 (Min XY020 + XY030 + 110mm)
- XA020 Ergonomic seat
\$77.00
 Specify length
 (Standard = 120mm)

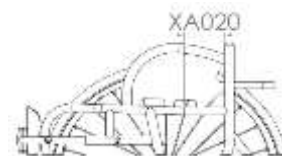
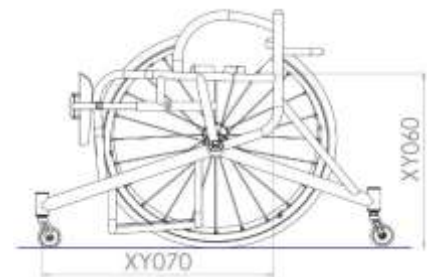
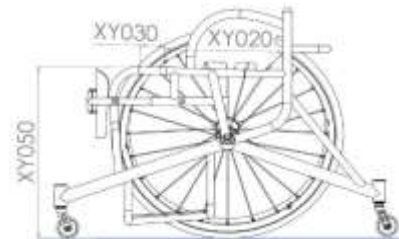
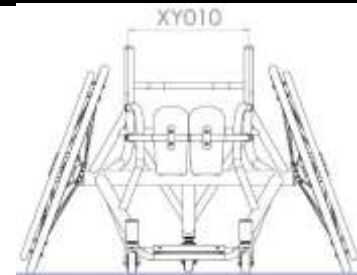

FRAME OPTIONS

Front Frame Options (Choose One)

XY080 Seat taper design

i Specify taper width
 mm



XA130 V-seat design
 \$204.00

i Specify taper width
 mm
NOTE: INSIDE TO INSIDE WHEEL (XY470) REQUIRED

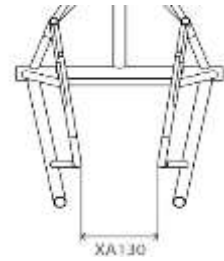

XA136 Frame front seat parallel design
 \$80.00

i Specify width
 mm

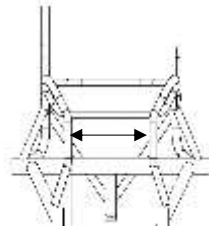

XA131 V-seat and Seat Taper Design
 \$275.00

Specify inside width at front of sideguard (A)
 mm

Specify taper width (B)
 mm

NOTE: INSIDE TO INSIDE WHEEL (XY470) REQUIRED

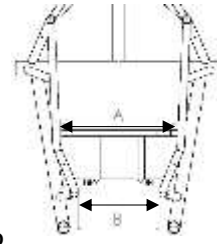

Knee Support Options

XA200 Knee support ratchet system
 (Tubes on the **outside**)

i Specify length
 mm

Optimise (Smallest)

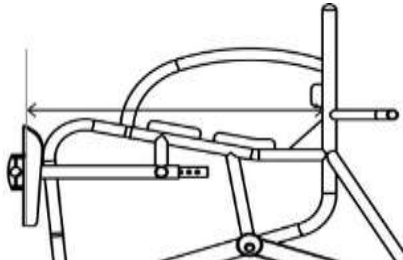

XA202 Plastic shin pads
 (Includes 5mm hard padding)

XA203 Carbon fibre shin pads
 \$328.00 (Includes 7mm hard padding)

XA204 Extra padding + cover for shin pads
 \$80.00

i Specify padding thickness
 mm

Specify padding density

Med Hard

Seat Options

XR040 Aluminum seat plate
 \$127.00 (riveted to frame)

i Specify length of plate
 mm (Std XY020 - 20mm)

XR050 Carbon fibre seat plate
 \$324.00 (riveted to frame)



i Specify length of plate
 mm (Std XY020 - 20mm)

FOOTREST

Fixed Footrest

- GSAXB080 Fixed position footrest

Height and Position

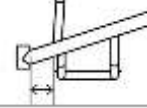
- Front footrest height
 mm (min = 35mm) 
- Rear footrest height
 mm (min = 35mm) 
- Footrest position
 (front of footplate to castor pot)
 mm 

Footrest Size

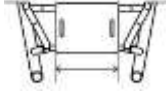
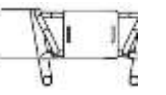
- Footrest width
 mm (Std = 200mm) 
- Footrest length
 mm (Std = 250mm) 



Footrest Plate

- XB180 Aluminium footplate (2.5mm)
- XB190 Carbon fibre footplate \$211.00
- XB100 ABS moulded foot tray \$124.00
 Specify length
 mm (Max = 380mm (Full) Std = 330mm) 
- GSAXB140 Spacer kit \$18.00
 (Allows for 25mm increase in height)

Adjustable Footrest

- GSAXB130 Adjustable position footrest \$204.00

Height and Position

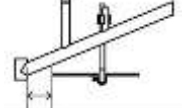
- Front footrest height
 mm (min = 40mm) 
- Rear footrest height
 mm (min = 40mm) 
- Footrest position
 (front of footplate to castor pot)
 mm 

Footrest Size (Not ABS)

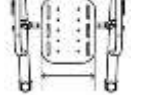
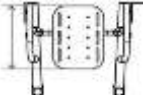
- Footrest width
 mm (Std = 200mm) 
- Footrest length
 mm (Std = 250mm) 

Footrest Plate

- XB180 Aluminium footplate (5mm)
- XB100 ABS moulded foot tray \$124.00
 Specify length
 mm (Max = 380mm (Full) Std = 330mm) 

Footrest Plate Options

- XB240 Aluminium raised edges \$72.00 (Cost per Edge)
 Front Back Left Right
 Specify height
 mm (Max = 60mm)

- XB250 Carbon Fibre raised edge \$279.00 (1 side only)
 Front Back
 Specify height
 mm (Max = 45mm)

Castor Pin Width

- XY330 Castor pin width
 mm 
- Optimise measurements



CAMBER BAR & ANTI-TIP

Centre of Gravity

- GSAXY510 Fixed centre of gravity

Specify measurement
 mm

(Note: dimension is taken from front of backrest post to centre of axle)

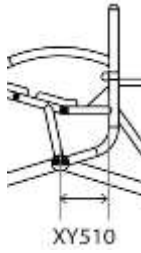

- GSAXY515 Backrest COG adjustment
 \$159.00
 (Not with welded sides)
 (+/-20mm)

Specify measurement
 mm

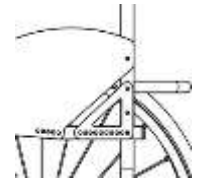

- GSAXY560 Adjustable centre of gravity
 \$226.00

Specify measurement
 mm

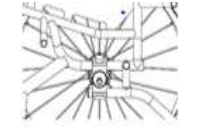

Camber Angle & Anti Tip

- XY390 Camber angle

Specify measurement
 18 20 22

- GSAXJ040 Single fixed anti tip

Specify distance behind rear wheel
 mm (Std = 100mm)



SIDEGUARDS

Sideguard Style

- GSAXE240 Welded aluminium sport
 \$360.00
- XE050 Screw on carbon fibre
 \$378.00

- XE030 Screw on aluminium
 \$169.00

Sideguard Measurements

- Sideguard length

Specify measurement
 mm

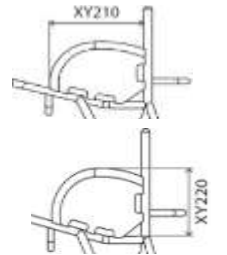

- Sideguard height

Specify measurement
 mm

- 25mm above tyre
 (Follow tyre)

- Individual above tyre
 (Follow tyre)

Specify measurement
 mm

- Level with tyre
 (Follow tyre)

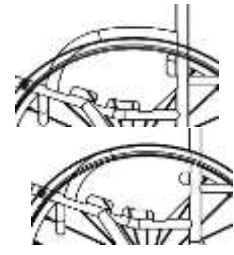

BACKREST

Backrest Height (Choose One)

- XY230 Fixed backrest height

Specify height
 mm

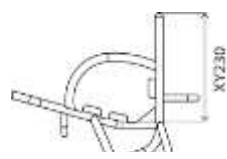

- XY245 Adjustable backrest height
 \$127.00
 (+/-25mm)

Specify height
 mm

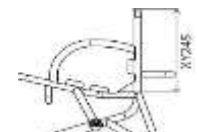

Ergonomic Options

- XY360 Backrest angle

Specify measurement
 -5 -3 0 +3 +5

Individual Deg
 (Max -10/+10 Deg)

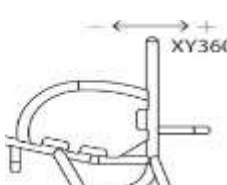

- XG100 Ergonomic backrest
 \$77.00

Vertical height
 mm

Rearward position
 mm

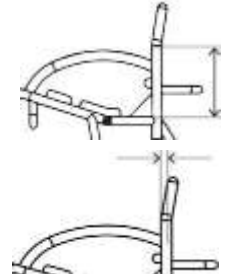

- XG110 Inward taper
 \$77.00
 (inside of backrest posts)

Specify width or per side
 mm



- XG120 Outward flare
 \$77.00
 (inside of backrest posts)

Specify width or per side
 mm

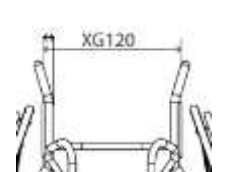

CASTORS AND REAR WHEELS

Castor Options

- | | |
|--|---|
| <input type="checkbox"/> XC160 Sport 61mm castor
(Std, Black) | <input type="checkbox"/> XC181 Bones Reds bearings
(All castor bearings) |
| <input type="checkbox"/> XC170 Sport 72mm castor
(Black) | <input type="checkbox"/> XC182 Bones Swiss Ceramic bearings
(All castor bearings)
\$267.00 |

Rear Wheel Size

- | | | | |
|---|---|---|--|
| <input type="checkbox"/> XY420 24" Wheels | <input type="checkbox"/> XY430 25" Wheels | <input type="checkbox"/> XY440 26" Wheels | <input type="checkbox"/> XY450 700C Wheels |
|---|---|---|--|

Rear Wheel Gap

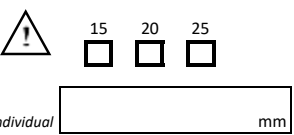
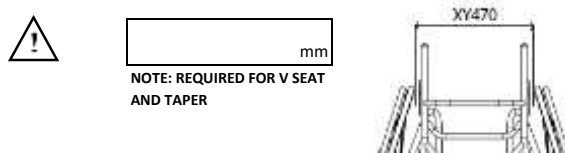
<input type="checkbox"/> XY460 Rear wheel gap 	OR	<input type="checkbox"/> XY470 Inside to inside of wheel 
Individual <input type="text" value="mm"/>		<input type="text" value="mm"/> NOTE: REQUIRED FOR V SEAT AND TAPER

Rear Wheel Options

- | | |
|--|--|
| <input type="checkbox"/> XK030 Equalizer 36/48 spoke
(Black hub and spokes) | <input type="checkbox"/> XK100 Spinergy XSLX 24 spoke
\$759.00 |
| <input type="checkbox"/> XK080 Spinergy SLX 24 spoke
\$721.00 | |

Spinergy Colour Options:

- | | | | |
|--|--|--|--|
| <input type="checkbox"/> Black spokes | <input type="checkbox"/> White spokes | <input type="checkbox"/> Yellow spokes | <input type="checkbox"/> XK180 Individual spoke design
\$169.00
(Specify colour)
Inside: _____
Outside: _____ |
| <input type="checkbox"/> Red spokes | <input type="checkbox"/> Blue spokes | <input type="checkbox"/> Pink spokes | |
| <input type="checkbox"/> Purple spokes | <input type="checkbox"/> Orange spokes | <input type="checkbox"/> Green spokes | |

Spinergy Anodise Options

- | | | | |
|---|---|---|---|
| <input type="checkbox"/> XK190 Black hub
(std option) | <input type="checkbox"/> XK200 Silver hub
\$88.00 | <input type="checkbox"/> XK201 Red hub/rims
\$263.00 | <input type="checkbox"/> XK205 Individual hub/rims
\$304.00
Select colour: _____ |
| <input type="checkbox"/> XK202 Purple hub/rims
\$263.00 | <input type="checkbox"/> XK203 Blue hub/rims
\$263.00 | <input type="checkbox"/> XK204 Gold hub/rims
\$263.00 | |

Supply Without Wheels

- | | | |
|--|----------------------------------|---------------------------------|
| <input type="checkbox"/> XK040 Supply without Wheels
-\$177.00 | Wheel Type: <input type="text"/> | Tyre Type: <input type="text"/> |
|--|----------------------------------|---------------------------------|

Handrim Position / Options

- | | |
|--|--|
| <input type="checkbox"/> XY480 Narrow set handrim | <input type="checkbox"/> XY485 Wide set handrim |
| <input type="checkbox"/> XL090 Remove excess mounting tabs
(recommended for small wheel gaps)
\$97.00 | <input type="checkbox"/> XL080 Super narrow set handrim
(only with XL040 and includes XL090)
\$195.00 |

Handrim Style

- | | |
|--|---|
| <input type="checkbox"/> XL010 Aluminium hard anodised 6 tab
(Select Colour) <input type="text"/> | <input type="checkbox"/> XL040 Titanium 6 tab
\$231.00
(700C not available) |
| <input type="checkbox"/> XL130 Aluminium hard anodised 6 tab Painted
\$64.00 | <input type="checkbox"/> XL100 Para grip 6 tab
\$272.00
(700C not available) |
| <input type="checkbox"/> XL070 Aluminium hard anodised 12 tab
(24" not available)
\$97.00 | <input type="checkbox"/> XL020 Tetra Grip 6 tab
\$272.00 |

Tyre Options

- | | |
|--|--|
| <input type="checkbox"/> XM070 Kenda Kaliente <input type="checkbox"/> Red <input type="checkbox"/> Blue | <input type="checkbox"/> XM095 Kenda Wide
\$34.00
(Grey Only) |
| <input type="checkbox"/> XM150 IRC Exeracer Pro
(Red Only)
\$80.00 | |
| <input type="checkbox"/> XM080 Tufo MS3 tubeless
(Blue only)
\$80.00 | |

Spare Wheel

- | | |
|--|---|
| <input type="checkbox"/> GSAXK500 Spare wheel Spinergy
(Built up + axle pin)
\$812.00 | <input type="checkbox"/> XK523 Spare wheel upcharge - Individual Hubs/Rims
\$117.00 |
| <input type="checkbox"/> XK520 Spare wheel upcharge - Titanium Rims
\$189.00 | <input type="checkbox"/> XK524 Spare wheel upcharge - Individual Spoke Colour
\$85.00 |
| <input type="checkbox"/> XK522 Spare wheel upcharge - Remove Excess Tabs
\$49.00 | |

Inner Tube Valve Options

- | | |
|---|--|
| <input type="checkbox"/> XY500 Schraeder inner tube valve  | <input type="checkbox"/> XY490 Presta inner tube valve
(Standard if no option selected)  |
|---|--|

FINISH OPTIONS

XN010 Powder coated frame XN150 Powder coated components (Frame colour if not specified)

Frame	Comp.	<u>Gloss</u>	Frame	Comp.	<u>Matt</u>	Frame	Comp.	<u>Special</u>
<input type="checkbox"/>	<input type="checkbox"/>	Black gloss 103	<input type="checkbox"/>	<input type="checkbox"/>	Black matt 105	<input type="checkbox"/>	<input type="checkbox"/>	Chrome Mirror 300
<input type="checkbox"/>	<input type="checkbox"/>	White gloss 100	<input type="checkbox"/>	<input type="checkbox"/>	White matt 101	<input type="checkbox"/>	<input type="checkbox"/>	Sparkle silver 170
<input type="checkbox"/>	<input type="checkbox"/>	Grey gloss 132	<input type="checkbox"/>	<input type="checkbox"/>	Grey matt 131	<input type="checkbox"/>	<input type="checkbox"/>	Metallic black matt 104
<input type="checkbox"/>	<input type="checkbox"/>	Cream gloss 135	<input type="checkbox"/>	<input type="checkbox"/>	Light grey matt 133	<input type="checkbox"/>	<input type="checkbox"/>	Metallic grey matt 130
<input type="checkbox"/>	<input type="checkbox"/>	Red gloss 108	<input type="checkbox"/>	<input type="checkbox"/>	Navy blue matt 152	<input type="checkbox"/>	<input type="checkbox"/>	Black sandpaper 201
<input type="checkbox"/>	<input type="checkbox"/>	Yellow gloss 120				<input type="checkbox"/>	<input type="checkbox"/>	Grey sandpaper 202
<input type="checkbox"/>	<input type="checkbox"/>	Forest green gloss 143				<input type="checkbox"/>	<input type="checkbox"/>	White sandpaper 200
<input type="checkbox"/>	<input type="checkbox"/>	Green gloss 107						
<input type="checkbox"/>	<input type="checkbox"/>	Dark blue gloss 151						
<input type="checkbox"/>	<input type="checkbox"/>	Royal blue gloss 154						
<input type="checkbox"/>	<input type="checkbox"/>	Blue gloss 174						
<input type="checkbox"/>	<input type="checkbox"/>	Duckegg blue gloss 141						
<input type="checkbox"/>	<input type="checkbox"/>	Pink gloss 188						
<input type="checkbox"/>	<input type="checkbox"/>	Orange gloss 180						
<input type="checkbox"/>	<input type="checkbox"/>	Purple gloss 157						

XN200 Individual paint colour (State Colour/RAL code)
\$165.00

Frame Comp

GSAXN030 Brushed frame
\$334.00 (All parts black unless XN160 chosen)

XN160 Brushed components
\$126.00 (not required with fixed footrest & backrest)

GSAXN050 Polished frame
\$884.00 (All parts black unless XN170 chosen)

XN170 Polished components
\$186.00 (not required with fixed footrest & backrest)

Accent Colour (Choose One)

Note: Accent colour includes, forks, castor caps, decals.

- Black accent Silver accent
 Red accent Blue accent
 Purple accent

XN250 Individual accent colour
\$165.00

Select Colour:

UPHOLSTERY

Seat Upholstery

XP040 Seat sling strap adjustable No seat sling (Seat Plate)

Backrest Upholstery

XP055 Airtech sport backrest strap adjustable XP070 Backrest upgrade to leather corners (Black)
\$115.00

Backrest Stitching Options

Silver Black Blue Individual:
 Red Orange Purple _____

Backrest RGK Logo Colour

White (Std) Green Blue Individual:
 Red Orange Purple _____

Backrest Accessories

XP170 Individual backrest embroidery
\$131.00 ADD DETAILS ON PAGE 9

CUSHION

Cushion Foam Options

- XP080** \$80.00 Cushion foam
(select density and size below)
- Soft (CMS040) Medium (CMS050)
- 50mm 75mm 100mm Other
- XP340** \$75.00 Hard Plastazote cushion upgrade
(Indicate max height)

Cushion Cover Options

- XP085** Nylon cushion cover (Black)
- XP090** \$62.00 Air Lite cushion cover (Black)
- XP380** \$85.00 Neoprene cushion cover (Black)

STRAPS

Velcro straps

- XS050** \$115.00 100mm Pro adjustable velcro strap
- XS055** \$115.00 50mm Pro adjustable velcro strap
- XS057** \$115.00 50mm Pro knee strap
(measurement from tube to tube over knees)

Velcro strap position

Strap 1

Specify strap length

Specify distance from back post

Strap 2

Specify strap length

Specify distance from back post

- XS020** \$78.00 Sport ratchet strap (Click strap)
(11" x 2" pad)
- XS021** \$78.00 Sport ratchet strap (Single)
- XS025** \$204.00 Pelvi Loc 2DA ratchet strap
(For thighs and knees)
- i** Select size:
 Medium (12") Large (14")
- XS030** \$218.00 Pelvi Loc 3DA ratchet strap
(For hips)
- i** Select size:
 S (8") M (12") L (14") XL (17")
- XS035** \$130.00 M2 ratchet strap
(For thighs and knees)
- i** 8" 10" 12"
- XS036** \$130.00 M2 ratchet strap (Single)
(For Feet)
- i** 8" 10" 12"

Strap 1

Specify distance from back post

Strap 2

Specify distance from back post

- XS040** \$82.00 Fixed mounting points
(one set per click strap) x1 x2 x3
- XS045** \$82.00 Clamped mounting points
(one set per click strap) x1 x2 x3

FRAME OPTIONS

- XR060** \$97.00 Calf strap mounting loops
- XR065** \$97.00 Strap location loops

ACCESSORIES

- XR030** \$96.00 Triple wheel bag (Black)
- XP130** \$87.00 Frame protectors full length
- XS100** \$87.00 Bodypoint waist strap Small Large
- XS070** Foot strap (select if required)
- XS060** Calf strap (select if required)
- XP400** Back bar protector
- XR090** Tool kit

ADDITIONAL NOTES

INDIVIDUAL BACKREST EMBROIDERY

PLEASE PROVIDE JPEG IMAGE AT TIME OF ORDER AND NOTE POSITION AND COLOUR BELOW



BRACE BAR

SPEC NOTES: