

SERIAL NO: _____

AI
ALUMINIUM 7020



CE

Customer Contact Details

Customer Name: _____

Advisor: _____

Address: _____

Phone: _____

Email: _____

Ship to Customer Address:

Shipping Name: _____

Shipping Address: _____

Phone: _____

Email: _____

Additional Information

Notes: _____

Current Wheelchair: _____

Customer Weight: _____

Customer Height: _____

Customer Disability: _____

Other

VAT Exemption Declaration (UK Only):
 I declare that I am chronically sick or disabled by reason of:

 and that I am receiving from RGK Wheelchairs Ltd, the wheelchair specified herein and I claim relief from Value Added Tax under group 12 of schedule 8 to Value Added Tax Act 1994.
 Signature: _____ Date: _____

RGK Contact Authorisation:
 From time to time, RGK would like to send you exclusive information, news and offers on everything RGK, by email or post. We will not pass any of your details to any third party.
 I would like to be contacted by RGK:
 Signature: _____ Date: _____

Guide:

- Base product
- Required option
- Optional Extra
- Critical Information
- Information Needed

PRODUCT STYLE

- PDAXZ010 PREDATOR**
\$7,835.00
- XA600 Heat treated frame
- XA240 Loose build fitting process
\$410.00

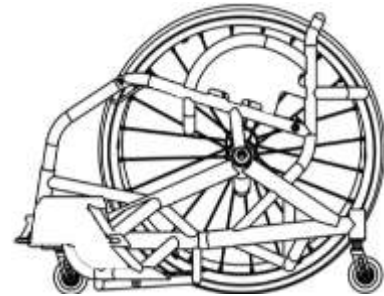

Max User Weight 125kg (275lbs)

PLEASE NOTE: ALL RGK CHAIRS ARE HAND BUILT AND HAVE A MANUFACTURING MEASUREMENT TOLERANCE OF +/- 5MM

CAD APPROVAL

- | | |
|--|---|
| <ul style="list-style-type: none"> <input type="checkbox"/> XW009 QUOTE ONLY (NO CAD FOR APPROVAL)
\$0.00 <input type="checkbox"/> XW012 QUOTE CAD drawing for approval
\$405.00
(2 customer amendments ONLY) | <ul style="list-style-type: none"> <input type="checkbox"/> XW011 ORDER (NO CAD FOR APPROVAL)
\$0.00 <input type="checkbox"/> XW010 ORDER CAD drawing for approval
\$250.00
(2 customer amendments ONLY) |
|--|---|

KEY MEASUREMENTS

- XY010 Seat width *(Inside to inside of sideguards)*
 mm
(Max - 500mm)
(Min - 250mm)
- XY020 Seat length
 mm
(Max - 500mm)
(Min - 250mm)
- XY030 Extra seat length *(Provides additional leg support & hand grip)*
 mm
- XY050 Front frame height
 mm
- XY060 Rear frame height
 mm
(Min - 280mm)
- XY070 Frame length
 mm
(Min = XY020 + XY030 + 140mm)
- XA020 Ergonomic seat
\$77.00
 Specify length
 mm
(Standard = 120mm)

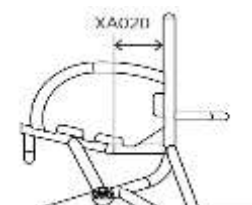
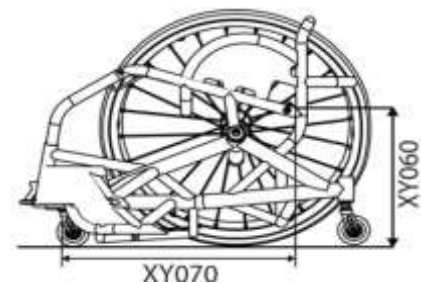
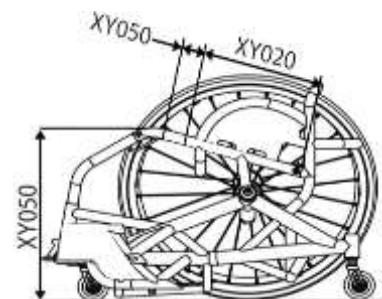
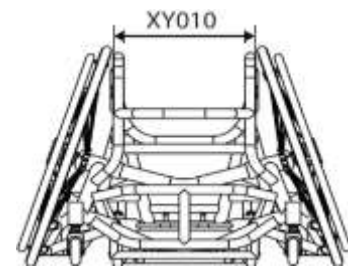

FRONT FRAME AND SEAT

Front Frame Options (Choose One)

XA061 Seat taper V-front design

Specify taper width
 mm

Specify front width
 mm (Std = 200mm)

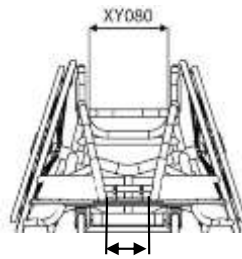

XA130 V-seat design
 \$204.00

Specify taper width
 mm

Specify front width
 mm (Std = 200mm)

NOTE: INSIDE TO INSIDE WHEEL (XY470) REQUIRED

FOOTREST

Fixed Footrest

PDAXB080 Fixed position footrest

Height and Position

Front footrest height
 mm (min = 35mm) 

Rear footrest height
 mm (min = 35mm) 

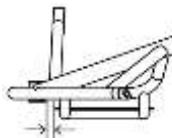
Footrest position (front of footplate to castor pot)
 mm 

Footrest Size (Not ABS)

Footrest width
 mm (Std= 200mm) 

Footrest length
 mm (Std = 250mm) 

Footrest Plate

XB180 Aluminium footplate 2.5mm

XB100 ABS moulded foot tray
 \$124.00
 Specify length
 mm (Max = 380mm (Full) Std = 330mm)

PDAXB140 Spacer kit
 \$18.00 (Allows for 25mm increase in height)

Adjustable Footrest

PDAXB130 Adjustable position footrest (Heavy duty)
 \$339.00

Height and Position

Front footrest height
 mm (min = 40mm) 

Rear footrest height
 mm (min = 40mm) 

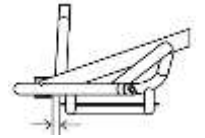
Footrest position (front of footplate to castor pot)
 mm 

Footrest Size (Not ABS)

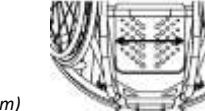
Footrest width
 mm (Std= 200mm) 

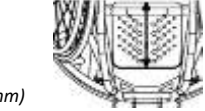
Footrest length
 mm (Std = 250mm) 

Footrest Plate

XB180 Aluminium footplate 5mm

XB100 ABS moulded foot tray
 \$124.00
 Specify length
 mm (Max = 380mm (Full) Std = 330mm)

Footrest Plate Options

XB240 Aluminium raised edges (Cost per Edge)
 \$72.00
 Front Back Left Right

Specify height
 (Max = 60mm)

Castor Pin Width

XY330 Castor pin width
 mm Optimise measurements

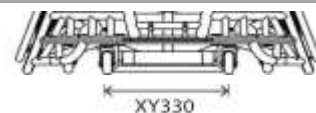

CAMBER BAR, WING AND ANTI-TIP

Fixed Centre of Gravity

PDAXY510 Fixed centre of gravity

mm

(dimension taken from front of back rest to centre of axle)

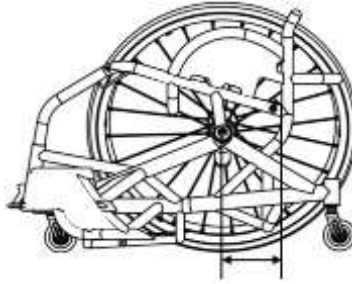

Specify Camber Angle

XY390 Camber angle

18
 (5/8" axle diameter only)

Wing Options (Choose one)

PDAXA126 **Defensive** rugby wing

PDAXA127 **Offensive** rugby wing
\$1,033.00 (select options below)

- Full upper wing Partial upper wing
- Full lower wing Partial lower wing

Wing details/drawings (use page 10 if req'd)

Picker Options (Choose one)

PDAXA400 **Defensive** rugby picker bolt on
\$842.00 (Draw requirements in opposite box)

PDAXA450 **Offensive** rugby picker fixed
\$252.00 (Draw requirements in opposite box)

Specify width (max 200mm)

mm

Specify depth

mm

Picker details/drawings (use page XX if req'd)

Anti-tip options

PDAXJ060 Anti tip double sport welded

XJ300 Anti tip low mount cross bar
\$80.00

PDAXJ200 Anti tip aluminium welded plate covers
\$353.00

PDAXJ210 Anti tip plastic plate covers
\$259.00

SIDEGUARDS

Sideguard Style

- PDAXE230 Welded aluminium sport
\$361.00
- XE310 High design upgrade
\$169.00
(Only with option PDAXE230)



- XE030 Screw on aluminium
\$169.00
- PDAXE250 Welded aluminium tubes only
\$168.00

Sideguard Measurements

- Sideguard length
- Sideguard height

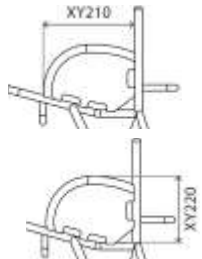

- Individual above tyre
(Follow tyre)
- Individual below tyre
(Follow tyre)
- Level with tyre
(Follow tyre)

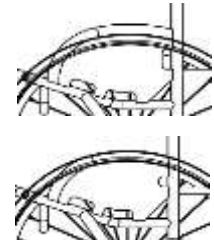

Sideguard Design (Choose One)

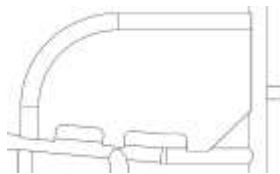

Straight design

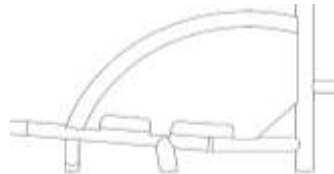

Round design



Follow tyre

BACKREST

Backrest Height (Choose One)

- XY230 Fixed backrest height
Specify height

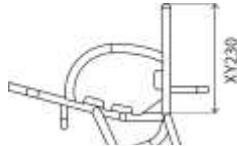

- XY245 Adjustable backrest height
\$127.00
(+/-25mm)
Specify height

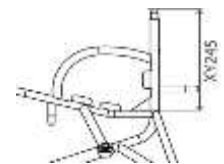

Ergonomic Options

- XY360 Backrest angle
-5 -3 0 +3 +5
Individual
(Max -10/+10 Deg)

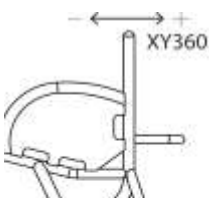

- XG100 Ergonomic backrest
\$77.00
Vertical height

Rearward position

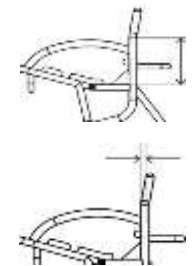

- XG110 Inward taper
\$77.00
(inside of backrest posts)
Specify width or per side

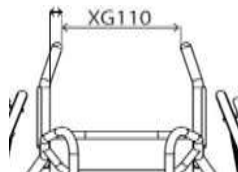

- XG120 Outward flare
\$77.00
(inside of backrest posts)
Specify width or per side

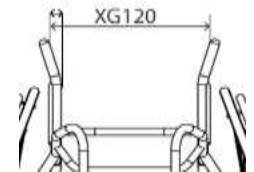

CASTOR AND REAR WHEELS			
Castor Wheels & Forks			
<input type="checkbox"/> XC160	Sport 61mm castor <i>(Black)</i>	<input type="checkbox"/> XC200	Sport micro fork <i>(Black)</i>
<input type="checkbox"/> XC170	Sport 72mm castor <i>(Black)</i>	<input type="checkbox"/> XC181	Castor wheel bearing Bones Reds
REAR WHEELS			
Rear Wheel Size			
<input type="checkbox"/> XY420	24" Wheels	<input type="checkbox"/> XY430	25" Wheels
Wheel Gap (Choose one)			
<input type="checkbox"/> XY460	Rear wheel gap	<input type="checkbox"/> XY470	Inside to inside of wheel
<div style="display: flex; justify-content: space-around; width: 100px;"> -10-5051015 </div> <div style="border: 1px solid black; width: 100px; height: 20px; margin-top: 5px; position: relative;"> Individual mm </div>	<p>OR</p>	<div style="border: 1px solid black; width: 100px; height: 20px; margin-top: 5px; position: relative;"> mm </div> <p style="font-size: 8px; margin-top: 5px;">NOTE: REQUIRED FOR V SEAT AND TAPER</p>	
Rear Wheel Options			
<input type="checkbox"/> XK331	Spinergy SLX R10 heavy duty 24 spoke <i>(Defensive & Offensive)</i>	<input type="checkbox"/> PDAXK333	Spinergy XSLX R10 heavy duty 24 spoke \$71.00 <i>(Offensive)</i>
Spinergy Colour Options			
<input type="checkbox"/> Black spokes	<input type="checkbox"/> White spokes	<input type="checkbox"/> Yellow spokes	<input type="checkbox"/> XK180 Individual spoke design \$169.00 <i>(Specify colour)</i> Inside: _____ Outside: _____
<input type="checkbox"/> Red spokes	<input type="checkbox"/> Blue spokes	<input type="checkbox"/> Pink spokes	
<input type="checkbox"/> Purple spokes	<input type="checkbox"/> Orange spokes	<input type="checkbox"/> Green spokes	
Supply Without Wheels			
<input type="checkbox"/> PDAXK040	Supply without Wheels -\$626.00	Wheel Type: <input style="width: 150px;" type="text"/>	
Handrim Position / Options			
<input type="checkbox"/> XL075	Narrow set handrim \$97.00 <i>(10mm gap with tabs cut off)</i>	<input type="checkbox"/> XL085	On rim handrim \$242.00 <i>(No gap, tabs cut off)</i>
<input type="checkbox"/> XL080	Super narrow set handrim \$195.00 <i>(5mm gap with tabs cut off)</i>		
Handrim Style			
<input type="checkbox"/> XL010	Aluminium hard anodised 6 tab	<input type="checkbox"/> XL200	Red Rubber Coated \$495.00
<input type="checkbox"/> XL070	Aluminium hard anodised 12 tab \$97.00 <i>(24" not available)</i>	<input type="checkbox"/> XL050	Stainless steel 6 tab \$127.00
Handrim spokeguard Options			
<input type="checkbox"/> XL500	Spokeguard poly dish offensive \$339.00 <i>(riveted to hand rim)</i>	<input type="checkbox"/> XL505	Spokeguard poly dish defensive \$269.00 <i>(mounted to wheel rim)</i>
		<input type="checkbox"/> XL515	Spokeguard poly dish raised defensive \$426.00 <i>(Only with XL200 and XK331)</i>
Tyre Options			
<input type="checkbox"/> XM010	Kenda	<input type="checkbox"/> Grey	<input type="checkbox"/> Red
		<input type="checkbox"/> Blue	<input type="checkbox"/> XM080
<input type="checkbox"/> XM075	Kenda Kaliente	<input type="checkbox"/> Red	<input type="checkbox"/> XM090
\$32.00		<input type="checkbox"/> Blue	Tufo MS3 tubeless \$80.00
			<input type="checkbox"/> XM090
			Tufo MS3 tubeless \$80.00 <i>(24" only)</i>
Spare Wheel			
<input type="checkbox"/> PDAXK500	Spare wheel Spinergy \$1,124.00 <i>(All inclusive + axle pin)</i>	<input type="checkbox"/> PDAXK525	Spare wheel upcharge - On rim handrim \$120.00
<input type="checkbox"/> XK524	Spare wheel upcharge - Individual Spoke Colour \$85.00	<input type="checkbox"/> PDAXK510	Spare axle pin 5/8" \$52.00
Inner Tube Valve Options			
<input type="checkbox"/> XY500	Schraeder inner tube valve	<input type="checkbox"/> XY490	Presta inner tube valve <i>(Standard if no option selected)</i>

FRAME FINISH

Frame Finish

PDAXN040 Raw Frame

Accent Colour (Choose One)

Note: Accent colour includes, forks, castor caps, and decals.

- | | | |
|--|--|---|
| <input type="checkbox"/> Black accent | <input type="checkbox"/> Silver accent | <input type="checkbox"/> XN250 Individual accent
\$165.00 |
| <input type="checkbox"/> Red accent | <input type="checkbox"/> Blue accent | Select Colour:
<div style="border: 1px solid black; height: 20px; width: 100%;"></div> |
| <input type="checkbox"/> Purple accent | | |

UPHOLSTERY

Seat Upholstery

PDAXP041 Seat sling strap adjustable HD

Backrest Upholstery

- | | |
|---|---|
| <input checked="" type="checkbox"/> PDAXP056 Airtech sport backrest strap adjustable HD | <input type="checkbox"/> XP070 Backrest upgrade to leather corners
\$115.00 (not with XG080) (Black) |
| <input type="checkbox"/> XP395 Nylon backrest centre pad | |

Backrest Accessories

XP170 Individual backrest embroidery
\$131.00 PLEASE COMPLETE PAGE 9

CUSHION

Cushion Options (choose one)

- XP080 **\$80.00** Cushion foam (select density and size below)
 - Soft (CMS040)
 - Medium (CMS050)
 - Hard (9lb recon)
 - 50mm
 - 75mm
 - 100mm
 - Other

Cushion Cover Upgrades

- XP085 Nylon cushion cover (Black)
- XP090 **\$62.00** Air Lite cushion cover (Black)

STRAPPING

Velcro straps

- XS050 **\$115.00** 100mm Pro adjustable velcro strap
- XS055 **\$115.00** 50mm Pro adjustable velcro strap
- XS057 **\$115.00** 50mm Pro adjustable velcro **Knee** strap (measurement from tube to tube over knees)

Velcro strap position

Strap 1

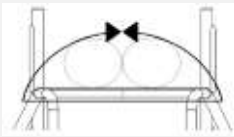

Specify strap length

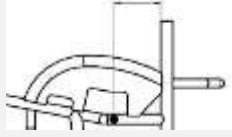

Specify distance from back post

Strap 1

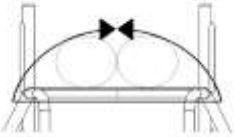

Specify strap length

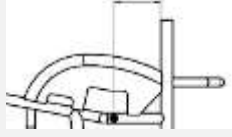

Specify distance from back post

Ratchet Straps

- XS020 **\$78.00** Sport ratchet strap (Click strap)
- XS025 **\$204.00** Pelvi Loc 2DA ratchet strap (For thighs and knees)
 - Select size: Medium (12") Large (14")
- XS030 **\$218.00** Pelvi Loc 3DA ratchet strap (For hips)
 - Select size: Small (8") Medium (12")
 - Large (14") Extra Large (17")
- XS035 **\$130.00** M2 ratchet strap (For thighs and knees)
 - Select size: 8" 10" 12"

Ratchet strap position

Strap 1

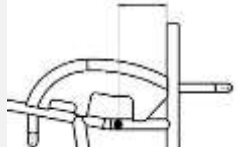

Specify distance from back post

Strap 2

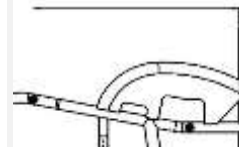

Specify distance from back post

- XS040 **\$82.00** Fixed mounting points (one set per click strap)
 - x1
 - x2
 - x3

FRAME OPTIONS

- XR060 **\$97.00** Calf strap mounting loops 
- XR065 **\$97.00** Strap location loops 

BALL HOLDER

- XR300 **\$96.00** Ball holder mounting points
 - Specify distance from back post
 -
- XR310 **\$165.00** Ball holder welded frame (please supply details on last page)
- XR320 **\$115.00** Ball holder fabric (please supply details on last page)

ACCESSORIES

- XR030 **\$96.00** Triple wheel bag (Black)
- XS070 Foot strap (select if required)
- XP130 **\$87.00** Frame protectors full length
- XS060 Calf strap (select if required)
- XP400 Back bar protector
- XR090 Tool kit

ADDITIONAL NOTES

INDIVIDUAL BACKREST EMBROIDERY

PLEASE PROVIDE JPEG IMAGE AT TIME OF ORDER AND NOTE POSITION BELOW

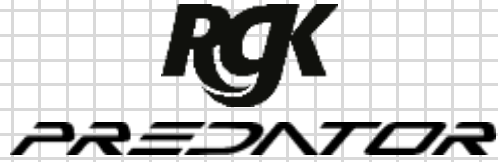

BRACE BAR

SPEC NOTES: