



JAY® J3 Posterior (PA) Backrest

E2613 (<22" Wide)

January 2017

Mark For: _____
 Date: _____
 Dealer Acct #: _____
 Dealer: _____
 Dealer Contact: _____
 Dealer Address: _____
 Dealer City: _____ ST: _____ ZIP: _____
 Dealer Phone: () _____ Fax: () _____
 Confirmation Email: _____
 Confirm Via: Fax Email

Submitting for: Quote Order
 PO#: _____

ADDITIONAL SHIPPING INFORMATION

Ship To: _____
 Attention: _____
 Address: _____
 Address: _____
 Ship To City: _____ ST _____ ZIP: _____
 Ship To Phone: () _____ Fax () _____

The **HCPCS CODES** provided are based on code verification through PDAC or our interpretation of the code definitions.
 The use of **HCPCS CODES** does not ensure coverage or payment. For coverage information, verify the appropriate payer's coverage policy.

JAY J3 Posterior (PA) BACK - E2613



BACKREST WIDTH	12"	14"	16"	18"	20"
BACKCANE WIDTHS	12"- 14"	14"- 16"	16"- 18"	18"- 20"	20"- 22"
MAX. USER TRUNK WIDTH	11"	13"	15"	17"	19"

Lower Thoracic (LT)				12"	14"	16"	18"	20"		
	6.5" (S)	J3PALTSxxSH	<input type="checkbox"/>	\$535	<input type="checkbox"/>	\$535	<input type="checkbox"/>	\$535		
		J3PALTSxxRH	<input type="checkbox"/>	\$535	<input type="checkbox"/>	\$535	<input type="checkbox"/>	\$535		
		J3PALTSxxRHF	<input type="checkbox"/>	\$535	<input type="checkbox"/>	\$535	<input type="checkbox"/>	\$535		
	8.0" (M)	J3PALTMxxSH	<input type="checkbox"/>	\$535	<input type="checkbox"/>	\$535	<input type="checkbox"/>	\$535		
		J3PALTMxxRH	<input type="checkbox"/>	\$535	<input type="checkbox"/>	\$535	<input type="checkbox"/>	\$535		
		J3PALTMxxRHF	<input type="checkbox"/>	\$535	<input type="checkbox"/>	\$535	<input type="checkbox"/>	\$535		
	9.5" (T)	J3PALTTxxSH	<input type="checkbox"/>	\$535	<input type="checkbox"/>	\$535	<input type="checkbox"/>	\$535	<input type="checkbox"/>	\$535
		J3PALTTxxRH	<input type="checkbox"/>	\$535	<input type="checkbox"/>	\$535	<input type="checkbox"/>	\$535	<input type="checkbox"/>	\$535
		J3PALTTxxRHF	<input type="checkbox"/>	\$535	<input type="checkbox"/>	\$535	<input type="checkbox"/>	\$535	<input type="checkbox"/>	\$535
Mid Thoracic (MT)				12"	14"	16"	18"	20"		
	12.0" (S)	J3PAMTSxxSH	<input type="checkbox"/>	\$535	<input type="checkbox"/>	\$535	<input type="checkbox"/>	\$535	<input type="checkbox"/>	\$535
		J3PAMTSxxFS	<input type="checkbox"/>	\$580	<input type="checkbox"/>	\$580	<input type="checkbox"/>	\$580	<input type="checkbox"/>	\$580
		J3PAMTSxxTH	<input type="checkbox"/>	\$580	<input type="checkbox"/>	\$580	<input type="checkbox"/>	\$580	<input type="checkbox"/>	\$580
	13.5" (M)	J3PAMTMxxSH	<input type="checkbox"/>	\$535	<input type="checkbox"/>	\$535	<input type="checkbox"/>	\$535	<input type="checkbox"/>	\$535
		J3PAMTMxxFS	<input type="checkbox"/>	\$580	<input type="checkbox"/>	\$580	<input type="checkbox"/>	\$580	<input type="checkbox"/>	\$580
		J3PAMTMxxTH	<input type="checkbox"/>	\$580	<input type="checkbox"/>	\$580	<input type="checkbox"/>	\$580	<input type="checkbox"/>	\$580
	15.0" (T)	J3PAMTTxxSH	<input type="checkbox"/>	\$535	<input type="checkbox"/>	\$535	<input type="checkbox"/>	\$535	<input type="checkbox"/>	\$535
		J3PAMTTxxFS	<input type="checkbox"/>	\$580	<input type="checkbox"/>	\$580	<input type="checkbox"/>	\$580	<input type="checkbox"/>	\$580
		J3PAMTTxxTH	<input type="checkbox"/>	\$580	<input type="checkbox"/>	\$580	<input type="checkbox"/>	\$580	<input type="checkbox"/>	\$580
Upper Thoracic (UT)				12"	14"	16"	18"	20"		
	16.5" (S)	J3PAUTSxxSH	<input type="checkbox"/>	\$535	<input type="checkbox"/>	\$535	<input type="checkbox"/>	\$535	<input type="checkbox"/>	\$535
		J3PAUTSxxFS	<input type="checkbox"/>	\$580	<input type="checkbox"/>	\$580	<input type="checkbox"/>	\$580	<input type="checkbox"/>	\$580
		J3PAUTSxxTH	<input type="checkbox"/>	\$580	<input type="checkbox"/>	\$580	<input type="checkbox"/>	\$580	<input type="checkbox"/>	\$580
	18.0" (M)	J3PAUTMxxSH	<input type="checkbox"/>	\$535	<input type="checkbox"/>	\$535	<input type="checkbox"/>	\$535	<input type="checkbox"/>	\$535
		J3PAUTMxxFS	<input type="checkbox"/>	\$580	<input type="checkbox"/>	\$580	<input type="checkbox"/>	\$580	<input type="checkbox"/>	\$580
		J3PAUTMxxTH	<input type="checkbox"/>	\$580	<input type="checkbox"/>	\$580	<input type="checkbox"/>	\$580	<input type="checkbox"/>	\$580
	19.5" (T)	J3PAUTTxxSH	<input type="checkbox"/>	\$535	<input type="checkbox"/>	\$535	<input type="checkbox"/>	\$535	<input type="checkbox"/>	\$535
		J3PAUTTxxFS	<input type="checkbox"/>	\$580	<input type="checkbox"/>	\$580	<input type="checkbox"/>	\$580	<input type="checkbox"/>	\$580
		J3PAUTTxxTH	<input type="checkbox"/>	\$580	<input type="checkbox"/>	\$580	<input type="checkbox"/>	\$580	<input type="checkbox"/>	\$580
Shoulder Height (SH)				14"	16"	18"	20"			
	21.0" (S)	J3PASHSxxSH	<input type="checkbox"/>	\$535	<input type="checkbox"/>	\$535	<input type="checkbox"/>	\$535		
		J3PASHSxxFS	<input type="checkbox"/>	\$580	<input type="checkbox"/>	\$580	<input type="checkbox"/>	\$580		
		J3PASHSxxTH	<input type="checkbox"/>	\$580	<input type="checkbox"/>	\$580	<input type="checkbox"/>	\$580		
	22.5" (M)	J3PASHMxxSH	<input type="checkbox"/>	\$535	<input type="checkbox"/>	\$535	<input type="checkbox"/>	\$535		
		J3PASHMxxFS	<input type="checkbox"/>	\$580	<input type="checkbox"/>	\$580	<input type="checkbox"/>	\$580		
		J3PASHMxxTH	<input type="checkbox"/>	\$580	<input type="checkbox"/>	\$580	<input type="checkbox"/>	\$580		
	24.0" (T)	J3PASHTxxSH	<input type="checkbox"/>	\$535	<input type="checkbox"/>	\$535	<input type="checkbox"/>	\$535		
		J3PASHTxxFS	<input type="checkbox"/>	\$580	<input type="checkbox"/>	\$580	<input type="checkbox"/>	\$580		
		J3PASHTxxTH	<input type="checkbox"/>	\$580	<input type="checkbox"/>	\$580	<input type="checkbox"/>	\$580		

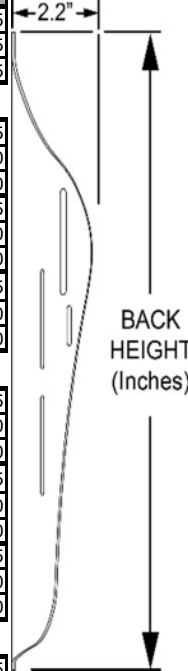

MOUNTING HARDWARE OPTIONS

SH

RH

RHF

TH

FS

Note: Hardware choices are not offered on every size of J3 Backrest, only options listed above are available.



JAY® J3 Posterior (PA) Backrest

E2614 (>22" Wide)

January 2017

Mark For:
 Date: _____
 Dealer Acct #: _____
 Dealer: _____
 Dealer Contact: _____
 Dealer Address: _____
 Dealer City: _____ ST: _____ ZIP: _____
 Dealer Phone: () _____ Fax: () _____
 Confirmation Email: _____
 Confirm Via: Fax Email

Submitting for: Quote Order
 PO#: _____

ADDITIONAL SHIPPING INFORMATION



Ship To: _____
 Attention: _____
 Address: _____
 Address: _____
 Ship To City: _____ ST: _____ ZIP: _____
 Ship To Phone: () _____ Fax () _____

The **HCPCS CODES** provided are based on code verification through PDAC or our interpretation of the code definitions.
 The use of **HCPCS CODES** does not ensure coverage or payment. For coverage information, verify the appropriate payer's coverage policy.

JAY J3 Posterior BACK - E2614

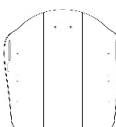
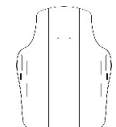

BACKREST WIDTH	22"	24"	26"
BACKCANE WIDTHS	22"-24"	24"-26"	26"-28"
MAX. USER TRUNK WIDTH	21"	23"	25"

Back Height	Lower Thoracic (LT)				
		6.5" (S)			
		8.0" (M)			
		9.5" (T)			
	Mid Thoracic (MT)				
		12.0" (S)	J3PAMTSxxFS <input type="checkbox"/> 22 \$795 <input type="checkbox"/> 24 \$795 <input type="checkbox"/> 26 \$795		
			J3PAMTSxxTH <input type="checkbox"/> 22 \$795 <input type="checkbox"/> 24 \$795 <input type="checkbox"/> 26 \$795		
		13.5" (M)			
	15.0" (T)	J3PAMTTxxFS <input type="checkbox"/> 22 \$795 <input type="checkbox"/> 24 \$795 <input type="checkbox"/> 26 \$795			
		J3PAMTTxxTH <input type="checkbox"/> 22 \$795 <input type="checkbox"/> 24 \$795 <input type="checkbox"/> 26 \$795			
	Upper Thoracic (UT)				
		16.5" (S)			
		18.0" (M)	J3PAUTMxxFS <input type="checkbox"/> 22 \$795 <input type="checkbox"/> 24 \$795		
			J3PAUTMxxTH <input type="checkbox"/> 22 \$795 <input type="checkbox"/> 24 \$795		
	19.5" (T)				
Shoulder Height (SH)					
	21.0" (S)	J3PASHSxxFS <input type="checkbox"/> 22 \$795			
		J3PASHSxxTH <input type="checkbox"/> 22 \$795			
	22.5" (M)				
24.0" (T)					

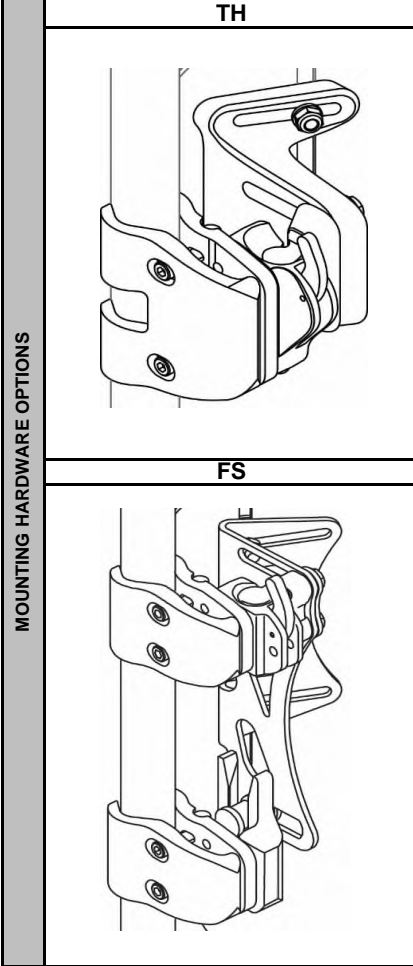
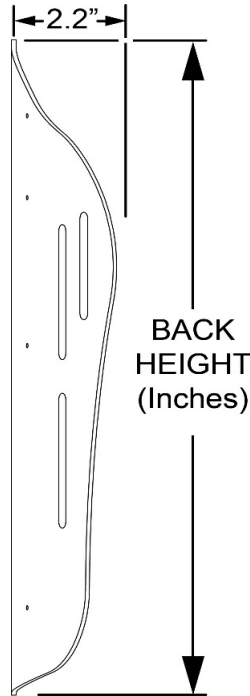

Note: Back shells 22"-26" will measure 1" to 4" shorter as the material has been removed to accommodate additional tissue. (MT std -1", MT tall -2", UT med -3", SH std -4")

Note: Hardware choices are not offered on every size of J3 Backrest, only options listed above are available.



JAY® J3 Posterior Lateral (PL) Backrest

E2615

January 2017

Mark For: _____ Date: _____ Dealer Acct #: _____ Dealer: _____ Dealer Contact: _____ Dealer Address: _____ Dealer City: _____ ST: _____ ZIP: _____ Dealer Phone: () _____ Fx () _____ Confirmation Email: _____ Confirm Via: <input type="checkbox"/> Fax <input type="checkbox"/> Email	Submitting for: <input type="checkbox"/> Quote <input type="checkbox"/> Order PO#: _____ ADDITIONAL SHIPPING INFORMATION Ship To: _____ Attention: _____ Address: _____ Address: _____ Ship To City: _____ ST: _____ ZIP: _____ Ship To Phone: () _____ Fax () _____
The HCPCS CODES provided are based on code verification through PDAC or our interpretation of the code definitions. The use of HCPCS CODES does not ensure coverage or payment. For coverage information, verify the appropriate payer's coverage policy.	



BACKREST WIDTH	12"	14"	16"	18"	20"
BACKCANE WIDTHS	12"- 14"	14"- 16"	16"- 18"	18"- 20"	20"- 22"
MAX. USER TRUNK WIDTH	9.5"	11.5"	13.5"	15.5"	17.5"

	Lower Thoracic (LT)		X	Y																
	6.5" (S)	8" (M)			9.5" (T)															
Back Height	Mid Thoracic (MT)		4.5"	5.5"	J3PLMTSxxSH	<input type="checkbox"/>	12	\$625	<input type="checkbox"/>	14	\$625	<input type="checkbox"/>	16	\$625	<input type="checkbox"/>	18	\$625	<input type="checkbox"/>	20	\$625
	12.0" (S)	J3PLMTSxxFS			<input type="checkbox"/>	12	\$670	<input type="checkbox"/>	14	\$670	<input type="checkbox"/>	16	\$670	<input type="checkbox"/>	18	\$670	<input type="checkbox"/>	20	\$670	
		J3PLMTSxxTH	<input type="checkbox"/>	12	\$670	<input type="checkbox"/>	14	\$670	<input type="checkbox"/>	16	\$670	<input type="checkbox"/>	18	\$670	<input type="checkbox"/>	20	\$670			
		J3PLMTMxxSH	<input type="checkbox"/>	12	\$625	<input type="checkbox"/>	14	\$625	<input type="checkbox"/>	16	\$625	<input type="checkbox"/>	18	\$625	<input type="checkbox"/>	20	\$625			
	13.5" (M)	J3PLMTMxxFS	<input type="checkbox"/>	12	\$670	<input type="checkbox"/>	14	\$670	<input type="checkbox"/>	16	\$670	<input type="checkbox"/>	18	\$670	<input type="checkbox"/>	20	\$670			
		J3PLMTMxxTH	<input type="checkbox"/>	12	\$670	<input type="checkbox"/>	14	\$670	<input type="checkbox"/>	16	\$670	<input type="checkbox"/>	18	\$670	<input type="checkbox"/>	20	\$670			
		J3PLMTTxxSH	<input type="checkbox"/>	12	\$625	<input type="checkbox"/>	14	\$625	<input type="checkbox"/>	16	\$625	<input type="checkbox"/>	18	\$625	<input type="checkbox"/>	20	\$625			
	15.0" (T)	J3PLMTTxxFS	<input type="checkbox"/>	12	\$670	<input type="checkbox"/>	14	\$670	<input type="checkbox"/>	16	\$670	<input type="checkbox"/>	18	\$670	<input type="checkbox"/>	20	\$670			
		J3PLMTTxxTH	<input type="checkbox"/>	12	\$670	<input type="checkbox"/>	14	\$670	<input type="checkbox"/>	16	\$670	<input type="checkbox"/>	18	\$670	<input type="checkbox"/>	20	\$670			
		Upper Thoracic (UT)		5.5"	7.5"	J3PLUTSxxSH	<input type="checkbox"/>	12	\$625	<input type="checkbox"/>	14	\$625	<input type="checkbox"/>	16	\$625	<input type="checkbox"/>	18	\$625	<input type="checkbox"/>	20
	16.5" (S)	J3PLUTSxxFS	<input type="checkbox"/>			12	\$670	<input type="checkbox"/>	14	\$670	<input type="checkbox"/>	16	\$670	<input type="checkbox"/>	18	\$670	<input type="checkbox"/>	20	\$670	
		J3PLUTSxxTH	<input type="checkbox"/>	12	\$670	<input type="checkbox"/>	14	\$670	<input type="checkbox"/>	16	\$670	<input type="checkbox"/>	18	\$670	<input type="checkbox"/>	20	\$670			
18.0" (M)		J3PLUTMxxSH	<input type="checkbox"/>	14	\$625	<input type="checkbox"/>	16	\$625	<input type="checkbox"/>	18	\$625	<input type="checkbox"/>	20	\$625						
	J3PLUTMxxFS	<input type="checkbox"/>	14	\$670	<input type="checkbox"/>	16	\$670	<input type="checkbox"/>	18	\$670	<input type="checkbox"/>	20	\$670							
	J3PLUTMxxTH	<input type="checkbox"/>	14	\$670	<input type="checkbox"/>	16	\$670	<input type="checkbox"/>	18	\$670	<input type="checkbox"/>	20	\$670							
19.5" (T)	J3PLUTTxxSH	<input type="checkbox"/>	14	\$625	<input type="checkbox"/>	16	\$625	<input type="checkbox"/>	18	\$625	<input type="checkbox"/>	20	\$625							
	J3PLUTTxxFS	<input type="checkbox"/>	14	\$670	<input type="checkbox"/>	16	\$670	<input type="checkbox"/>	18	\$670	<input type="checkbox"/>	20	\$670							
	J3PLUTTxxTH	<input type="checkbox"/>	14	\$670	<input type="checkbox"/>	16	\$670	<input type="checkbox"/>	18	\$670	<input type="checkbox"/>	20	\$670							
Shoulder Height (SH)		5.5"	8.5"	J3PLSHSxxSH	<input type="checkbox"/>	14	\$625	<input type="checkbox"/>	16	\$625	<input type="checkbox"/>	18	\$625	<input type="checkbox"/>	20	\$625				
21.0" (S)	J3PLSHSxxFS			<input type="checkbox"/>	14	\$670	<input type="checkbox"/>	16	\$670	<input type="checkbox"/>	18	\$670	<input type="checkbox"/>	20	\$670					
	J3PLSHSxxTH	<input type="checkbox"/>	14	\$670	<input type="checkbox"/>	16	\$670	<input type="checkbox"/>	18	\$670	<input type="checkbox"/>	20	\$670							
	22.5" (M)	J3PLSHMxxSH	<input type="checkbox"/>	16	\$625	<input type="checkbox"/>	18	\$625	<input type="checkbox"/>	20	\$625									
J3PLSHMxxFS		<input type="checkbox"/>	16	\$670	<input type="checkbox"/>	18	\$670	<input type="checkbox"/>	20	\$670										
J3PLSHMxxTH		<input type="checkbox"/>	16	\$670	<input type="checkbox"/>	18	\$670	<input type="checkbox"/>	20	\$670										
24.0" (T)	J3PLSHTxxSH	<input type="checkbox"/>	18	\$625	<input type="checkbox"/>	20	\$625													
	J3PLSHTxxFS	<input type="checkbox"/>	18	\$670	<input type="checkbox"/>	20	\$670													
	J3PLSHTxxTH	<input type="checkbox"/>	18	\$670	<input type="checkbox"/>	20	\$670													

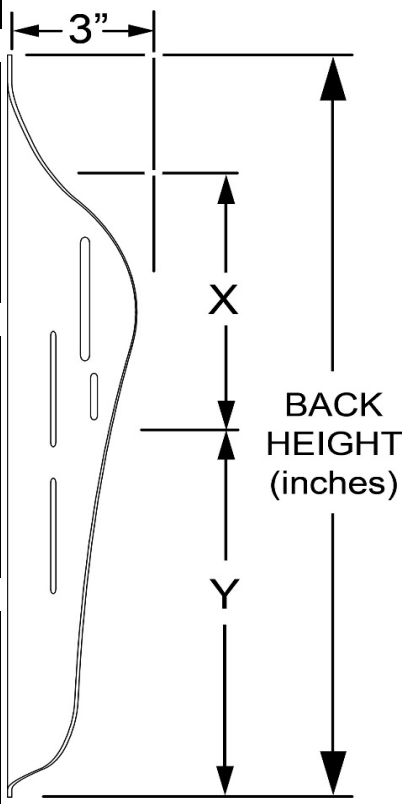

Note: Hardware choices are not offered on every size of J3 Backrest, only options listed above are available.

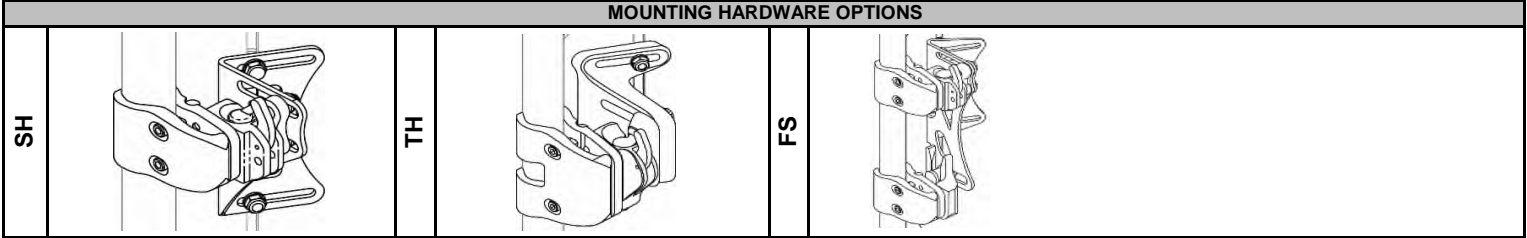



JAY® J3 Posterior Deep (PD) Backrest

E2620

January 2017

Mark For: _____ Date: _____ Dealer Acct #: _____ Dealer: _____ Dealer Contact: _____ Dealer Address: _____ Dealer City: _____ ST: _____ ZIP: _____ Dealer Phone: () _____ Fx () _____ Confirmation Email: _____ Confirm Via: <input type="checkbox"/> Fax <input type="checkbox"/> Email	Submitting for: <input type="checkbox"/> Quote <input type="checkbox"/> Order PO#: _____ ADDITIONAL SHIPPING INFORMATION Ship To: _____ Attention: _____ Address: _____ Address: _____ Ship To City: _____ ST: _____ ZIP: _____ Ship To Phone: () _____ Fax () _____
<p><i>The HCPCS CODES provided are based on code verification through PDAC or our interpretation of the code definitions. The use of HCPCS CODES does not ensure coverage or payment. For coverage information, verify the appropriate payer's coverage policy.</i></p> <p>JAY J3 Posterior Deep BACK - E2620</p>	



BACKREST WIDTH	14"	16"	18"	20"
BACKCANE WIDTHS	14"- 16"	16"- 18"	18"- 20"	20"- 22"
MAX. USER TRUNK WIDTH	11"	13"	15"	17"

Back Height	Lower Thoracic (LT)											
		6.5" (S)										
		8" (M)										
		9.5" (T)										
	Mid Thoracic (MT)											
		12.0" (S)	J3PDMTSxxSH	<input type="checkbox"/> 14	\$750	<input type="checkbox"/> 16	\$750	<input type="checkbox"/> 18	\$750	<input type="checkbox"/> 20	\$750	
			J3PDMTSxxFS	<input type="checkbox"/> 14	\$795	<input type="checkbox"/> 16	\$795	<input type="checkbox"/> 18	\$795	<input type="checkbox"/> 20	\$795	
			J3PDMTSxxTH	<input type="checkbox"/> 14	\$795	<input type="checkbox"/> 16	\$795	<input type="checkbox"/> 18	\$795	<input type="checkbox"/> 20	\$795	
		13.5" (M)										
			15.0" (T)	J3PDMTTxxSH	<input type="checkbox"/> 14	\$750	<input type="checkbox"/> 16	\$750	<input type="checkbox"/> 18	\$750	<input type="checkbox"/> 20	\$750
				J3PDMTTxxFS	<input type="checkbox"/> 14	\$795	<input type="checkbox"/> 16	\$795	<input type="checkbox"/> 18	\$795	<input type="checkbox"/> 20	\$795
	J3PDMTTxxTH	<input type="checkbox"/> 14		\$795	<input type="checkbox"/> 16	\$795	<input type="checkbox"/> 18	\$795	<input type="checkbox"/> 20	\$795		
	Upper Thoracic (UT)											
		16.5" (S)										
			18.0" (M)	J3PDUTMxxSH	<input type="checkbox"/> 14	\$750	<input type="checkbox"/> 16	\$750	<input type="checkbox"/> 18	\$750	<input type="checkbox"/> 20	\$750
J3PDUTMxxFS				<input type="checkbox"/> 14	\$795	<input type="checkbox"/> 16	\$795	<input type="checkbox"/> 18	\$795	<input type="checkbox"/> 20	\$795	
J3PDUTMxxTH		<input type="checkbox"/> 14	\$795	<input type="checkbox"/> 16	\$795	<input type="checkbox"/> 18	\$795	<input type="checkbox"/> 20	\$795			
19.5" (T)												
Shoulder Height (SH)												
	21.0" (S)	J3PDSHSxxSH	<input type="checkbox"/> 14	\$750	<input type="checkbox"/> 16	\$750	<input type="checkbox"/> 18	\$750	<input type="checkbox"/> 20	\$750		
		J3PDSHSxxFS	<input type="checkbox"/> 14	\$795	<input type="checkbox"/> 16	\$795	<input type="checkbox"/> 18	\$795	<input type="checkbox"/> 20	\$795		
		J3PDSHSxxTH	<input type="checkbox"/> 14	\$795	<input type="checkbox"/> 16	\$795	<input type="checkbox"/> 18	\$795	<input type="checkbox"/> 20	\$795		
	22.5" (M)											
24.0" (T)												

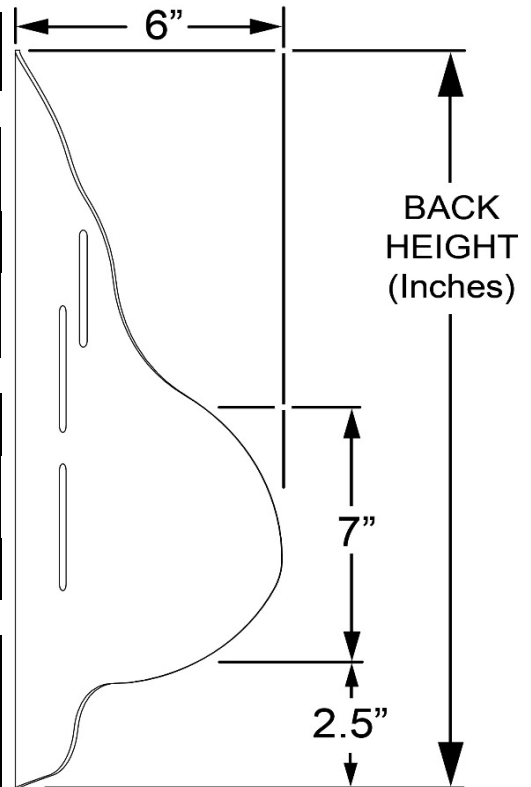

Note: Hardware choices are not offered on every size of J3 Backrest, only options listed above are available.

MOUNTING HARDWARE OPTIONS

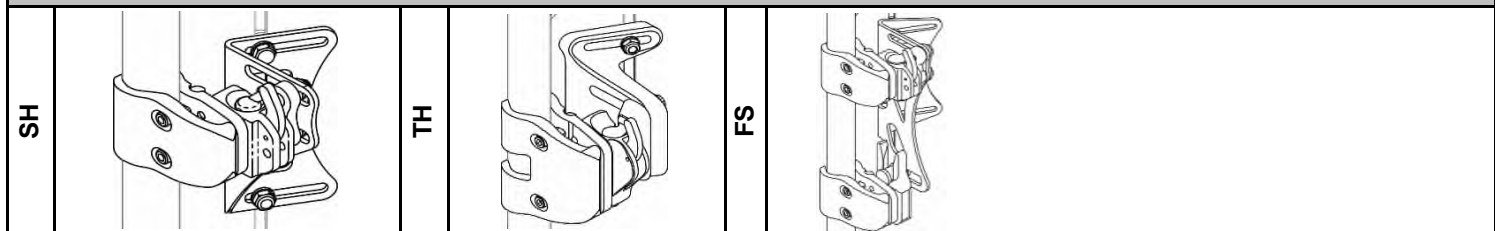



JAY® J3 Posterior Deep Lateral (PDL) Backrest

E2620

January 2017

Mark For: _____ Date: _____ Dealer Acct #: _____ Dealer: _____ Dealer Contact: _____ Dealer Address: _____ Dealer City: _____ ST: _____ ZIP: _____ Dealer Phone: () _____ Fx () _____ Confirmation Email: _____ Confirm Via: <input type="checkbox"/> Fax <input type="checkbox"/> Email	Submitting for: <input type="checkbox"/> Quote <input type="checkbox"/> Order PO#: _____ <p style="text-align: center;">ADDITIONAL SHIPPING INFORMATION</p> Ship To: _____ Attention: _____ Address: _____ Address: _____ Ship To City: _____ ST: _____ ZIP: _____ Ship To Phone: () _____ Fax () _____
--	--

The **HCPCS CODES** provided are based on code verification through PDAC or our interpretation of the code definitions.
 The use of **HCPCS CODES** does not ensure coverage or payment. For coverage information, verify the appropriate payer's coverage policy.

JAY J3 Posterior Deep Lateral BACK - E2620

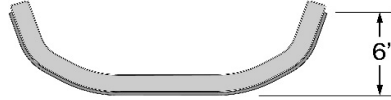

BACKREST WIDTH	14"	16"	18"	20"
BACKCANE WIDTHS	14"- 16"	16"- 18"	18"- 20"	20"- 22"
MAX. USER TRUNK WIDTH	11"	13"	15"	17"

Back Height	Lower Thoracic (LT)		X	Y										
		6.5" (S)												
		8.0" (M)												
		9.5" (T)												
	Mid Thoracic (MT)		X	Y										
		12.0" (S)												
		13.5" (M)												
		15.0" (T)												
	Upper Thoracic (UT)		X	Y										
		16.5" (S)	7.5"	5.8"	J3PDLUTSxxSH	<input type="checkbox"/> 14	\$750	<input type="checkbox"/> 16	\$750	<input type="checkbox"/> 18	\$750	<input type="checkbox"/> 20	\$750	
					J3PDLUTSxxFS	<input type="checkbox"/> 14	\$795	<input type="checkbox"/> 16	\$795	<input type="checkbox"/> 18	\$795	<input type="checkbox"/> 20	\$795	
					J3PDLUTSxxTH	<input type="checkbox"/> 14	\$795	<input type="checkbox"/> 16	\$795	<input type="checkbox"/> 18	\$795	<input type="checkbox"/> 20	\$795	
		18.0" (M)	8.3"	6.5"	J3PDLUTMxxSH	<input type="checkbox"/> 14	\$750	<input type="checkbox"/> 16	\$750	<input type="checkbox"/> 18	\$750	<input type="checkbox"/> 20	\$750	
					J3PDLUTMxxFS	<input type="checkbox"/> 14	\$795	<input type="checkbox"/> 16	\$795	<input type="checkbox"/> 18	\$795	<input type="checkbox"/> 20	\$795	
					J3PDLUTMxxTH	<input type="checkbox"/> 14	\$795	<input type="checkbox"/> 16	\$795	<input type="checkbox"/> 18	\$795	<input type="checkbox"/> 20	\$795	
19.5" (T)		9.3"	6.8"	J3PDLUTTxxSH	<input type="checkbox"/> 14	\$750	<input type="checkbox"/> 16	\$750	<input type="checkbox"/> 18	\$750	<input type="checkbox"/> 20	\$750		
				J3PDLUTTxxFS	<input type="checkbox"/> 14	\$795	<input type="checkbox"/> 16	\$795	<input type="checkbox"/> 18	\$795	<input type="checkbox"/> 20	\$795		
				J3PDLUTTxxTH	<input type="checkbox"/> 14	\$795	<input type="checkbox"/> 16	\$795	<input type="checkbox"/> 18	\$795	<input type="checkbox"/> 20	\$795		
Shoulder Height (SH)		X	Y											
	21.0" (S)	8"	6"	J3PDLSHSxxSH	<input type="checkbox"/> 14	\$750	<input type="checkbox"/> 16	\$750	<input type="checkbox"/> 18	\$750	<input type="checkbox"/> 20	\$750		
				J3PDLSHSxxFS	<input type="checkbox"/> 14	\$795	<input type="checkbox"/> 16	\$795	<input type="checkbox"/> 18	\$795	<input type="checkbox"/> 20	\$795		
				J3PDLSHSxxTH	<input type="checkbox"/> 14	\$795	<input type="checkbox"/> 16	\$795	<input type="checkbox"/> 18	\$795	<input type="checkbox"/> 20	\$795		
	22.5" (M)	8.8"	6.5"	J3PDLSHMxxSH			<input type="checkbox"/> 16	\$750	<input type="checkbox"/> 18	\$750	<input type="checkbox"/> 20	\$750		
				J3PDLSHMxxFS			<input type="checkbox"/> 16	\$795	<input type="checkbox"/> 18	\$795	<input type="checkbox"/> 20	\$795		
				J3PDLSHMxxTH			<input type="checkbox"/> 16	\$795	<input type="checkbox"/> 18	\$795	<input type="checkbox"/> 20	\$795		
	24.0" (T)	9.5"	7.3"	J3PDLSHTxxSH					<input type="checkbox"/> 18	\$750	<input type="checkbox"/> 20	\$750		
				J3PDLSHTxxFS					<input type="checkbox"/> 18	\$795	<input type="checkbox"/> 20	\$795		
				J3PDLSHTxxTH					<input type="checkbox"/> 18	\$795	<input type="checkbox"/> 20	\$795		

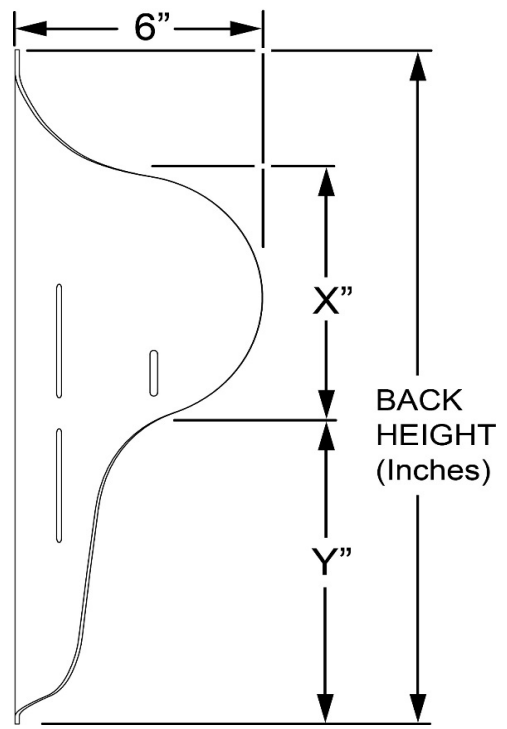

Note: Hardware choices are not offered on every size of J3 Backrest, only options listed above are available.

MOUNTING HARDWARE OPTIONS			
SH		TH	
FS		SH	



JAY® J3 Posterior Deep Contour (PDC) Backrest

E2620

January 2017

Mark For: Date: _____ Dealer Acct #: _____ Dealer: _____ Dealer Contact: _____ Dealer Address: _____ Dealer City: _____ ST: _____ ZIP: _____ Dealer Phone: () _____ Fx () _____ Confirmation Email: _____ Confirm Via: <input type="checkbox"/> Fax <input type="checkbox"/> Email	Submitting for: <input type="checkbox"/> Quote <input type="checkbox"/> Order PO#: _____ <p style="text-align: center;">ADDITIONAL SHIPPING INFORMATION</p> Ship To: _____ Attention: _____ Address: _____ Address: _____ Ship To City: _____ ST: _____ ZIP: _____ Ship To Phone: () _____ Fax () _____
--	--

The **HCPCS CODES** provided are based on code verification through PDAC or our interpretation of the code definitions.
 The use of **HCPCS CODES** does not ensure coverage or payment. For coverage information, verify the appropriate payer's coverage policy.

JAY J3 Posterior Deep Contour BACK - E2620



BACKREST WIDTH	14"	16"	18"	20"
BACKCANE WIDTHS	14"- 16"	16"- 18"	18"- 20"	20"- 22"
MAX. USER TRUNK WIDTH	11"	13"	15"	17"

		Lower Thoracic (LT)		Mid Thoracic (MT)		Upper Thoracic (UT)		Shoulder Height (SH)																
		X	Y	X	Y	X	Y	X	Y															
Back Height		6.5" (S)																						
		8.0" (M)	5"	.5"	J3PDCCLTMxxSH	<input type="checkbox"/> 14	\$750	<input type="checkbox"/> 16	\$750	<input type="checkbox"/> 18	\$750													
					J3PDCCLTMxxRH	<input type="checkbox"/> 14	\$750	<input type="checkbox"/> 16	\$750	<input type="checkbox"/> 18	\$750													
					J3PDCCLTMxxRHF	<input type="checkbox"/> 14	\$750	<input type="checkbox"/> 16	\$750	<input type="checkbox"/> 18	\$750													
		9.5" (T)	5.2"	.5"	J3PDCCLTTxxSH	<input type="checkbox"/> 14	\$750	<input type="checkbox"/> 16	\$750	<input type="checkbox"/> 18	\$750	<input type="checkbox"/> 20	\$750											
					J3PDCCLTTxxRH	<input type="checkbox"/> 14	\$750	<input type="checkbox"/> 16	\$750	<input type="checkbox"/> 18	\$750	<input type="checkbox"/> 20	\$750											
	J3PDCCLTTxxRHF				<input type="checkbox"/> 14	\$750	<input type="checkbox"/> 16	\$750	<input type="checkbox"/> 18	\$750	<input type="checkbox"/> 20	\$750												
		12.0" (S)	5.5"	.5"	J3PDCMSTxxSH	<input type="checkbox"/> 14	\$750	<input type="checkbox"/> 16	\$750	<input type="checkbox"/> 18	\$750	<input type="checkbox"/> 20	\$750											
					J3PDCMSTxxFS	<input type="checkbox"/> 14	\$790	<input type="checkbox"/> 16	\$790	<input type="checkbox"/> 18	\$790	<input type="checkbox"/> 20	\$790											
					J3PDCMSTxxTH	<input type="checkbox"/> 14	\$795	<input type="checkbox"/> 16	\$795	<input type="checkbox"/> 18	\$795	<input type="checkbox"/> 20	\$795											
		13.5" (M)																						
														15.0" (T)	6.5"	.5"	J3PDCMTTxxSH	<input type="checkbox"/> 14	\$750	<input type="checkbox"/> 16	\$750	<input type="checkbox"/> 18	\$750	<input type="checkbox"/> 20
J3PDCMTTxxFS																	<input type="checkbox"/> 14	\$790	<input type="checkbox"/> 16	\$790	<input type="checkbox"/> 18	\$790	<input type="checkbox"/> 20	\$790
J3PDCMTTxxTH	<input type="checkbox"/> 14	\$795	<input type="checkbox"/> 16	\$795	<input type="checkbox"/> 18	\$795	<input type="checkbox"/> 20	\$795																
	16.5" (S)																							
	18.0" (M)	6.5"	.5"	J3PDCUTMxxSH	<input type="checkbox"/> 14	\$750	<input type="checkbox"/> 16	\$750	<input type="checkbox"/> 18	\$750	<input type="checkbox"/> 20	\$750												
				J3PDCUTMxxFS	<input type="checkbox"/> 14	\$790	<input type="checkbox"/> 16	\$790	<input type="checkbox"/> 18	\$790	<input type="checkbox"/> 20	\$790												
				J3PDCUTMxxTH	<input type="checkbox"/> 14	\$795	<input type="checkbox"/> 16	\$795	<input type="checkbox"/> 18	\$795	<input type="checkbox"/> 20	\$795												
19.5" (T)																								
	21.0" (S)	6.5"	.5"	J3PDCSHSxxSH			<input type="checkbox"/> 16	\$750	<input type="checkbox"/> 18	\$750	<input type="checkbox"/> 20	\$750												
				J3PDCSHSxxFS			<input type="checkbox"/> 16	\$790	<input type="checkbox"/> 18	\$790	<input type="checkbox"/> 20	\$790												
				J3PDCSHSxxTH			<input type="checkbox"/> 16	\$795	<input type="checkbox"/> 18	\$795	<input type="checkbox"/> 20	\$795												
	22.5" (M)																							
24.0" (T)																								

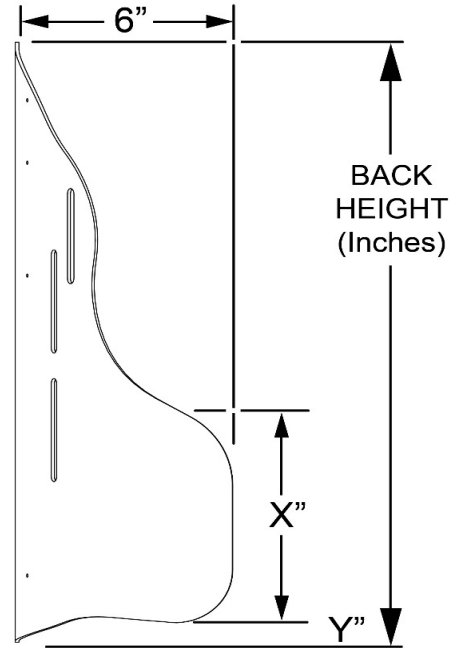

Note: Hardware choices are not offered on every size of J3 Backrest, only options listed above are available.

MOUNTING HARDWARE OPTIONS

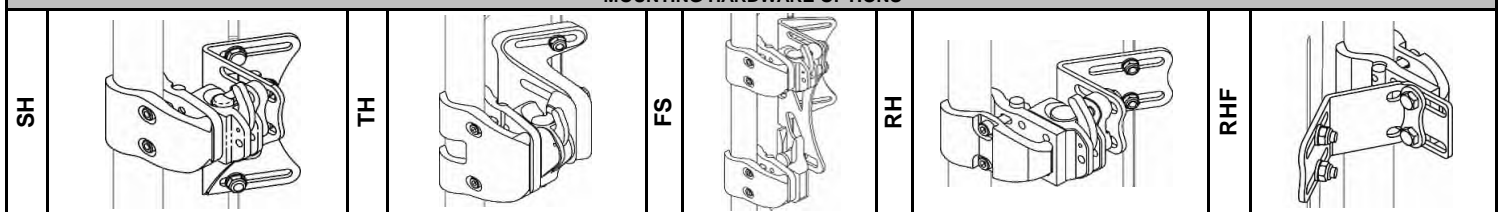

JAY J3 BACK ACCESSORIES

All JAY J3 Back accessories are optional. All accessories will be factory mounted as much as possible to insure proper shipping (If selected below).

SHIPPING INSTRUCTIONS

<input type="checkbox"/>	N/A	Ship Back on Chair (Chair to be ordered separately)	N/C	<input type="checkbox"/>	N/A	Ship accessories mounted on back	N/C		
✓	Option #	HCPCS	Definition	Price	✓	Option #	HCPCS	Definition	Price

HEADRESTS

Use this section for selecting headrest. Head supports are not available on LT Back Shells or 22"-26" MT Back Shells

STEP 1 - Select your HEADREST POST

Please select one box from the below **Headrest Mount & Bracket** choices.

<input type="checkbox"/>	J3HEDX	E1028	Axys Mount & Bracket	\$220.00	<input type="checkbox"/>	J3HEDO	E1028	ONYX Mount & Bracket	\$200.00
<input type="checkbox"/>	J3HEDL	E1028	LINX Mount & Bracket	\$280.00	<input type="checkbox"/>	J3HEDC	E1028	Cobra Mount & Bracket	\$280.00
<input type="checkbox"/>	J3HEDL2	E1028	LINX ² Mount & Bracket	\$310.00	<input type="checkbox"/>	J3HEDF	E1028	Cobra Flip Back Mount and Bracket	\$350.00



STEP 2 - Select your HEADREST PAD

Please select one box from the below **Headrest Pad** choices.

<input type="checkbox"/>	14	E0955	J3PLSH14 - 14" Plush Pad	\$174.00	<input type="checkbox"/>	AAPS	E0955	J3AAPS - Adjust-A-Plush Standard (Lo)	\$260.00
<input type="checkbox"/>	10	E0955	J3PLSH10 - 10" Plush Pad	\$161.00	<input type="checkbox"/>	AAPM	E0955	J3AAPS - Adjust-A-Plush Medium NEW!	\$260.00
<input type="checkbox"/>	8	E0955	J3PLSH8 - 8" Plush Pad	\$161.00	<input type="checkbox"/>	AAPN	E0955	J3AAPN - Adjust-A-Plush Narrow (Sm)	\$260.00
<input type="checkbox"/>	HUPL	E0955	J3HUPL - HeadsUp Lrg: 5.3" Lng Arms	\$310.00	<input type="checkbox"/>	CL	E0955	J3CRDLLG - Lrg Contour Cradle Pad	\$155.00
<input type="checkbox"/>	HUPM	E0955	J3HUPM - HeadsUp Med: 4.1" Sht Arms	\$310.00	<input type="checkbox"/>	CM	E0955	J3CRDLMD - Med Contour Cradle Pad	\$143.00
<input type="checkbox"/>	HUPS	E0955	J3HUPS - HeadsUp Sml: 3.5" Sht Arms	\$310.00	<input type="checkbox"/>	PL	E0955	J3CPLULG - Large C-Plush Pad	\$155.00
					<input type="checkbox"/>	PM	E0955	J3CPLUMD - Medium C-Plush Pad	\$155.00



STEP 1 - Headrest Post Example = J3HEDX	+	STEP 2 - Headrest Pad # Example = 14	=	Completed JAY J3 Headrest # Example = J3HEDX14
---	---	--	---	--

UNIVERSAL MOUNTING PLATE

<input type="checkbox"/>	J3UHM	K0108	Universal Headrest Mounting Plate Only	\$52.00
--------------------------	-------	-------	--	---------

LATERAL SUPPORTS

Use this section for selecting laterals and hardware. Lateral supports are not available on Lower Thoracic Back Shells or 22"-26" MT Back Shells

JAY CradleU LATERAL

JAY's CradleU Lateral allows you to optimize the contour and provides lateral support behind the backrest cover

<input type="checkbox"/>	ADD "CU"	E0956	JAY CradleU Lateral	\$250.00
--------------------------	----------	-------	---------------------	----------

To order add "CU" to the end of your J3 back part number

The CradleU ships installed on the backrest

Only available with 16", 18" & 20" back widths

Not available with LT, PD, & PDL Back Shells

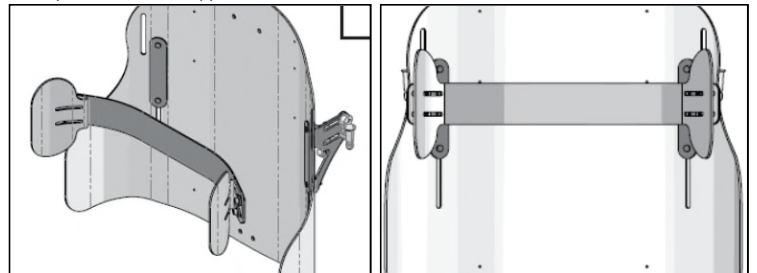

LATERAL SUPPORTS Continued

Use this section for selecting laterals and hardware. Lateral supports are not available on Lower Thoracic Back Shells or 22"-26" MT Back Shells

LATERAL THORACIC SUPPORT (Fixed)

Includes fixed mounting hardware. Lateral pads use 3DX covers with 1/2" Sunmate foam in the core

<input type="checkbox"/>	J3LAT4X4FX	E0956	LATERAL 4" Depth X 4" Height FIXED	\$251.00	<input type="checkbox"/>	J3LAT6X4FX	E0956	LATERAL 6" Depth X 4" Height FIXED	\$251.00
<input type="checkbox"/>	J3LAT4X5FX	E0956	LATERAL 4" Depth X 5" Height FIXED	\$251.00	<input type="checkbox"/>	J3LAT6X5FX	E0956	LATERAL 6" Depth X 5" Height FIXED	\$251.00
<input type="checkbox"/>	J3LAT4x6FX	E0956	LATERAL 4" Depth X 6" Height FIXED	\$251.00	<input type="checkbox"/>	J3LAT6X6FX	E0956	LATERAL 6" Depth X 6" Height FIXED	\$251.00

LATERAL THORACIC SUPPORT (Swing Away)

Includes swing-away mounting hardware. Lateral pads use 3DX covers with 1/2" Sunmate foam in the core

<input type="checkbox"/>	J3LAT4X4SA		LAT 4X4 W/ S/A MOUNTS - PR	\$778.00	<input type="checkbox"/>	J3LAT6X4SA		LAT 6X4 W/ S/A MOUNTS - PR	\$778.00
	J3LAT4X4	E0956	LATERAL 4" Depth X 4" Height - PAIR	\$251.00		J3LAT6X4	E0956	LATERAL 6" Depth X 4" Height - PAIR	\$251.00
	J3SAMNT	E1028	LATERAL SWING AWAY MOUNT - PAIR	\$527.00		J3SAMNT	E1028	LATERAL SWING AWAY MOUNT - PAIR	\$527.00
<input type="checkbox"/>	J3LAT4X5SA		LAT 4X5 W/ S/A MOUNTS - PR	\$778.00	<input type="checkbox"/>	J3LAT6X5SA		LAT 6X5 W/ S/A MOUNTS - PR	\$778.00
	J3LAT4X5	E0956	LATERAL 4" Depth X 5" Height - PAIR	\$251.00		J3LAT6X5	E0956	LATERAL 6" Depth X 5" Height - PAIR	\$251.00
	J3SAMNT	E1028	LATERAL SWING AWAY MOUNT - PAIR	\$527.00		J3SAMNT	E1028	LATERAL SWING AWAY MOUNT - PAIR	\$527.00
<input type="checkbox"/>	J3LAT4X6SA		LAT 4X6 W/ S/A MOUNTS - PR	\$778.00	<input type="checkbox"/>	J3LAT6X6SA		LAT 6X6 W/ S/A MOUNTS - PR	\$778.00
	J3LAT4X6	E0956	LATERAL 4" Depth X 6" Height - PAIR	\$251.00		J3LAT6X6	E0956	LATERAL 6" Depth X 6" Height - PAIR	\$251.00
	J3SAMNT	E1028	LATERAL SWING AWAY MOUNT - PAIR	\$527.00		J3SAMNT	E1028	LATERAL SWING AWAY MOUNT - PAIR	\$527.00
<input type="checkbox"/>	J3LAT4X4SAO		LAT 4X4 S/A MOUNTS W/ 1" OFFSET - PR	\$778.00	<input type="checkbox"/>	J3LAT6X4SAO		LAT 6X4 S/A MOUNTS W/ 1" OFFSET - PR	\$778.00
	J3LAT4X4O	E0956	LATERAL 4" D X 4" H W/ 1" OFFSET - PAIR	\$251.00		J3LAT6X4O	E0956	LATERAL 6" D X 4" H W/ 1" OFFSET - PAIR	\$251.00
	J3SAMNT	E1028	LATERAL SWING AWAY MOUNT - PAIR	\$527.00		J3SAMNT	E1028	LATERAL SWING AWAY MOUNT - PAIR	\$527.00
<input type="checkbox"/>	J3LAT4X5SAO		LAT 4X5 S/A MOUNTS W/ 1" OFFSET - PR	\$778.00	<input type="checkbox"/>	J3LAT6X5SAO		LAT 6X5 S/A MOUNTS W/ 1" OFFSET - PR	\$778.00
	J3LAT4X5O	E0956	LATERAL 4" D X 5" H W/ 1" OFFSET - PAIR	\$251.00		J3LAT6X5O	E0956	LATERAL 6" D X 5" H W/ 1" OFFSET - PAIR	\$251.00
	J3SAMNT	E1028	LATERAL SWING AWAY MOUNT - PAIR	\$527.00		J3SAMNT	E1028	LATERAL SWING AWAY MOUNT - PAIR	\$527.00
<input type="checkbox"/>	J3LAT4X6SAO		LAT 4X6 S/A MOUNTS W/ 1" OFFSET - PR	\$778.00	<input type="checkbox"/>	J3LAT6X6SAO		LAT 6X6 S/A MOUNTS W/ 1" OFFSET - PR	\$778.00
	J3LAT4X6O	E0956	LATERAL 4" D X 6" H W/ 1" OFFSET - PAIR	\$251.00		J3LAT6X6O	E0956	LATERAL 6" D X 6" H W/ 1" OFFSET - PAIR	\$251.00
	J3SAMNT	E1028	LATERAL SWING AWAY MOUNT - PAIR	\$527.00		J3SAMNT	E1028	LATERAL SWING AWAY MOUNT - PAIR	\$527.00

SPINE ALIGN POSITIONING COMPONENTS

J3 Back LT models come standard with a Small Lumbar, MT, UT and SH models come standard with a small and large lumbar.

SPINE-ALIGN MINI FIT KIT 1

Includes: 3 wedges, 2 lateral shims, and 2 posterior/lateral pelvic positioning pads.

<input type="checkbox"/>	J3SPNK112	K0108	SPINE-ALIGN MINI FIT KIT 1 (12")	\$101.00
<input type="checkbox"/>	J3SPNK114	K0108	SPINE-ALIGN MINI FIT KIT 1 (14")	\$101.00
<input type="checkbox"/>	J3SPNK116	K0108	SPINE-ALIGN MINI FIT KIT 1 (16")	\$101.00
<input type="checkbox"/>	J3SPNK118	K0108	SPINE-ALIGN MINI FIT KIT 1 (18")	\$101.00
<input type="checkbox"/>	J3SPNK120	K0108	SPINE-ALIGN MINI FIT KIT 1 (20")	\$101.00
<input type="checkbox"/>	J3SPNK122	K0108	SPINE-ALIGN MINI FIT KIT 1 (22"-26")	\$101.00

SPINE-ALIGN MINI FIT KIT 2

Includes: 5 wedges, 2 lat shims, 2 post/lat pelvic, 1 lg lumbar, 1 flat shim, and 1 curved

<input type="checkbox"/>	J3SPNK212	K0108	SPINE-ALIGN MINI FIT KIT 2 (12")	\$139.00
<input type="checkbox"/>	J3SPNK214	K0108	SPINE-ALIGN MINI FIT KIT 2 (14")	\$139.00
<input type="checkbox"/>	J3SPNK216	K0108	SPINE-ALIGN MINI FIT KIT 2 (16")	\$139.00
<input type="checkbox"/>	J3SPNK218	K0108	SPINE-ALIGN MINI FIT KIT 2 (18")	\$139.00
<input type="checkbox"/>	J3SPNK220	K0108	SPINE-ALIGN MINI FIT KIT 2 (20")	\$139.00
<input type="checkbox"/>	J3SPNK222	K0108	SPINE-ALIGN MINI FIT KIT 2 (22"-26")	\$139.00

LARGE LUMBAR PADS (Back Width) (W" x H" x D")

<input type="checkbox"/>	J3SPNLL12	K0108	LG LUMBAR (12") (3.5" x 7" x 1.6")	\$44.00
<input type="checkbox"/>	J3SPNLL14	K0108	LG LUMBAR (14") (3.5" x 7" x 1.6")	\$44.00
<input type="checkbox"/>	J3SPNLL16	K0108	LG LUMBAR (16") (5.5" x 7" x 1.6")	\$44.00
<input type="checkbox"/>	J3SPNLL18	K0108	LG LUMBAR (18") (7.5" x 7" x 1.6")	\$44.00
<input type="checkbox"/>	J3SPNLL20	K0108	LG LUMBAR (20") (9.5" x 7" x 1.6")	\$44.00
<input type="checkbox"/>	J3SPNLL22	K0108	LG LUMBAR (22"-26") (9.5" x 7" x 1.6")	\$44.00

SMALL LUMBAR PADS (Back Width) (W" x H" x D")









<input type="checkbox"/>	J3SPNSL12	K0108	SML LUMBAR (12") (1.8" x 3.2" x 0.8")	\$42.00
<input type="checkbox"/>	J3SPNSL14	K0108	SML LUMBAR (14") (3.5" x 4.3" x 1")	\$42.00
<input type="checkbox"/>	J3SPNSL16	K0108	SML LUMBAR (16") (5.5" x 4.3" x 1")	\$42.00
<input type="checkbox"/>	J3SPNSL18	K0108	SML LUMBAR (18") (7.5" x 4.3" x 1")	\$42.00
<input type="checkbox"/>	J3SPNSL20	K0108	SML LUMBAR (20") (9.5" x 4.3" x 1")	\$42.00
<input type="checkbox"/>	J3SPNSL22	K0108	SML LUMBAR (22"-26") (9.5" x 4.3" x 1")	\$42.00

WEDGES (Back Width) (W" x H" x D")

<input type="checkbox"/>	J3SPNWE12	K0108	WEDGES (12") (3.5" x 6.5" x 1.6")	\$32.00
<input type="checkbox"/>	J3SPNWE14	K0108	WEDGES (14") (3.5" x 6.5" x 1.6")	\$32.00
<input type="checkbox"/>	J3SPNWE16	K0108	WEDGES (16") (5.5" x 6.5" x 1.6")	\$32.00
<input type="checkbox"/>	J3SPNWE18	K0108	WEDGES (18") (7.5" x 6.5" x 1.6")	\$32.00
<input type="checkbox"/>	J3SPNWE20	K0108	WEDGES (20") (9.5" x 6.5" x 1.6")	\$32.00
<input type="checkbox"/>	J3SPNWE22	K0108	WEDGES (22"-26") (9.5" x 6.5" x 1.6")	\$32.00

OTHER INDIVIDUAL SPINE-ALIGN COMPONENTS

<input type="checkbox"/>	J3SPNCR	K0108	Curved Shim	\$25.00
<input type="checkbox"/>	J3SPNBS	K0108	Small Bean Bag	\$27.00
<input type="checkbox"/>	J3SPNFL	K0108	Flat Shim	\$25.00
<input type="checkbox"/>	J3SPNBL	K0108	Large Bean Bag	\$29.00
<input type="checkbox"/>	J3SPNLS	K0108	Lateral Shim	\$47.00
<input type="checkbox"/>	J3SPNLP	K0108	Posterior/Lateral Pelvic	\$47.00

									
	Sm Lumbar	Lg Lumbar	Wedge	Curved Slim	Flat	Lateral Slim	Sm Bean Bag	Lg Bean Bag	Post/Lat Pelvic
W	1.8" - 9.5"	3.5" - 9.5"	3.5" - 9.5"	10"	10"	2.4"	6"	10"	5.3"
H	3.2" - 4.3"	7"	6.5"	4"	4"	4.3"	4.5"	3.2"	3.6"
D	0.8" - 1"	1.6"	1.6"	0.5"	0.3"	0.5"	0.75"	0.75"	0.75"

CHEST STRAPS, HARNESSSES, and BRACKETS

Use this section for selecting harnesses. Harnesses are not available on Lower Thoracic Back Shells or 22"-26" MT Back Shells

CHEST STRAPS & HARNESSSES (Includes strap guides & mounting hardware)

<input type="checkbox"/>	J3HRNCOS	E0960	Center Opening w/ Buckle (Sml)	\$187.00	<input type="checkbox"/>	J3HRNTDS	E0960	Contoured-Dynamic Pull Down (Sml)	\$187.00
<input type="checkbox"/>	J3HRNCOM	E0960	Center Opening w/ Buckle (Med)	\$187.00	<input type="checkbox"/>	J3HRNTDM	E0960	Contoured-Dynamic Pull Down (Med)	\$187.00
<input type="checkbox"/>	J3HRNCOL	E0960	Center Opening w/ Buckle (Lrg)	\$187.00	<input type="checkbox"/>	J3HRNTDL	E0960	Contoured-Dynamic Pull Down (Lrg)	\$187.00
<input type="checkbox"/>	J3HRNCOX	E0960	Center Opening w/ Buckle (X-Lrg)	\$187.00	<input type="checkbox"/>	J3HRNTDX	E0960	Contoured-Dynamic Pull Down (X-Lrg)	\$187.00
<input type="checkbox"/>	J3HRNCDS	E0960	Classic-Dynamic Pull Down (Sml)	\$187.00	<input type="checkbox"/>	J3HRNTSS	E0960	Contoured-Structured Pull Down (Sml)	\$187.00
<input type="checkbox"/>	J3HRNCDM	E0960	Classic-Dynamic Pull Down (Med)	\$187.00	<input type="checkbox"/>	J3HRNTSM	E0960	Contoured-Structured Pull Down (Med)	\$187.00
<input type="checkbox"/>	J3HRNCDL	E0960	Classic-Dynamic Pull Down (Lrg)	\$187.00	<input type="checkbox"/>	J3HRNTSL	E0960	Contoured-Structured Pull Down (Lrg)	\$187.00
<input type="checkbox"/>	J3HRNCDX	E0960	Classic-Dynamic Pull Down (X-Lrg)	\$187.00	<input type="checkbox"/>	J3HRNTSX	E0960	Contoured-Structured Pull Down (X-Lrg)	\$187.00
<input type="checkbox"/>	J3HRNCSS	E0960	Classic-Structured Pull Down (Sml)	\$187.00	<input type="checkbox"/>	J3HRNPSS	E0960	Padded Anterior Trunk Straps (Sml)	\$187.00
<input type="checkbox"/>	J3HRNCSM	E0960	Classic-Structured Pull Down (Med)	\$187.00	<input type="checkbox"/>	J3HRNPMS	E0960	Padded Anterior Trunk Straps (Med)	\$187.00
<input type="checkbox"/>	J3HRNCSL	E0960	Classic-Structured Pull Down (Lrg)	\$187.00	<input type="checkbox"/>	J3HRNPXL	E0960	Padded Anterior Trunk Straps (Lrg)	\$187.00
<input type="checkbox"/>	J3HRNC SX	E0960	Classic-Structured Pull Down (X-Lrg)	\$187.00	<input type="checkbox"/>	J3HRNP SX	E0960	Padded Anterior Trunk Straps (X-Lrg)	\$187.00

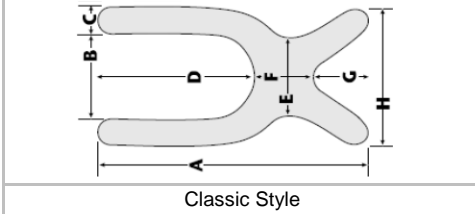

	A	B	C	D	E	F	G	H
S	15"	4.5"	2"	9"	4"	4"	2"	8.5"
M	19"	5.5"	2"	11"	5"	5"	3"	9.5"
L	22.5"	6.5"	2"	13"	6"	6"	3.5"	10.5"
XL	25.5"	6.5"	2.5"	14"	7"	7"	4.5"	11.5"

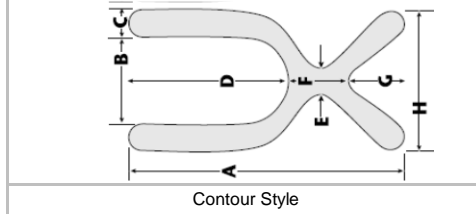

	A	B	C	D	E	F	G	H
S	15"	4.5"	2"	9"	1"	4"	2"	8.5"
M	18.5"	5.5"	2"	11"	1"	5"	2.5"	9.5"
L	22.5"	6.5"	2"	13"	1.5"	6"	3.5"	10.5"
XL	25.5"	6.5"	2.5"	14"	1.5"	7"	4.5"	11.5"

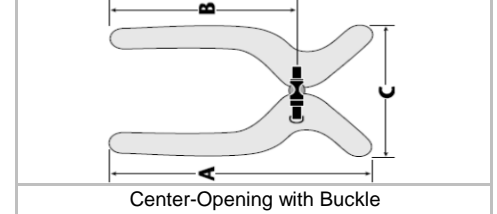

	A	B	C
S	12.3"	9"	6.5"
M	14.3"	11"	9.8"
L	15.5"	11.5"	9.8"
XL	17.5"	12.8"	10"

GUIDE BRACKETS & HARDWARE ONLY

<input type="checkbox"/>	J3GPSG	K0108	Guide Brackets Only - Pair	\$41.00	<input type="checkbox"/>	J3HHP	K0108	Hardware Pack Only	\$20.00
--------------------------	--------	-------	----------------------------	---------	--------------------------	-------	-------	--------------------	---------

VANITY FLAP

All 22"-26" wide J3 Back shells ship standard with the vanity flap included

<input type="checkbox"/>	117096	K0108	12" to 14" Wide	\$45.00	<input type="checkbox"/>	117100	K0108	20" to 22" Wide	\$45.00
<input type="checkbox"/>	117097	K0108	14" to 16" Wide	\$45.00	<input type="checkbox"/>	117101	K0108	22" to 24" Wide	\$45.00
<input type="checkbox"/>	117098	K0108	16" to 18" Wide	\$45.00	<input type="checkbox"/>	117102	K0108	24" to 26" Wide	\$45.00
<input type="checkbox"/>	117099	K0108	18" to 20" Wide	\$45.00	<input type="checkbox"/>	117103	K0108	26" to 28" Wide	\$45.00

INNER COVER

To order a optional inner cover enter a additional line item by adding "IC" to the front of your desired J3 back part number and remove your hardware suffix.

<input type="checkbox"/>	Add "IC"	K0108	Inner Cover	\$125.00
--------------------------	----------	-------	-------------	----------

JAY YOUR WAY MODIFICATIONS

Note: To order sizes offered via JAY Your Way add a "M" to the front of the part number and follow the prompts.

For additional modifications visit www.sunrisemedical.com to view even more!

PAINTED BACK SHELL

<input type="checkbox"/>	SBC	Painted Back Shell	NC
Color:		<input type="checkbox"/> Match Quickie or Zippie Frame Color	

Note: Backshells can be painted any Quickie Or Zippie Frame color at no charge please specify the desired color in the NOTES box below. For a full listing of frame colors available please visit www.sunrisemedical.com

MILITARY SERVICE PATCHES

<input type="checkbox"/>	VAPH	Purple Heart Service Patch	NC
<input type="checkbox"/>	VAM	Marine Service Patch	NC
<input type="checkbox"/>	VAA	Army Service Patch	NC
<input type="checkbox"/>	VAAF	Air Force Service Patch	NC
<input type="checkbox"/>	VAN	Navy Service Patch	NC
<input type="checkbox"/>	VACG	Coast Guard Service Patch	NC

CUSTOM EMBROIDERY

<input type="checkbox"/>	EMBROIDERY	K0108	Embroidery (32 Character Max)	\$22.00
Location: <input type="checkbox"/> Front				
Font: <input type="checkbox"/> Block <input type="checkbox"/> Script				

Embroidery Text:

COVER COLOR OPTIONS - Rear Center Flap

<input type="checkbox"/>	DCC	Digital Camouflage Cover	NC
--------------------------	-----	--------------------------	----

SPINAL FLUID PAD

<input type="checkbox"/>	SFPS	Small Spinal Fluid Pad (16" Height)	\$50.00
<input type="checkbox"/>	SFPM	Medium Spinal Fluid Pad (18" Height)	\$50.00
<input type="checkbox"/>	SFPT	Tall Spinal Fluid Pad (20" Height)	\$50.00
<input type="checkbox"/>	SFPXT	Extra Tall Spinal Fluid Pad (23" Height)	\$50.00

VISCO FOAM INSERT

<input type="checkbox"/>	VF	Visco Foam Insert	\$50.00
<input type="checkbox"/>	VFWSR	Visco Foam Insert with Spinal Relief	\$50.00

Note: 2 Layers of 1" Yellow Visco foam is utilized as standard. Different colors of visco foam can be utilized just list desired color in notes below.

Don't see the option you want? NO PROBLEM! Write your request below and we can evaluate it and provide a quote.

Notes: